

2020|IT
**CATALOGO
DENTALE**

ASA DENTAL

ASA DENTAL
MAKE PEOPLE SMILE

VI PRESENTIAMO LA NOSTRA RACCOLTA
COMPLETA DI STRUMENTI E PRODOTTI
MONOUSO GRAZIE AI QUALI SIAMO
RIUSCITI AD AFFERMARE IL MARCHIO
ASA DENTAL IN OGNI PAESE DEL MONDO.

DA SEMPRE LA NOSTRA ISPIRAZIONE
SI BASA SU UN CONCETTO SEMPLICE:
AIUTARE LE PERSONE A SORRIDERE.

PER FARLO, ABBIAMO DEDICATO TUTTO
IL NOSTRO IMPEGNO NELLA PRODUZIONE
DI PRODOTTI SEMPRE PIÙ
ALL'AVANGUARDIA, CON LO SCOPO
DI MIGLIORARE LA QUALITÀ
DELLA VITA DI MILIONI DI PAZIENTI.

INDICE

4 9	CORPORATE
10 13	INDICE DEI NOMI SCIENTIFICI
A1 A23	MONOUSO ASAONE
B1 B25	DIAGNOSTICA
C1 C47	CHIRURGIA ORALE
D1 D71	CHIRURGIA ESTRATTIVA
E1 E41	CHIRURGIA IMPLANTARE
F1 F51	CONSERVATIVA
G1 G37	PARODONTOLOGIA
H1 H37	ORTODONZIA
I1 I19	VASSOI E CONTENITORI
J1 J43	PORTAIMPRONTA
K1 K35	STRUMENTI PER LABORATORIO
14 47	INDICE DEI CODICI
48 52	INDICE DEI PRODOTTI

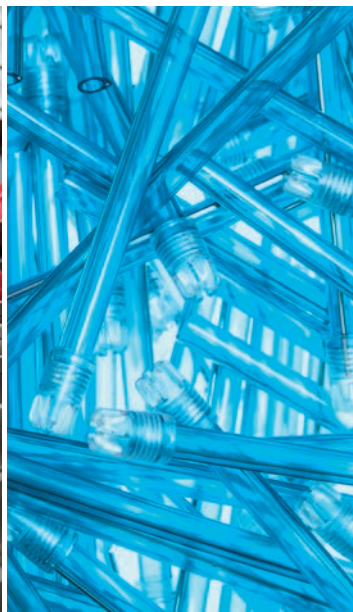

1961
FONDAZIONE
L'intuizione di Aldo Puccetti diventa realtà imprenditoriale. Nasce Asa Dental

1975
MARLIA
Inizia la produzione nello stabilimento di Marlia per soddisfare la crescente richiesta da parte dai mercati

2004
KALTOPLAST
Con l'acquisizione di Kaltoplast, Asa Dental consolida la posizione di leader nel segmento di aspirasaliva monouso

2010
ASA DENTAL USA
L'azienda rafforza la propria posizione internazionale con l'apertura della filiale negli Stati Uniti

2013
ASA DENTAL CINA
Diventa operativa la filiale cinese del gruppo con l'obiettivo di servire uno dei mercati più importanti per dimensioni e velocità di crescita

2015
BOZZANO
Inaugurazione del magazzino verticale automatizzato grazie al quale il nuovo centro di logistica migliora l'efficienza e riduce i tempi di consegna in tutto il mondo

2018
DUBAI
Asa Dental inaugura la filiale di Dubai e consolida le attività a supporto di tutta l'area mediorientale

1965
MANIAGO
Viene inaugurato lo stabilimento di Maniago. La produzione di strumenti in acciaio affianca quella di prodotti monouso, a completamento dell'offerta aziendale

2001
DERBY DENTAL
Asa Dental acquisisce Derby Dental e aggiunge nuovi prodotti alla propria offerta

2009
ALESSANDRO Malfatti
Dal presente al futuro: Alessandro Malfatti diventa il nuovo General Manager

2012
ASAONE
Investimenti a supporto dell'efficienza produttiva e operativa incrementano la competitività dei prodotti monouso

2014
MANIAGO
Gli stabilimenti di Maniago incrementano la capacità produttiva e migliorano la qualità degli strumenti in acciaio inossidabile

2016
EDUCATIONAL CENTER
Nasce l'Educational Center con lo scopo di collegare opinion leaders, università e professionisti

2019
DIGITAL INTEGRATION
La tecnologia digitale collega progettazione, sviluppo e comunicazione di prodotto in modo semplice e intuitivo

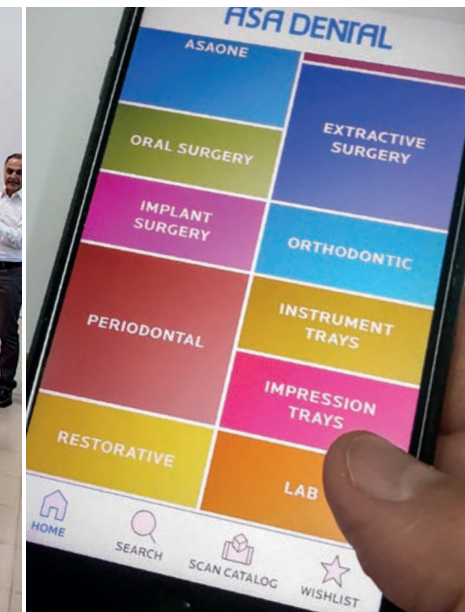

NETWORK MONDIALE

La missione aziendale di aiutare le persone a sorridere, ovunque nel mondo, implica vivere a stretto contatto con i professionisti del settore, comprendere le differenze tra i vari mercati e progettare prodotti e servizi su misura per ogni dentista, odontotecnico e assistente.

Grazie a una presenza internazionale strutturata, con filiali negli Stati Uniti, in Cina e negli Emirati Arabi, Asa Dental può operare con la massima efficienza su scala globale e allo stesso tempo rispettare le diverse esigenze di ogni singolo mercato. La sede centrale italiana coordina la produzione, la vendita e la logistica combinando innovazione e tradizione attraverso la progettazione creativa e la produzione esperta, gli ingredienti per la ricetta autentica del moderno del *Made in Italy*.

Il nostro impegno è ripagato dalla consapevolezza che, con i nostri prodotti, i professionisti del settore possono migliorare la qualità di vita di milioni di pazienti in oltre 170 paesi, aiutandoci a tener fede alla nostra missione e rendendo la pratica dentale accessibile a chiunque.

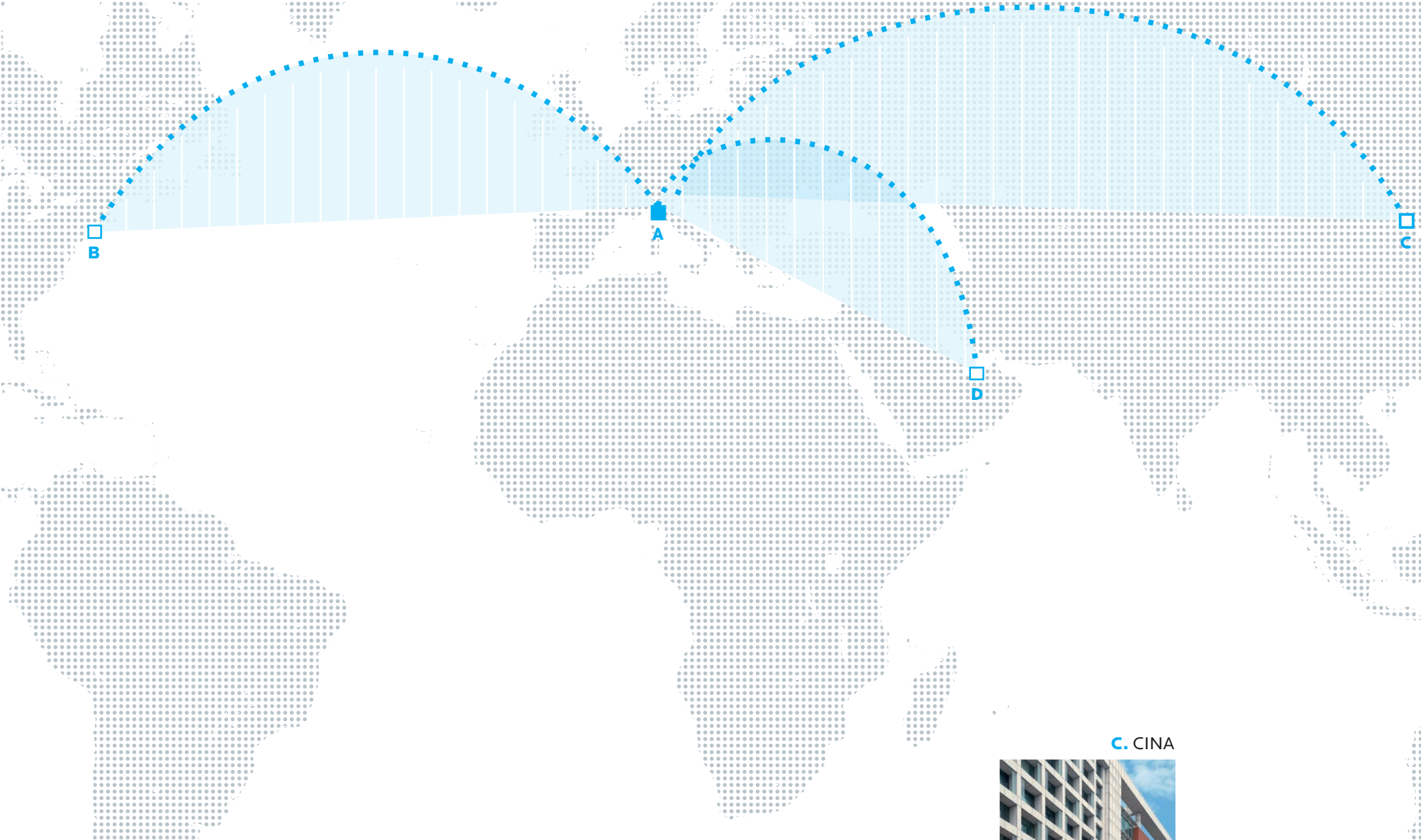

C. CINA

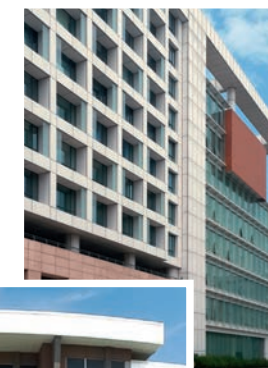

D. EMIRATI ARABI



B. STATI UNITI



A. ITALIA



INNOVAZIONE E TRADIZIONE

Asa Dental ha da sempre dedicato gran parte delle sue risorse alla produzione dei propri dispositivi.

Invertendo il trend mondiale di delocalizzazione produttiva, abbiamo scelto di concentrare in Italia l'intera produzione aziendale, in modo da garantire ai nostri clienti un eccellente livello qualitativo.

Il controllo rigoroso dell'intero processo produttivo, sia per i prodotti monouso che per gli strumenti in acciaio, ha permesso di migliorare costantemente la qualità e l'efficienza operativa.

Ciascun sito produttivo è specializzato in una linea di prodotti, in modo da accrescere le competenze specifiche del personale e ottimizzare i processi.

Indipendentemente dal tipo di prodotto, possiamo così rispondere all'evoluzione del mercato in termini di quantità, precisione e applicazione odontoiatrica.

Con centinaia di migliaia di prodotti spediti ogni anno, garantiamo un rigido controllo qualitativo e un sistema di tracciabilità scrupoloso per offrire il livello di efficacia, sicurezza e comfort che i pazienti si aspettano.



INDICE DEI NOMI SCIENTIFICI

nome scientifico	categoria di strumento	pagina
Adams	Pinze per piegare fili	H20
Aderer	Pinze per piegare fili	H21
Adson	Porta aghi	C10
	Pinzette chirurgiche	C38, E36
Adson Brown	Pinzette chirurgiche	C41
Ainsworth	Pinze per forare la diga	F8
	Pinze per forare la diga - AsaLady	F9
Allen	Scollaperiostio ed Elevatori	E23, G16
Angle	Pinze per piegare fili	H15, H19
Apexo	Leve per radici	D54, D60
Arruga	Porta aghi	C15
Backhaus	Pinze per pannilino	C31
Ball	Otturatori - Brunitori	F31
Barnhart	Curettes e Scalers	G5
Baumgartner	Porta aghi	C11
Beale	Scollaperiostio ed Elevatori	E22, G16
	Strumenti per modellare amalgama/cera	K16
Bein	Leve per radici	D47, D48, D59
Beyer	Pinze ossivore alveolotome	D44
Black	Strumenti da smalto - finitori per bordi gengivali	F18
	Strumenti da smalto - scalpelli	F19
Blumenthal	Pinze ossivore alveolotome	D43, E30
Böhm	Strumenti per corone	F43, K29
Boley	Calibri	F42, K30
Bowman	Sonde seno mascellare	C37
Brewer	Pinze per uncini	F9
Brünings	Abbassalingua	C34
Buchwald	Abbassalingua	C34
Buck	Bisturi per gengivectomia	G24, G25
Buckley	Scalpelli e sgorbie per parodontologia	G27
Buser	Dissettori	E22
	Posizionatori di membrane	E31
Castroviejo	Porta aghi	C6, C18, C19, E5, E6
Castroviejo-Barraquer	Porta aghi	C19
Cattoni	Sonde doppie	B8

nome scientifico	categoria di strumento	pagina
Chompret	Sindesmotomi	D65
	Sindesmotomi - AsaLady	D65
Cleveland	Pinze ossivore alveolotome	D42
Cleveland-Gardner	Pinze ossivore alveolotome	D42
Cogswell	Leve per radici	D54
Coleman	Leve per radici	D46
Collin	Pinze tiralingua	C33
Columbia	Curettes e Scalers	G4
	Abbassalingua	C34
Cooley	Pinzette chirurgiche	C38
Coupland	Leve per radici	D56, D58
Crane-Kaplan	Pinzette per marcare le tasche	E35
	Curettes e Scalers	G8
	Bisturi per gengivectomia	G25
	Pinzette per marcare le tasche	G31
Crile	Pinze emostatiche	C20
Crile-Wood	Porta aghi	C10, C11
Cryer	Pinze per estrazione forma americana	D28, D32
	Leve per radici	D55, D60
Curtis	Leve per radici	D53
Darby-Perry	Escavatori	F17
De La Rosa	Pinze per piegare fili	H18
De Marco	Curettes e Scalers	G5
Dean	Forbicine per gengive	C7
Delphin	Pinze per piegare fili	H10
Derf	Porta aghi	C13
Didner	Porta matrici	F46
Eiselberg-Mathieu	Porta aghi	C15
Fahnenstock	Coltelli per cera	K22
Farabeuf	Divaricatori	C35
Felt	Strumenti per composito Felt	F32
Fine Swedish	Porta aghi	C14
Flagg	Pinzette per medicazioni	B4
	Pinzette per medicazioni - AsaLady	B5
Flohr	Leve per radici	D49, D58, D59
Foc	Otturatori	F30
Frahm	Strumenti per modellare e rifinire otturazioni	F37
	Strumenti per modellare amalgama/cera	K13

nome scientifico	categoria di strumento	pagina
Frazier	Cannule chirurgiche	C44
Freer	Scalpelli chirurgici	E16
	Scollaperiostio ed Elevatori	E24, G17
Friedman	Leve per radici	D57
	Pinze ossivore alveolotome	D42
Furrer	Pinze per togliere anelli di rame	F43
Gardner	Scalpelli e sgorbie per parodontologia	G27
Gillies	Porta aghi	C14
Goldman-Fox	Pinze per tessuti	E29, D44
	Combinazioni sonde - Sonde millimetriche	B10
	Curettes e Scalers	G6
	Bisturi per gengivectomia	G25
	Forbicine per gengive	C3, C4, E4
	Sonde millimetriche parodontali	G3
	Pinze per tessuti	G30
	Scollaperiostio ed Elevatori	E22
Goldman-Fox (Crane-Kaplan)	Pinzette per marcare le tasche	B3, E35, G31
Goldman-Fox (special)	Forbicine per gengive	C4
Goldman-Fox Williams	Combinazioni sonde - Sonde millimetriche	B11
Gracey	Curettes Gracey	G11
	Curettes Gracey - AF	G12
	Curettes Gracey - MF	G13
Greenstein	Strumenti per ceramica e resine di rivestimento	K21
Gritman	Coltelli per gessi	K23
	Strumenti per modellare amalgama/cera	K16
Gross-Maier	Pinze porta tamponi	C32
Halsey	Porta aghi	C13
Halsey-Smooth	Porta aghi	C13
Halstead-Mosquito	Pinze emostatiche	C21
	Pinze emostatiche - AsaLady	C21
	Pinze emostatiche	F44
	Pinzette per elastici	H36
Harris	Pinze per estrazione forma americana	D26
	Pinze per estrazione forma americana - AsaLady	D30
Hartmann	Pinze emostatiche	C23
Hegar-Baumgartner	Porta aghi	C11
Heidbrink	Leve per radici	D54, D60
	Mini leve per frammenti di radici	D63, D64

nome scientifico	categoria di strumento	pagina
Heidemann	Spatole	F23, F24
	Spatole - AsaLady	F24
Hemingway	Cucchiai alveolari	C45, E21, G20
Herbert	Martelli chirurgici	G29
Hirschfeld	Lime	G22
Hollenback	Strumenti per modellare e rifinire otturazioni	F36
	Otturatori per amalgama	F28
	Strumenti per modellare amalgama/cera	K13
Hopkins	Scollaperiostio ed Elevatori	E24, G17
How	Pinze per piegare fili	H23
Hourigan	Scollaperiostio ed Elevatori	E23, G16
Hull	Pinze per estrazione forma americana	D27
	Pinze per estrazione forma americana - AsaLady	D31
Hylin	Leve per radici	D45
	Strumenti per modellare amalgama/cera	K14
Hylin-Le Cron	Strumenti per modellare amalgama/cera	K14
Indiana University	Curettes e Scalers	G5
Iris	Forbicine per gengive	C4, C5
Ivory	Pinze per forare la diga	F8
	Pinze per uncini	F9
	Pinze per uncini - AsaLady	F10
Iwanson	Calibri	F42, K30
Jacquette	Curettes e Scalers	G9
	Scalers	G15
Jameson	Calibri	K30
Jarabak	Pinze per piegare fili	H27
Johnson	Pinze per piegare fili	H20
Jones	Pinze per pannilino	C31
Kelly	Forbicine per gengive	C5, E4
	Pinze emostatiche	C23, F44
Kilner	Divaricatori	C35
Kirkland	Bisturi per gengivectomia	G24
Klein	Pinze per estrazione per bambini	D39
Kocher	Pinze emostatiche	C20
	Divaricatori	C36
König	Scollaperiostio ed Elevatori	E25, G18
Kopp	Leve per radici	D50
La Grange	Forbicine per gengive	C7
Ladmore	Otturatori - Brunitori	F31
Langenbeck	Divaricatori	C36
Langer	Curettes e Scalers	G5
Lecluse	Leve per radici	D63

nome scientifico	categoria di strumento	pagina
Le Cron	Strumenti per modellare amalgama/cera	K15
Lessmann	Coltelli per cera	K22
Lichtenberg	Porta aghi	C15, E5
Locklin	Forbicine per gengive	C6
London College	Pinzette per medicazioni	B4
	Pinzette per medicazioni - AsaLady	B5
London Hospital	Leve per radici	D46
Lucas	Cucchiai alveolari	G20
Luer	Pinze ossivore alveolotome	D42, E30
Luks	Otturatori per canali	B13
Luniatshchek	Strumenti per legature	H36
	Porta-tamponi	F39
Mac Millan	Leve per radici	D56
Machtou	Otturatori per canali	B13
Markley	Otturatori per amalgama	F29
Marquette	Otturatori per amalgama	F28
Mathieu	Porta aghi	C16, C17, E5
Mayo	Forbicine per gengive	C8
Mayo-Hegar	Porta aghi	C12
	Porta aghi - AsaLady	C12
Mc Call	Curettes e Scalers	G7
Mc Kellops	Pinze per piegare fili	H18
Mead	Pinze per estrazione	D24
	Pinze ossivore alveolotome	D43
	Martelli chirurgici	E16, G29
	Scollaperiostio ed Elevatori	E24, G17
Meriam	Pinzette per medicazioni	B4
	Pinzette per medicazioni - AsaLady	B5
	Pinzette per laboratorio	K19
Merrit	Sonde millimetriche parodontali	G3
Mershon	Spingibande	H34
Metzenbaum	Forbicine per gengive	C8
Metzenbaum-Delikat	Forbicine per gengive	C8, E4
Micro-Adson	Pinzette chirurgiche	C38, C39
Micro-Barraquer	Porta aghi	C17, E6
Micro-Mosquito	Pinze emostatiche	C22, F44
Middeldorpf	Divaricatori	C37, E12
Miller	Lime	E21, G23
	Pinzette per carta da articolazione	F42
Miller-Apexo	Leve per radici	D52, D60
Mini-Crane-Kaplan	Curettes e Scalers	G8
Mini-Friedman	Pinze ossivore alveolotome	D42, E30
	Pinze ossivore alveolotome	G30
	Leve per radici	D57

nome scientifico	categoria di strumento	pagina
Mini-Ruskin	Pinze ossivore alveolotome	D44
Mini Ryder	Porta aghi	C13
Molt	Apribocca	C33
	Scollaperiostio ed Elevatori	E23, G16
Nabers	Sonde doppie	B11
Nance	Pinze per piegare fili	H11, H12, H15
Neumann	Forbicine per gengive	C7
Nevius	Pinze per estrazione forma americana	D27
	Pinze per estrazione forma americana - AsaLady	D31
New York University	Otturatori - Brunitori	F31
Novatech	Sonde millimetriche parodontali	G3
Noyes (Castroviejo)	Forbicine per gengive	C7
Ochsenbein	Scalpellini e sgorbie per parodontologia	G27
	Scalpellini chirurgici	G26
Ogden-Felsch	Pinze per estrazione	D19
Olsen-Hegar	Porta aghi	C10
Orban	Strumenti per applicazione di tinture e medicinali	F39
	Bisturi per gengivectomia	G25
Orringer	Divaricatori per labbra	E11
	Divaricatori - abbassalingua	C34
Partsch	Scalpellini e sgorbie per parodontologia	G28
	Martelli chirurgici	E16, G29
	Scollaperiostio ed Elevatori	E24, G17
Pean	Pinze emostatiche	C20
Perry	Pinzette per medicazioni	B4
Physick	Pinze per estrazione forma americana	D25
	Pinze per estrazione forma americana - AsaLady	D29
P.K. Thomas	Strumenti per modellare amalgama/cera	K17
Polokoff	Lime	G23
Pott	Leve per radici	D63
Prichard	Scollaperiostio ed Elevatori	E23, G16
Quinby	Forbicine per gengive	C5
Reynolds	Pinze per piegare fili	H16
Rhein	Sonde singole	B6
Rhodes	Scalpellini chirurgici	G26
Roach	Strumenti per modellare amalgama/cera	K16

nome scientifico	categoria di strumento	pagina
Roser-Koenig	Apribocca	C33
Routurier	Pinze per estrazione	D6, D7, D16
Rule	Curettes e Scalers	G5
Sanders	Bisturi per gengivectomia	G25
Schaedle	Pinze per pannolino	C31
Schilder	Otturatori per canali	B14
Schluger	Lime	G22
Schmeckebier-Apexo	Leve per radici	D49, D59
Schwarz	Pinze per piegare fili	H25
Seldin	Leve per radici	D52, D53, D54, D60
	Scollaperiostio ed Elevatori	E25, G18
Semken-Taylor	Pinzette chirurgiche	C41, E36
Senn-Miller	Divaricatori	C35
Schaedle	Pinze per pannolino	C31
Spencer	Forbicine per gengive	C8
SS. White	Escavatori	F16
Sternberg	Divaricatori	E11
	Abbassalingua	C34
Stevens	Forbicine per gengive	C9
Stieglitz	Pinze e pinzette per coni d'argento	B16
	Pinze per radici e frammenti	D41
Stoke	Pinze per uncini	F9
Stout	Leve per radici	D53
Sugarman	Lime	G22
Sullivan	Forbicine per gengive	C6
Tanner	Otturatori per amalgama	F28
Taylor	Curettes e Scalers	G8
Toennis	Porta aghi	C14
Tofflemire	Porta matrici	F46
	Matrici	F47
Tomati	Ulocistotomi	G30
Tomes	Pinze per estrazione forma americana	D27
	Pinze per estrazione forma americana - AsaLady	D31
Towner	Scalers	G14
Towner	Scalers	G14
Townley	Calibri	K30
Trotter	Pinze per estrazione	D17, D19, D20
Tweed	Pinze per piegare fili	H12, H13, H14, H15
University of Michigan	Combinazioni sonde - Sonde millimetriche	B10
	Sonde millimetriche parodontali	G3
University of Minnesota	Divaricatori	E12
	Abbassalingua	C34

nome scientifico	categoria di strumento	pagina
USC Towner (University of South California)	Strumenti per modellare e rifinire otturazioni	F37
	Bisturi per gengivectomia	G25
	Strumenti per modellare amalgama/cera	K13
Vickers	Martelli chirurgici	G29
Vehe	Strumenti per modellare amalgama/cera	K16
Wahl	Lime	G23
Wakefield	Scalpellini e sgorbie per parodontologia	G27
Walter F. Barry	Leve per radici	D61
Waldsachs	Pinze per piegare fili	H11
Ward	Otturatori per amalgama	F28
	Strumenti per modellare e rifinire otturazioni	F36
	Strumenti per modellare amalgama/cera	K13
Warwick-James	Mini leve per frammenti di radici	D64
Wedelstaet	Strumenti da smalto - preparazione cavità	F18
Weingart	Pinze ausiliarie	H29
Westcott	Otturatori per amalgama	F25
	Otturatori - Brunitori	F31
	Forbicine per gengive	C7
White	Pinze per estrazione	D17
Wiland	Strumenti per modellare e rifinire otturazioni	F37
Williams	Combinazioni sonde - Sonde millimetriche	B10, B11
	Sonde millimetriche parodontali	G3
Williger	Cucchiai alveolari	G21
	Scollaperiostio ed Elevatori	E25, G19
	Divaricatori	C35
Winter	Leve per radici	D62
Witzel	Pinze per radici e frammenti	D40
Woodson	Strumenti per otturazioni plastiche	F35
Woodward	Leve per radici	D56
Young	Pinze tiralingua	C33
	Pinze per piegare fili	H14
Younger-Good	Curettes e Scalers	G8
Zahle	Strumenti per modellare amalgama/cera	K15, K16
Zerfing-Chisel	Curettes e Scalers	G4



MONOUSO ASAONE

MADE IN ITALY

NUMERI UNO NEL MONOUSO DI QUALITÀ

Asa Dental ha sfruttato la propria esperienza progettuale e produttiva, che ha reso le proprie cannule aspirasaliva le più vendute al mondo, estendendola a un'intera famiglia di prodotti. Il risultato è AsaOne, la linea monouso pensata per la sicurezza e il comfort dei professionisti del settore dentale e dei loro pazienti.

Materiali sicuri, uniti ad un design innovativo, sposano forma e colore per rendere qualsiasi studio dentale uno spazio accogliente dove ottenere i risultati migliori.



- A2 Cannule aspirasaliva
- A6 Salviette
- A8 Dappen dishes
- A10 Vassoi in plastica
- A12 Rulli di cotone
- A13 Rotoli per sterilizzare
- A14 Mascherine chirurgiche
- A15 Guanti per esame
- A18 Buste per sterilizzare
- A19 Mantelline
- A20 Accessori

Cannule al profumo di menta - AsaFresh



Cannule con cappuccio morbido - Total-Comfort

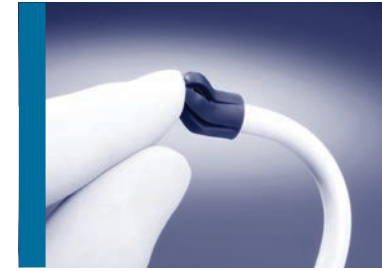

PUNTA NON SALDATA
100 pz / sacchetto
10 sacchetti / cartone
1000 pz

2908E-AT13/15
tubo blu
punta trasparente
2908E-TT13/T15
tubo trasparente
punta trasparente
2908E-VT13/15
tubo verde
punta trasparente



150 mm
2908E-AT15
130 mm
2908E-AT13

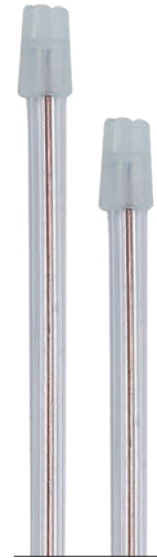

150 mm
2908E-TT15
130 mm
2908E-TT13



150 mm
2908E-VT15
130 mm
2908E-VT13

PUNTA NON SALDATA
100 pz / sacchetto
10 sacchetti / cartone
1000 pz

2903E-BA155
tubo bianco
punta blu
2903E-BT155
tubo bianco
punta trasparente
2903E-TA155
tubo trasparente
punta blu
2903E-TT155
tubo trasparente
punta trasparente



155 mm
2903E-BA155



155 mm
2903E-BT155



155 mm
2903E-TA155



155 mm
2903E-TT155

PUNTA SALDATA
100 pz / sacchetto
10 sacchetti / cartone
1000 pz

2908E-BBS15
tubo bianco
punta trasparente
2908E-TCS15
tubo trasparente
punta celeste
2908E-TTS15
tubo trasparente
punta trasparente
2908E-VTS15
tubo verde
punta trasparente



150 mm
2908E-BBS15



150 mm
2908E-TCS15



150 mm
2908E-TTS15



150 mm
2908E-VTS15

PUNTA SALDATA
100 pz / sacchetto
10 sacchetti / cartone
1000 pz

2903E-BAS155
tubo bianco
punta blu
2903E-BTS155
tubo bianco
punta trasparente
2903E-TAS155
tubo trasparente
punta blu
2903E-TTS155
tubo trasparente
punta trasparente



155 mm
2903E-BAS155



155 mm
2903E-BTS155



155 mm
2903E-TAS155



155 mm
2903E-TTS155

Cannule multi-color



Cannule multi-color



PUNTA NON SALDATA
2900E
 100 pz / sacchetto
 10 sacchetti / cartone
 1000 pz

2900E-AT13/15
 tubo blu
 punta trasparente
2900E-TT13/15
 tubo trasparente
 punta trasparente
2900E-VT13/15
 tubo verde
 punta trasparente
2900E-BT13/15
 tubo bianco
 punta trasparente
2900E-GT13/15
 tubo giallo
 punta trasparente
2900E-LT13/15
 tubo lilla
 punta trasparente

PUNTA NON SALDATA
2901E
 250 pz / sacchetto
 20 sacchetti / cartone
 5000 pz

2901E-AT13/15
 tubo blu
 punta trasparente
2901E-TT13/T15
 tubo trasparente
 punta trasparente
2901E-VT13/15
 tubo verde
 punta trasparente



150 mm
 2900E-AT15
 2901E-AT15
130 mm
 2900E-AT13
 2901E-AT13

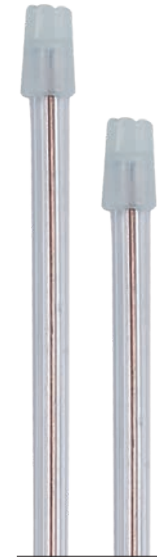

150 mm
 2900E-TT15
 2901E-TT15
130 mm
 2900E-TT13
 2901E-TT13



150 mm
 2900E-VT15
 2901E-VT15
130 mm
 2900E-VT13
 2901E-VT13

PUNTA NON SALDATA
 100 pz / sacchetto
 10 sacchetti / cartone
 1000 pz

2900E-OT13/15
 tubo arancio
 punta trasparente
2900E-RT13/15
 tubo rosso
 punta trasparente
2900E-ZT13/15
 tubo ciano
 punta trasparente



150 mm
 2900E-OT15
130 mm
 2900E-OT13



150 mm
 2900E-RT15
130 mm
 2900E-RT13



150 mm
 2900E-ZT15
130 mm
 2900E-ZT13

PUNTA SALDATA
 100 pz / sacchetto
 10 sacchetti / cartone
 1000 pz

2900E-ATS15
 tubo blu
 punta trasparente
2900E-BBS15
 tubo bianco
 punta trasparente
2900E-TCS15
 tubo trasparente
 punta celeste
2900E-TTS15
 tubo trasparente
 punta trasparente
2900E-VTS15
 tubo verde
 punta trasparente



150 mm
 2900E-ATS15



150 mm
 2900E-BBS15



150 mm
 2900E-TCS15



150 mm
 2900E-TTS15



150 mm
 2900E-VTS15

Salviette - AsaRainbow



Salviette - AsaRainbow



Lilla
3510-L
3511-L



Lime
3510-LI
3511-LI

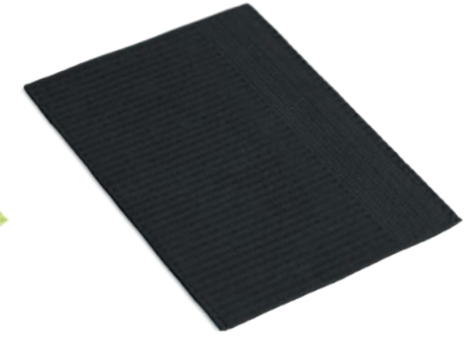

Nero
3510-N
3511-N

33x45 cm
tre veli

3510
cartone da 500 pz

3511
disponibile su richiesta
50 pz / busta
10 buste / cartone
500 pz



Bianco
3510-B
3511-B

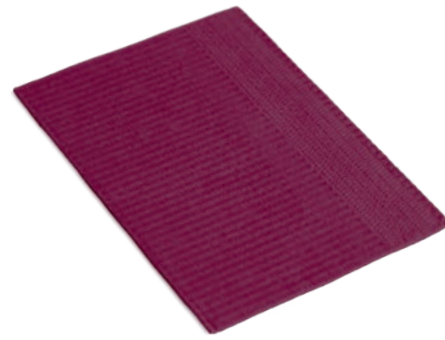

Bordeaux
3510-BX
3511-BX



Arancio
3510-O
3511-O



Rosa
3510-P
3511-P



Pesca
3510-PE
3511-PE

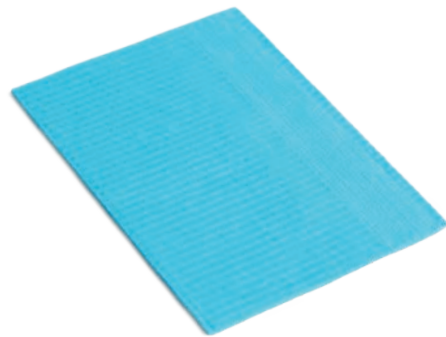

Celeste
3510-C
3511-C

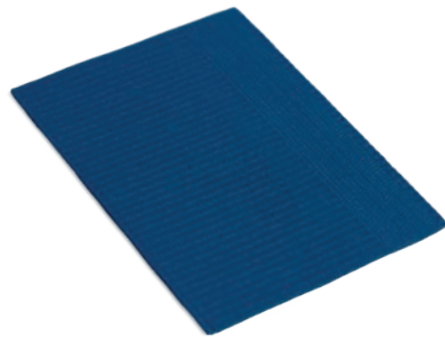

Blu scuro
3510-D
3511-D



Giallo
3510-G
3511-G

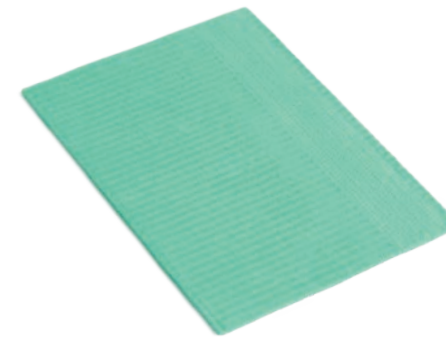

Verde
3510-V
3511-V



3200
catenella reggi salviette

Dappen dishes



50 pz / sacchetto
5 sacchetti per colore / cartone
1000 pz



Giallo + Rosso + Bianco + Blu
3700-MX

Dappen dishes

50 pz / sacchetto
20 sacchetti per colore / cartone
1000 pz



Nero
3700-N



Giallo
3700-G



Blu
3700-C



Bianco
3700-B



Rosso
3700-R

Vassoi in plastica

281x183x17 mm



Bianco liscio
AL2727-1



Bianco zigrinato
AL2727-1Z

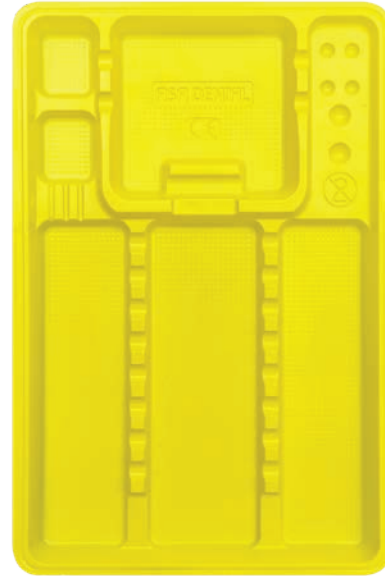

Giallo zigrinato
AL2727-1GZ



Blu zigrinato
AL2727-1AZ



Verde ottanio zigrinato
AL2727-1CZ

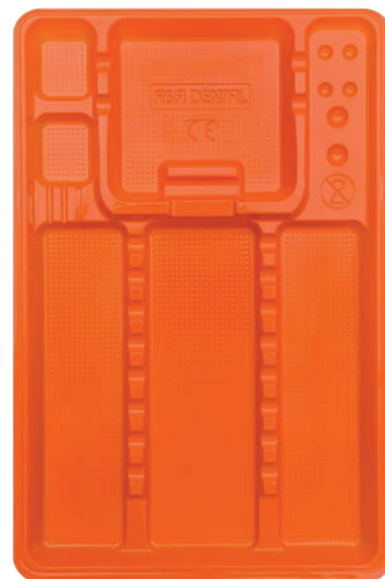

Arancio zigrinato
AL2727-1OZ

Vassoi in plastica

183x140x17 mm

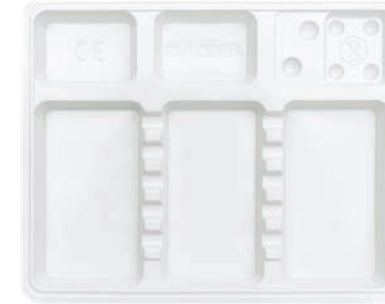

Bianco liscio
AL2727-2

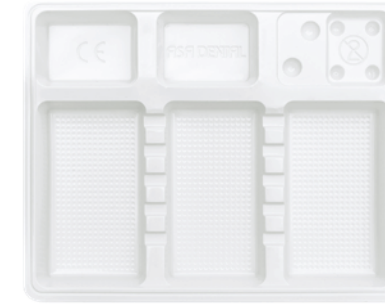

Bianco zigrinato
AL2727-2Z

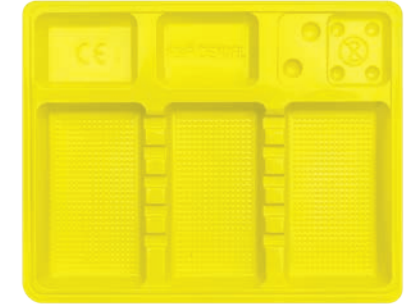

Giallo zigrinato
AL2727-2GZ



Blu zigrinato
AL2727-2AZ



Verde ottanio zigrinato
AL2727-2CZ



Arancio zigrinato
AL2727-2OZ

200x150 mm
400 pz / confezione



Bianco liscio
AL2738-1

Bianco liscio
AL2738-2

200x100 mm
400 pz / confezione

Rulli di cotone

100% cotone
300 gr. / sacchetto
20 sacchetti / cartone

16800 pz / cartone

Ø 8 mm | 840 pz
3520-1



12000 pz / cartone

Ø 10 mm | 600 pz
3520-2



9000 pz / cartone

Ø 12 mm | 450 pz
3520-3



Rotoli per sterilizzare

carta a elevata grammatura e film di polipropilene
con indicatore di avvenuto processo di sterilizzazione

8 pz / cartone

50 mm x 200 mt
3400E-55

75 mm x 200 mt
3400E-75

4 pz / cartone

100 mm x 200 mt
3400E-100

150 mm x 200 mt
3400E-150

2 pz / cartone

200 mm x 200 mt
3400E-200

250 mm x 200 mt
3400E-250

1 pz / cartone

300 mm x 200 mt
3400-300



Mascherine chirurgiche

materiali di alta qualità
in TNT
ipoallergeniche
prive di fibre di vetro
livello di B.F.E. 99,7%
50 pz / scatola
6 scatole / cartone
300 pz

mascherine con elastici

Bianco
3450E-B

Celeste
3450E-C

Rosa
3450E-R

Verde
3450E-V



Happy Kid
mascherine con elastici

Blu
3450E-HC

Rosa
3450E-HR



Guanti per esame

lattice
ambidestri
non sterili
100 guanti / scatola
10 scatole / cartone
1000 pz

privi di polvere e di amido
ipoallergenici

Extra small (5-6)
3301E-XS

Small (6-7)
3301E-S

Medium (7-8)
3301E-M

Large (8-9)
3301E-L



a basso contenuto di polvere

Extra small (5-6)
3303E-XS

Small (6-7)
3303E-S

Medium (7-8)
3303E-M

Large (8-9)
3303E-L



zigrinati
con polvere
verdi

Extra small (5-6)
3305-XS

Small (6-7)
3305-S

Medium (7-8)
3305-M

Large (8-9)
3305-L



Guanti per esame

in nitrile
 privi di polvere e di lattice
 zigrinati
 ambidestri
 non sterili
 240 mm
 AQL 1,5
 100 guanti / scatola
 10 scatole / cartone
 1000 pz

Blu

Extra small (5-6)
 3309E-XS

Small (6-7)
 3309E-S

Medium (7-8)
 3309E-M

Large (8-9)
 3309E-L



Bianco

Extra small (5-6)
 3310E-XS

Small (6-7)
 3310E-S

Medium (7-8)
 3310E-M

Large (8-9)
 3310E-L



Guanti per esame

Lilla

Extra small (5-6)
 3313E-XS

Small (6-7)
 3313E-S

Medium (7-8)
 3313E-M

Large (8-9)
 3313E-L



Violetto

Extra small (5-6)
 3314E-XS

Small (6-7)
 3314E-S

Medium (7-8)
 3314E-M

Large (8-9)
 3314E-L



Verde

Extra small (5-6)
 3311E-XS

Small (6-7)
 3311E-S

Medium (7-8)
 3311E-M

Large (8-9)
 3311E-L



Celeste

Extra small (5-6)
 3312E-XS

Small (6-7)
 3312E-S

Medium (7-8)
 3312E-M

Large (8-9)
 3312E-L



Rosa

Extra small (5-6)
 3315E-XS

Small (6-7)
 3315E-S

Medium (7-8)
 3315E-M

Large (8-9)
 3315E-L



Nero

Extra small (5-6)
 3316E-XS

Small (6-7)
 3316E-S

Medium (7-8)
 3316E-M

Large (8-9)
 3316E-L



Buste per sterilizzare

buste autosigillanti

200 pz / scatola
12 scatole / cartone
2400 pcs



75x250 mm
3403-75



90x230 mm
3403-90

200 pz / scatola
8 scatole / cartone
1600 pz



140x250 mm
3403-140

Mantelline

rotoli a strappo
impermeabili
due strati di polietilene e carta

3251E
53x60 cm
80 strappi
9 rotoli / cartone

3252E
53x80 cm
60 strappi
9 rotoli / cartone



Bianco
3251E-B/9
3252E-B/9



Celeste
3251E-C/9
3252E-C/9



Blu scuro
3251E-D/9
3252E-D/9



Giallo
3251E-G/9
3252E-G/9



Lilla
3251E-L/9
3252E-L/9



Lime
3251E-LI/9
3252E-LI/9



Arancio
3251E-O/9
3252E-O/9



Verde
3251E-V/9
3252E-V/9

Bicchieri



200 cc
100 pz / confezione
30 confezioni / cartone
3000 pz



Bianco
3818-B

Spatole per miscelazione

100 pz / confezione



AL2736

Pozzetti per miscelazione

70x54x6 mm
12 cavità
1000 pz / confezione



AL2735

Distributori per bicchieri

85 x 85 x 360 mm
per max 70 bicchieri



Argento
2750-1



Bianco
2750-2

Siringhe in plastica

per elastomeri
50 pz / scatola
10 scatole / cartone
500 pz



3710

Porta aghi usati

contenitore in plastica



AL2766

Kit strumenti prima visita

non sterili
contenuto:
2100-M
0700-M
0601-M



S0600-M

Portarifiuti

1000 pz / confezione



AL2767-1

supporto in alluminio
per portarifiuti



AL2767-2

Ghiaccio sintetico

14x18 cm
sacchetto in TNT
temperatura -4°C
25 sacchetti / cartone



3600E

Portaimpronta monouso in plastica

24 pz / confezione

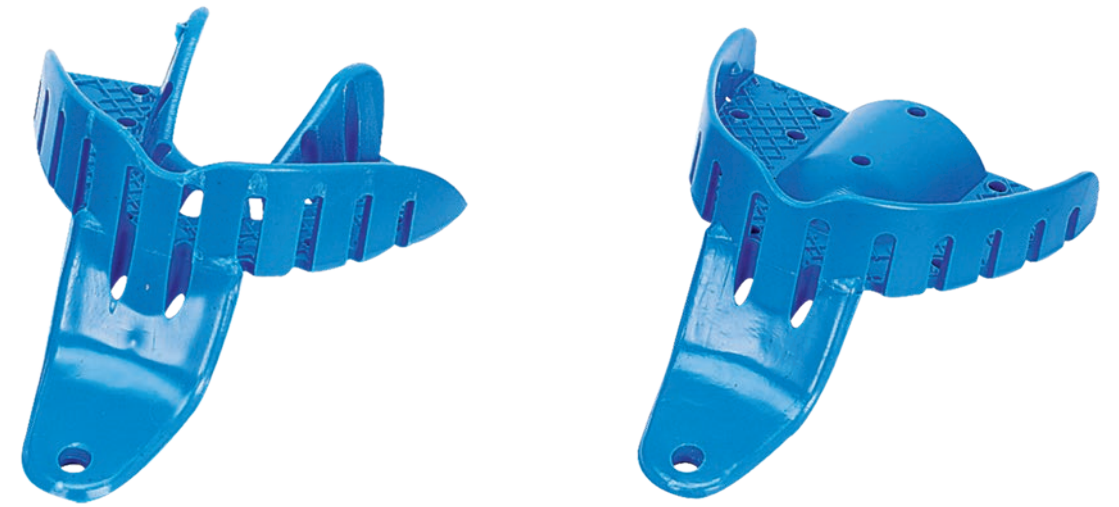

12 inferiori + 12 superiori



1
2853E-1

2
2853E-2



3
2853E-3

4
2853E-4

12 parziali destri + 12 parziali sinistri



1
2853E-1DS

2
2853E-2DS

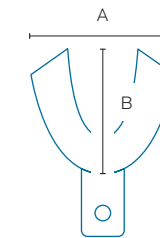

Inferiori	A (mm)	B (mm)
1	61	50
2	67	52
3	72	56
4	74	58

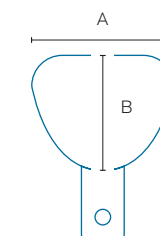

Superiori	A (mm)	B (mm)
1	61	49
2	65	53
3	70	59
4	73	63

DIAGNOSTICA

MADE IN ITALY

LA NOSTRA GAMMA DI STRUMENTI PER UNA DIAGNOSI COMPLETA ED EFFICIENTE

Uno degli obiettivi principali nella cura dentale è quello di favorire nel tempo la salute orale del paziente. Tutto ciò è possibile grazie ad una diagnosi affidabile, che permetta di comunicare in modo chiaro ed efficace con il paziente.

Per questa ragione abbiamo progettato strumenti diagnostici utilizzando materiali e forme che offrono il compromesso ideale tra precisione, elasticità, resistenza ed ergonomia, enfatizzando ciascuna caratteristica in base allo scopo dello strumento.

- B3 Pinzette per marcare le tasche
- B3 Pinzette per medicazioni
- B5 Sonde
- B10 Combinazioni sonde - Sonde millimetriche
- B12 Condensatori
- B13 Pluggers
- B15 Condensatori
- B15 Escavatori
- B16 Strumenti endodontici
- B17 Specchietti
- B21 Divaricatori ultralight
- B22 Kit

Manici

PUNTA SINGOLA



PUNTA DOPPIA

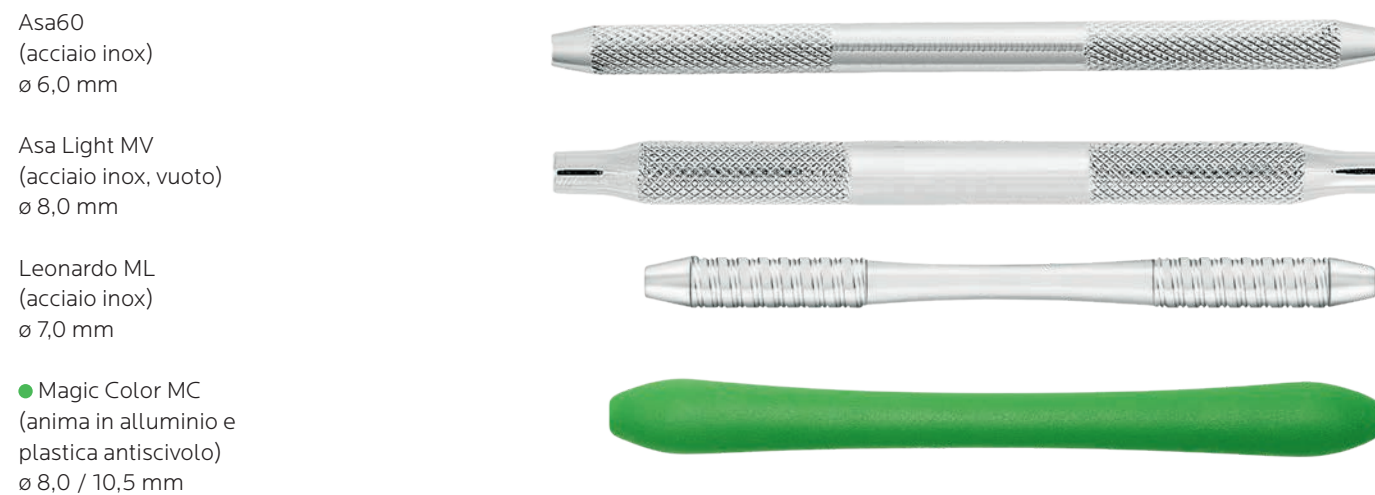

Come usare le informazioni

- 3R Rhein → modello + nome scientifico
- 0700-3R → codice Asa Dental
- Asa60 → manico

AsaLady

- prodotti ergonomici progettati su misura per le mani femminili:
- manici ridotti e più leggeri
 - anelli delle dita più piccoli
 - dimensioni ridotte
 - codici con prefissi "W" o "SW"

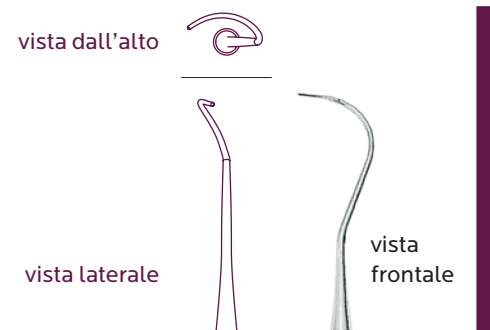
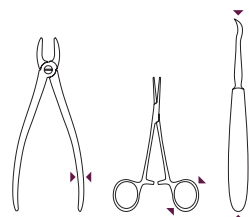

Pinzette per marcare le tasche



**1 (Crane-Kaplan)
Goldman-Fox
15 cm
0650-1**

**2 (Crane-Kaplan)
Goldman-Fox
15 cm
0650-2**

**Pinzette per medicazioni
con bloccaggio**



**18L Locking
16 cm
0600-18L**

**1
15 cm
0602-1**

**2
15 cm
0602-2**

Pinzette per medicazioni

set da 5



1 Flag
S0601-1



2 London-College
S0601-2



3 Meriam
S0601-3

Pinzette per medicazioni



0600-2

Antimagnetiche e facili da pulire, le pinzette Asa Dental sono sufficientemente leggere da garantire il comfort operativo necessario e tuttavia resistenti da permetterne un uso efficace nel tempo.

Le diverse forme delle punte e le varie inclinazioni permettono l'utilizzo in qualsiasi situazione. La coda presenta un rivestimento antiaderente ai materiali da otturazione, rendendola un versatile strumento per il loro posizionamento all'interno della cavità.



1 Flag 15 cm 0601-1	2 London-College 15 cm 0601-2	3 Meriam 16 cm 0601-3	4 Perry 13 cm 0601-4	5 Perry 13 cm 0601-5	4 Perry 13 cm 0600-4	2 London-College 16 cm 0600-2	3 16 cm 0600-3	17 16 cm 0600-17	18 16 cm 0600-18	19 16,5 cm 0600-19	1 Flag 14 cm W0610-1	2 London College 14 cm W0610-2	3 Meriam 15 cm W0610-3
---------------------------	-------------------------------------	-----------------------------	----------------------------	----------------------------	----------------------------	-------------------------------------	----------------------	------------------------	------------------------	--------------------------	----------------------------	--------------------------------------	------------------------------

Sonde singole



2
0700-2
Asa60
0701-2
Asa60M



3
0700-3
Asa60
0701-3
Asa60M



3A
0700-3A
Asa60
0701-3A
Asa60M



3R Rhein
0700-3R
Asa60
ML0700-3R
Leonardo ML



5
0700-5
Asa60
0701-5
Asa60M



6
0700-6
Asa60
0701-6
Asa60M
ML0700-6
Leonardo ML
MC0700-6
● Magic Color MC



8
0700-8
Asa60
0701-8
Asa60M
ML0700-8
Leonardo ML



9
0700-9
Asa60
0701-9
Asa60M
ML0700-9
Leonardo ML
MC0700-9
● Magic Color MC



10
0700-10
Asa60
0701-10
Asa60M



11
0700-11
Asa60
0701-11
Asa60M



12
0700-12
Asa60
0701-12
Asa60M



16
0700-16
Asa60
0701-16
Asa60M



17
0700-17
Asa60
0701-17
Asa60M
ML0700-17
Leonardo ML



17A
0700-17A
Asa60
0701-17A
Asa60M



23
0700-23
Asa60
0701-23
Asa60M
ML0700-23
Leonardo ML
MC0700-23
● Magic Color MC

Sonde singole



0700-23
Sonde ben affilate e acuminate, perfette per individuare anche le carie più piccole, offrono il bilanciamento ideale fra elasticità e rigidità. Grazie alla punta sottile e alla flessibilità controllata, sono estremamente utili per la rilevazione di fessure, per il sovradimensionamento nelle otturazioni e per la verifica della corretta chiusura marginale nelle riabilitazioni protesiche fisse.

set da 5
Asa60



6
S0700-6



9
S0700-9



11
S0700-11

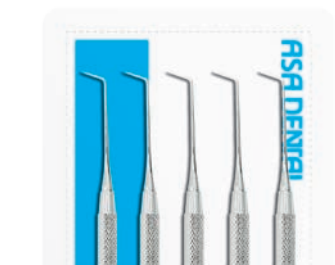

16
S0700-16



23
S0700-23

Sonde doppie



6/9
0704-6D9
Asa60
ML0704-6D9
Leonardo ML
MC0704-6D9
● Magic Color MC

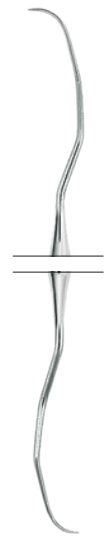

11/12AF
0704-11/12AF
Asa60
ML0704-11/12AF
Leonardo ML
MC0704-11/12AF
● Magic Color MC

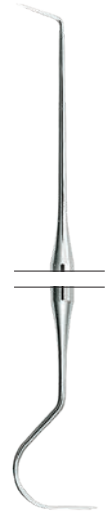

16/23
0704-16D1
Asa60
MV0704-16D1
Asa Light MV

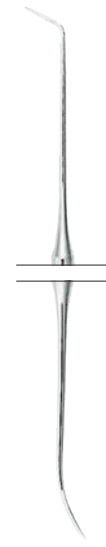

16/3
0704-16D2
Asa60
MV0704-16D2
Asa Light MV

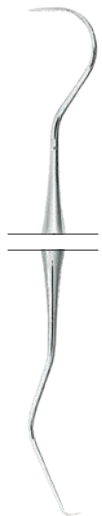

23/17
0704-23D1
Asa60
MV0704-23D1
Asa Light MV
ML0704-23D1
Leonardo ML
MC0704-23D1
● Magic Color MC

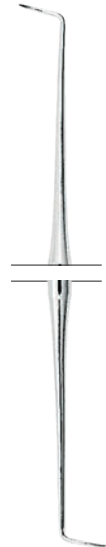

3
0709-3
Asa60
MV0709-3
Asa Light MV

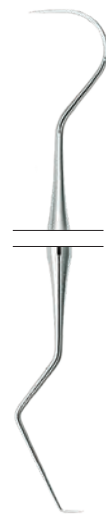

23/17A
0704-23D2
Asa60
MV0704-23D2
Asa Light MV

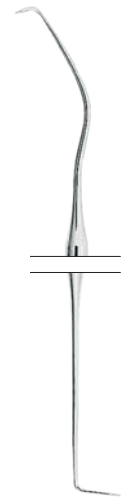

UT 1/2 Cattoni
0704-UT1
Asa60
MV0704-UT1
Asa Light MV

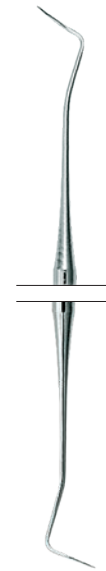

2
0709-2
Asa60
MV0709-2
Asa Light MV

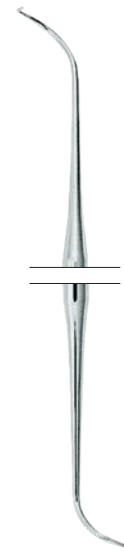

2A
0709-2A
Asa60
MV0709-2A
Asa Light MV

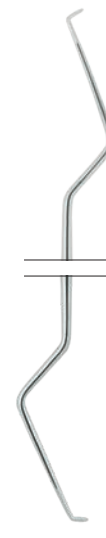

17/19
ML0704-6D2
Leonardo ML

Sonde doppie

Sonde per canali



6/1
0710-6D1
Asa60
MV0710-6D1
Asa Light MV

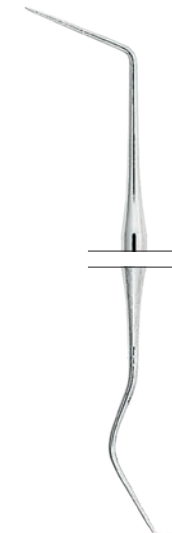



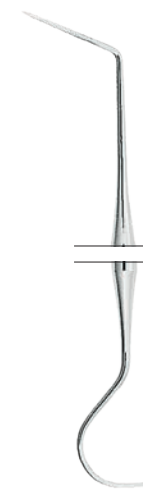

6/17
0710-6D2
Asa60
MV0710-6D2
Asa Light MV

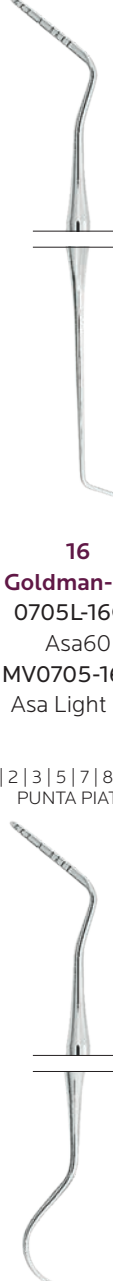
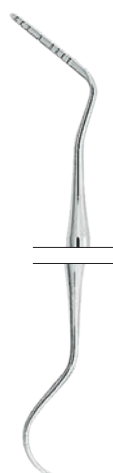
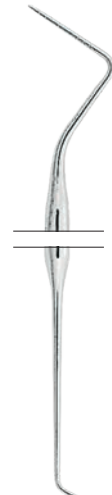
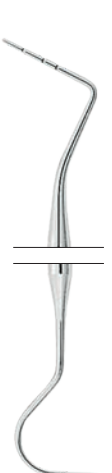
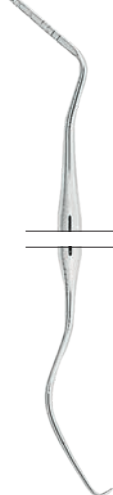
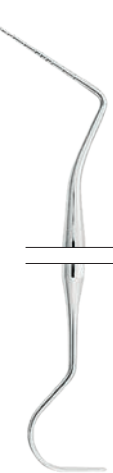
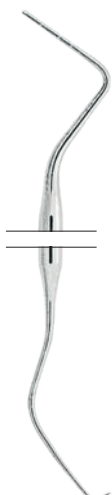

6/23
0710-6D3
Asa60
MV0710-6D3
Asa Light MV

Combinazioni sonde - Sonde millimetriche

<p>1 2 3 5 7 8 9 10 PUNTA PIATTA</p>  <p>3 Goldman-Fox 0705L-3GF Asa60 MV0705-3GF Asa Light MV</p>	<p>1 2 3 5 7 8 9 10 PUNTA PIATTA</p>  <p>16 Goldman-Fox 0705L-16GF Asa60 MV0705-16GF Asa Light MV</p> <p>1 2 3 5 7 8 9 10 PUNTA PIATTA</p>  <p>23 Goldman-Fox 0705L-23GF Asa60 MV0705-23GF Asa Light MV</p>	<p>1 2 3 5 7 8 9 10</p>  <p>16 Williams 0705L-16W Asa60 MV0705-16W Asa Light MV</p> <p>3 6 8</p>  <p>23 University of Michigan 0705L-23UM Asa60 MV0705-23UM Asa Light MV</p>	<p>1 2 3 5 7 8 9 10 PUNTA PIATTA</p>  <p>17 Goldman-Fox 0705L-17GF Asa60 MV0705-17GF Asa Light MV</p> <p>1 2 3 5 7 8 9 10</p>  <p>23 Williams 0705L-23W Asa60 MV0705-23W Asa Light MV ML0705-23W Leonardo ML</p>	<p>3 6 8</p>  <p>17 University of Michigan 0705L-17UM Asa60 MV0705-17UM Asa Light MV</p> <p>3 6 8 11</p>  <p>23/CP11 0706L-2311 Asa60 MV0706-2311 Asa Light MV</p>	<p>1 2 3 5 7 8 9 10</p>  <p>17 Williams 0705L-17W Asa60 MV0705-17W Asa Light MV</p> <p>3 6 9 12</p>  <p>23/CP12 0706L-2312 Asa60 MV0706-2312 Asa Light MV</p>
--	--	--	--	---	--

Sonde doppie

<p>1 2 3 5 7 8 9 10 PUNTA PIATTA</p>  <p>Goldman-Fox Williams 0707L-GFW Asa60 MV0707-GFW Asa Light MV MC0707-GFW ● Magic Color MC</p>	<p>3 6 9 12</p>  <p>2N Nabers 0708L-2N Asa60</p>	<p>1 2 3 5 7 8 9 10 PUNTA PIATTA</p>  <p>1N Nabers 0708-1N Asa60 MV0708-1N Asa Light MV</p>	<p>12 9 6 3</p>  <p>2N Nabers 0708-2N Asa60 MV0708-2N Asa Light MV ML0708-2N Leonardo ML MC0708-2N ● Magic Color MC</p>
--	--	---	---

MV0707L-GFW



Condensatori per trattamenti canalari



0800-1
STRUMENTI PER TRATTAMENTI CANALARI
Questi strumenti sono dotati di un rivestimento che consente alle punte di svolgere la loro funzione senza alcuna aderenza, qualunque sia la condizione operativa e la pressione applicata.

1
0800-1
Asa60
ML0800-1
Leonardo ML
MC0800-1
● Magic Color MC

2
0800-2
Asa60
ML0800-2
Leonardo ML
MC0800-2
● Magic Color MC

3
0800-3
Asa60
ML0800-3
Leonardo ML
MC0800-3
● Magic Color MC

4
0800-4
Asa60

5
0800-5
Asa60

6
0800-6
Asa60

7
0800-7
Asa60

Otturatori per canali

1 Luks
0801-1
Asa60

2 Luks
0801-2
Asa60

3 Luks
0801-3
Asa60

4 Luks
0801-4
Asa60

1 Machtou
ML0803-1
Leonardo ML
MC0803-1
● Magic Color MC

2 Machtou
ML0803-2
Leonardo ML
MC0803-2
● Magic Color MC

3 Machtou
ML0803-3
Leonardo ML
MC0803-3
● Magic Color MC

4 Machtou
ML0803-4
Leonardo ML
MC0803-4
● Magic Color MC

Otturatori per canali

Condensatori

Escavatori canalari

Ø 0,30
15 | 20

Ø 0,35
10 | 15 | 20

Ø 0,40
5 | 10 | 15 | 20

Ø 0,50
5 | 10 | 15 | 20

Ø 0,60
5 | 10 | 15 | 20

Ø 0,70
5 | 10 | 15 | 20

Ø 0,80
5 | 10 | 15 | 20

Ø 0,90
5 | 10 | 15 | 20

Ø 1,05
5 | 10 | 15 | 20

Ø 1,20
5 | 10 | 15 | 20

7 ½ Schilder
ML0802-1
Leonardo ML

8 Schilder
ML0802-2
Leonardo ML
MC0802-2
● Magic Color MC

8 ½ Schilder
ML0802-3
Leonardo ML

9 Schilder
ML0802-4
Leonardo ML
MC0802-4
● Magic Color MC

9 ½ Schilder
ML0802-5
Leonardo ML

10 Schilder
ML0802-6
Leonardo ML
MC0802-6
● Magic Color MC

10 ½ Schilder
ML0802-7
Leonardo ML

11 Schilder
ML0802-8
Leonardo ML

11 ½ Schilder
ML0802-9
Leonardo ML

10 Schilder
ML0802-10
Leonardo ML

Ø 0,5
5 | 10 | 15 | 20

Ø 0,7
5 | 10 | 15 | 20

Ø 0,9
5 | 10 | 15 | 20

Ø 1,1
5 | 10 | 15 | 20

Ø 1,2

Ø 1,5

Ø 2

1
0802L-1
Asa60

2
0802L-2
Asa60

3
0802L-3
Asa60

4
0802L-4
Asa60

PIASTRA MILLIMETRICA PER ENDODONZIA
0800

31L
1709-31L
Asa60
MV1709-31L
Asa Light MV

32L
1709-32L
Asa60
MV1709-32L
Asa Light MV

33L
1709-33L
Asa60
MV1709-33L
Asa Light MV

Strumenti endodontici

Pinze per togliere
tiranervi rotti



1
13 cm
0870-1



2
13 cm
0870-2

Pinze e pinzette
per coni d'argento



1 Stieglitz
0102-1



2 Stieglitz
0102-2

Specchietti per fotografie

Superfici occlusali

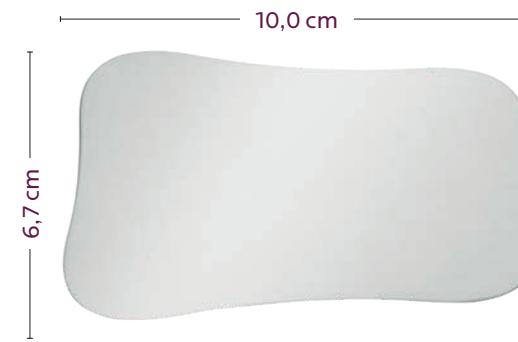

2250-1

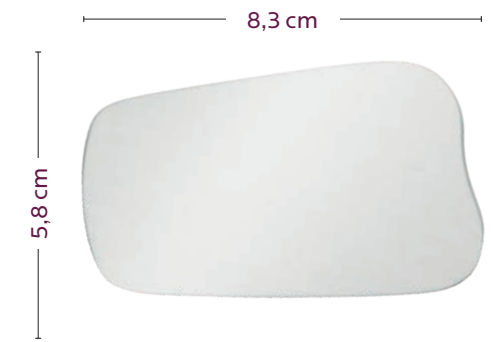

2250-2

Superfici vestibolari



2250-3

Superfici linguali

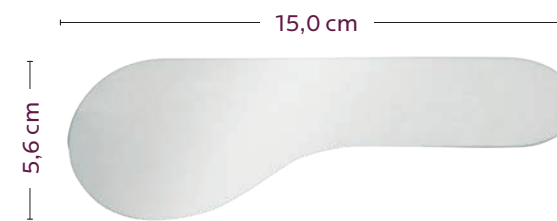

2250-4



2250-5

Specchietti per bocca

scatola da 12



4
Ø 22 mm
piano
2220E-4

4
Ø 22 mm
piano
2200E-4

5
Ø 24 mm
piano
2200E-5

6
Ø 26 mm
piano
2200E-6

scatola da 12



5
Ø 24 mm
piano
2220E-5

4
Ø 22 mm
concavo
2201E-4

5
Ø 24 mm
concavo
2201E-5

scatola da 12



5
Ø 22 mm
piano
2221-4



5
Ø 24 mm
piano
2221-5

scatola da 6



5
Ø 24 mm
piano
doppio lato
2230-5

Specchietti per bocca

singolo



paralleizzatore
2002-6
paralleizzatore + manico
S2002-6
Asa60

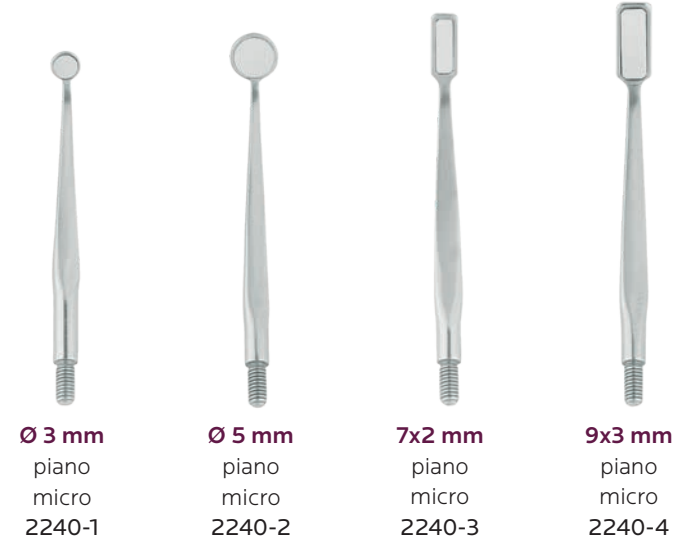

Ø 3 mm
piano
micro
2240-1

Ø 5 mm
piano
micro
2240-2

7x2 mm
piano
micro
2240-3

9x3 mm
piano
micro
2240-4

Manici



S2100
Ottagonale
set da 5

S2101
Asa60
set da 5

S2102-IN
Esagonale
vuoto
set da 5

ML2101
Leonardo ML

2104-B
Alu80

2104-C
Alu80

2104-G
Alu80

2104-R
Alu80

2104-V
Alu80

MC2101-B
Magic Color
MC

Specchietti per bocca - modello Americano

scatola da 12



4
Ø 22 mm
2210E-4
piano

5
Ø 24 mm
2210E-5
piano

4
Ø 22 mm
2211E-4
concavo

5
Ø 24 mm
2211E-5
concavo

scatola da 6



5
Ø 24 mm
piano
doppio lato
2231-5CS

Manici



2100-CS
Ottagonale

2101-CS
Asa60

2102-CS
Esagonale

Specchietti ultralight

dati tecnici:
lampadine Philips miniature
infrangibili da 2,25 V - 0,25 A
2 batterie alcaline tipo AAA da 1,5 V

ricambi:
0690-G guarnizione
0690-L luce
0690-M molla
0690-T testa



16 cm
0690



Divaricatori ultralight

dati tecnici:
lampadine Philips miniature
infrangibili da 2,25 V - 0,25 A
2 batterie alcaline tipo AAA da 1,5 V



15 cm
0691



come usare lo specchietto ultralight e il divaricatore ultralight:

- inserire 2 batterie alcaline
- togliere le batterie prima della sterilizzazione
- guarnizione interna sterilizzabile posta sulla lampadina che evita l'infiltrazione di saliva o liquidi in genere all'interno del manico preservando così l'integrità delle batterie
- facilità di accensione e spegnimento grazie al tappo posteriore dello strumento che funziona da pratico interruttore
- nessun tipo di manutenzione delle parti elettriche o meccaniche
- completamente smontabile per una corretta pulizia
- facilità nella sostituzione delle lampadine e delle batterie
- impugnatura ergonomica

Kit ultralight con specchietto e divaricatore in un locking tray mini

contenuto:
0690 specchietto ultralight
0691 divaricatore ultralight
2772-1 locking tray mini



S0690-2

Kit strumenti prima visita



S0600-6

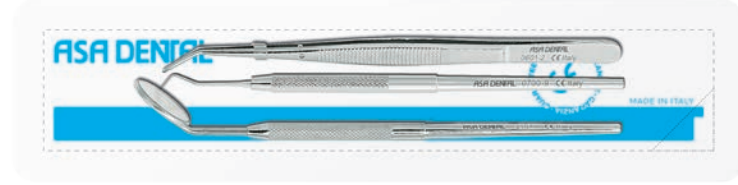

S0600-9

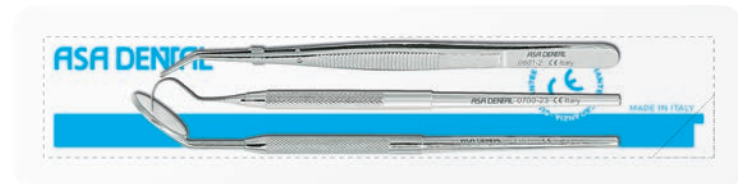

S0600-23

- contenuto:
- 6** sonda con manico anatomico 0700-6
 - 2** pinzetta per medicazioni London-College 0601-2
 - manico per specchietto anatomico 2101
 - 4** specchietto piano 2200-4

- contenuto:
- 9** sonda con manico anatomico 0700-9
 - 2** pinzetta per medicazioni London-College 0601-2
 - manico per specchietto anatomico 2101
 - 4** specchietto piano 2200-4

- contenuto:
- 23** sonda con manico anatomico 0700-23
 - 2** pinzetta per medicazioni London-College 0601-2
 - manico per specchietto anatomico 2101
 - 4** specchietto piano 2200-4

Kit strumenti prima visita - Magic Color



SMC0600-6



SMC0600-9



SMC0600-23

- contenuto:
- 6** sonda con manico Magic Color MC0700-6
 - 2** pinzetta per medicazioni London-College 0601-2
 - manico Magic Color per specchietto MC2101-B
 - 4** specchietto piano 2200-4

- contenuto:
- 9** sonda con manico Magic Color MC0700-9
 - 2** pinzetta per medicazioni London-College 0601-2
 - manico Magic Color per specchietto MC2101-B
 - 4** specchietto piano 2200-4

- contenuto:
- 23** sonda con manico Magic Color MC0700-23
 - 2** pinzetta per medicazioni London-College 0601-2
 - manico Magic Color per specchietto MC2101-B
 - 4** specchietto piano 2200-4

Kit strumenti prima visita - AsaLady

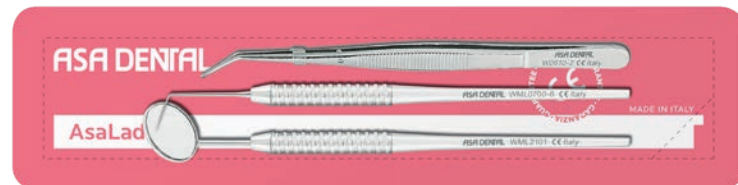

SWML0600-6

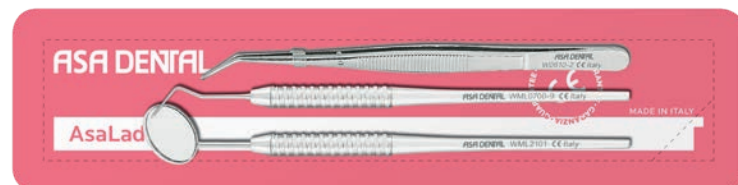

SWML0600-9

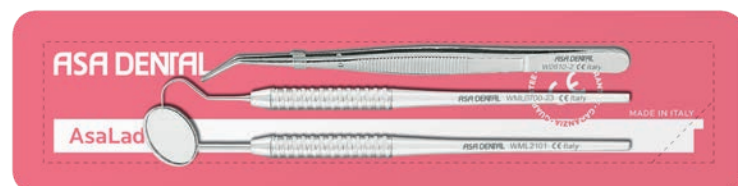

SWML0600-23

- contenuto:
- 6** sonda con manico anatomico WML0700-6
 - 2** pinzetta per medicazioni London-College WML0610-2
 - manico Leonardo per specchietto WML2101
 - 4** specchietto piano 2200-4

- contenuto:
- 9** sonda con manico anatomico WML0700-9
 - 2** pinzetta per medicazioni London-College WML0610-2
 - manico Leonardo per specchietto WML2101
 - 4** specchietto piano 2200-4

- contenuto:
- 23** sonda con manico anatomico WML0700-23
 - 2** pinzetta per medicazioni London-College WML0610-2
 - manico Leonardo per specchietto WML2101
 - 4** specchietto piano 2200-4



Kit di strumenti Magic Color

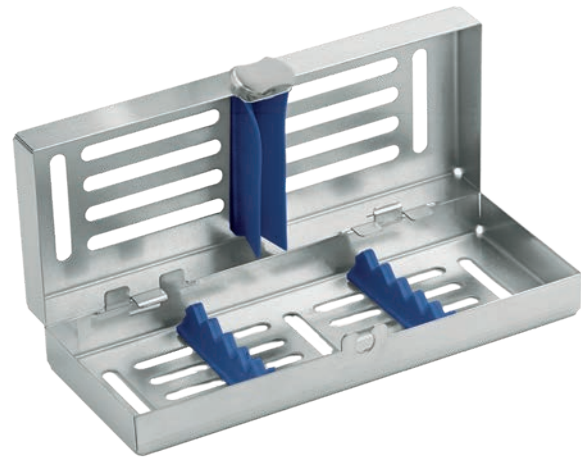

kit di strumenti diagnostici
SMC0700-5



	manico per specchio	MC2101-B
4	specchietto piano	2200-4
	sonda Williams	MC0703-14
23/17	sonda doppia	MC0704-23D1
2	escavatore	MC1700-2
2	pinzetta per medicazioni London-College	0601-2
	mini locking tray	2772-1

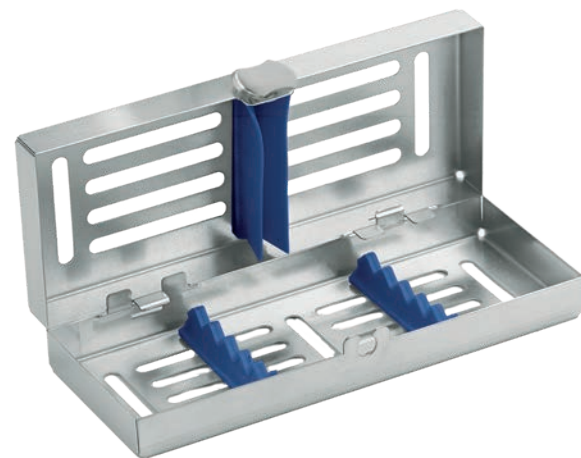

kit di strumenti endodontici
SMC0800-5



6/9	sonda doppia	MC0704-6D9
1	escavatore	MC1700-1
1	spreader/plugger	MC0803-1
1/2	Hollenback	MC1500-02
2	pinzetta per medicazioni London-College	0601-2
	mini locking tray	2772-1

Kit per endodonzia



set da 7 strumenti
(incisione laser)
S0702L-7



set da 23 strumenti
Boston university
S0702L-23



set per endodonzia
S0800

CP-12S	sonda millimetrica O.M.S. punta colorata (incisione laser)	0702L-12S
CP-12	sonda millimetrica punta colorata (incisione laser)	0702L-12
	sonda millimetrica Williams (incisione laser)	0703L-1
	sonda millimetrica Goldman-Fox (incisione laser)	0703L-4
23/CP-12	combinazione sonda/sonda millimetrica (incisione laser)	0706L-2312
1	condensatore (incisione laser)	0802L-1
2	condensatore (incisione laser)	0802L-2
	piastra millimetrica per endodonzia	0800
	vassoio forato completo di griglia	S2702

2	pinzetta per medicazioni London-College	0601-2
	manico per specchio anatomico	2101
4	specchietto piano	2200-4
	piastra millimetrica per endodonzia	0800
23/17	sonda doppia Asa Light	MV0704-23D1
6/1	sonda per canali Asa Light	MV0710-6D1
16	combinazione sonda/sonda millimetrica Asa Light Williams	MV0705-16W
3	combinazione sonda/sonda millimetrica Asa Light Goldman-Fox	MV0705-3GF
CP-12S	sonda millimetrica O.M.S. punta colorata (incisione laser)	0702L-12S
CP-12	sonda millimetrica punta colorata (incisione laser)	0702L-12
CP-11	sonda millimetrica punta colorata (incisione laser)	0702L-11
23/CP-12	combinazione sonda/sonda millimetrica (incisione laser)	0706L-2312
1	condensatore	0800-1
32L	escavatore canalare Asa Light	MV1709-32L
19	escavatore doppio Asa Light	MV1706-19
14	escavatore doppio Asa Light	MV1703-14
1	escavatore doppio Asa Light	MV1701-1
1/2	curette Gracey Asa Light	MV1807-02
3/4	curette Gracey Asa Light	MV1807-04
5/6	curette Gracey Asa Light	MV1807-06
7/8	curette Gracey Asa Light	MV1807-08
9/10	curette Gracey Asa Light	MV1807-10
11/12	curette Gracey Asa Light	MV1807-12
13/14	curette Gracey Asa Light	MV1807-14
2	vassoio forato completo di griglia	S2721-2

	Pulitore in alluminio anodizzato per strumenti canalari	AL2746-1
	Piastra millimetrata	0800
	Pinzetta per medicazione London-College	0601-2
	Manico per specchio tondo	2101
4	Specchietto piano	2200-4
6/1	Sonda per canali	0710-6D1
31L	Escavatore canalare	1709-31L
1	Spreader	0800-1
	Griglia portastrumenti per 7 strumenti in acciaio inox	2700-G
	Vassoio forato inox completo di griglia	S2702



CHIRURGIA ORALE

MADE IN ITALY

LA PRECISIONE CHIRURGICA: NECESSARIA E INDISPENSABILE

Ogni esperto del settore ha la consapevolezza che quanto più un intervento è invasivo, tanto maggiore è il bisogno di spiegarlo con chiarezza al paziente. La sicurezza del paziente, la sua rassicurazione e la gestione del caso clinico diventano elementi fondamentali quanto l'esecuzione della procedura stessa. Attraverso la combinazione delle proprie abilità settoriali e dei nostri strumenti di precisione, il professionista assicura al paziente i migliori risultati nel minor tempo possibile. A tal proposito, lavoriamo costantemente per soddisfare le richieste di specialisti che esigono strumenti affidabili, capaci di ridurre la complessità dell'intervento e di prevenire qualsiasi tipo di complicazione.

- C3 Forbicine
- C10 Porta aghi
- C20 Pinze emostatiche
- C24 Bisturi
- C28 Siringhe
- C31 Pinze per pannolino
- C32 Pinze porta tamponi
- C33 Apribocca
- C33 Pinze tiralingua
- C34 Divaricatori
- C37 Sonde seno mascellare
- C38 Pinzette chirurgiche
- C44 Cannule per aspirazione
- C45 Cucchiari alveolari
- C46 Kit

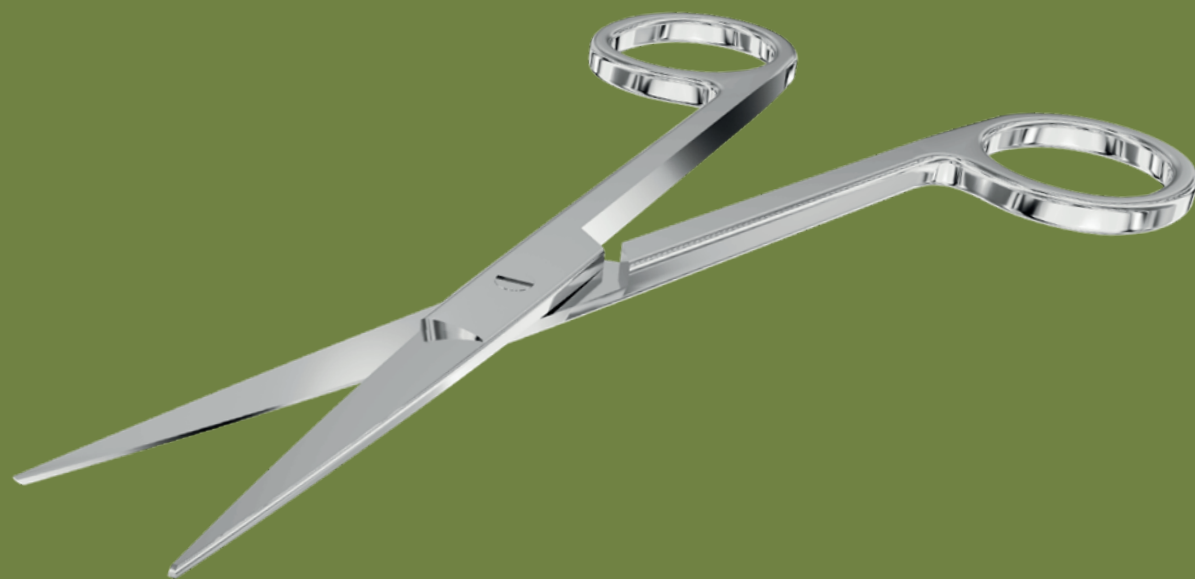

Manici

PUNTA SINGOLA

Asa60
(acciaio inox)
ø 6,0 mm

Asa Light MV
(acciaio inox, vuoto)
ø 8,0 mm

Leonardo ML
(acciaio inox)
ø 7,0 mm

● Magic Color MC
(anima in alluminio e
plastica antiscivolo)
ø 8,0 / 10,5 mm

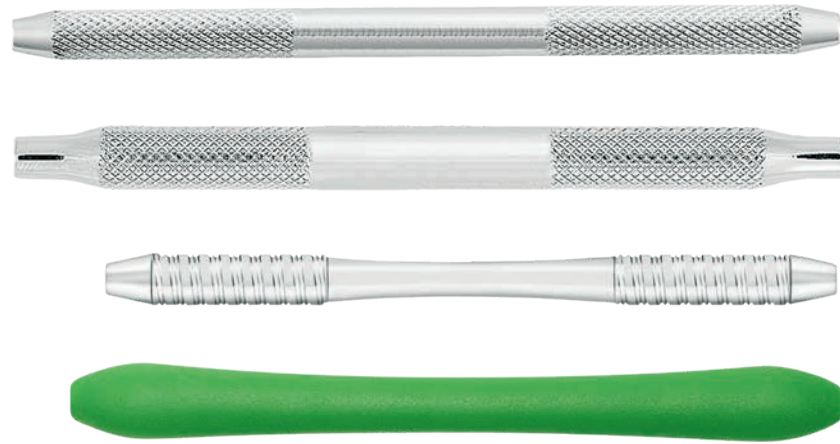

strumento standard



strumento con inserti al carburo di tungsteno (TC)

Come usare le informazioni

- 1 Hemingway → modello + nome scientifico
- MC2000-1 → codice Asa Dental
- Magic Color MC → manico

AsaLady

prodotti ergonomici progettati su misura per le mani femminili:

- manici ridotti e più leggeri
- anelli delle dita più piccoli
- dimensioni ridotte
- codici con prefissi "W" o "SW"

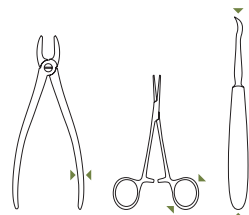

* questi prodotti non sono realizzati da Asa Dental e vengono commercializzati con il marchio del produttore

Forbicine per gengive



1
retta
12 cm
0300-1



2
curva
12 cm
0300-2



1
retta
12 cm
W0319-1



2
curva
12 cm
W0319-2



1
angolare
11,5 cm
0301-1



1
angolare
una punta dentata
11,5 cm
0301-2



1 Goldman-Fox
retta
una punta dentata
13 cm
0304-1



2 Goldman-Fox
curva
una punta dentata
13 cm
0304-2

Forbicine per gengive



1 Iris
retta
11,5 cm
0305-1



2 Iris
curva
11,5 cm
0305-2



1TC Iris
retta
11 cm
0305-1TC



2TC Iris
curva
11 cm
0305-2TC



3 Iris
curva
11,5 cm
0305-3



1 Quinby
retta
12,5 cm
0308-1



2 Quinby
curva
12,5 cm
0308-2



3 Goldman-Fox (special)
curva
una punta dentata
13 cm
0304-3



1TC Goldman-Fox
retta
13 cm
0304-1TC



2TC Goldman-Fox
curva
13 cm
0304-2TC



1TC Goldman-Fox
curva
17 cm
0306-1TC



1 Kelly
retta
16 cm
0309-1



2 Kelly
curva
16 cm
0309-2



1TC Kelly
retta
16 cm
0309-1TC



2TC Kelly
curva
16 cm
0309-2TC

Forbicine per gengive



1 Sullivan
retta
una punta dentata
14,5 cm
0311-1



2 Sullivan
curva
una punta dentata
14,5 cm
0311-2



1TC Locklin
angolare
16,5 cm
0310-1TC

Forbicine per gengive



1 Neumann
curva
12,5 cm
0302-1



1 Dean
curva
una punta dentata
17 cm
0306-1



1 La Grange
curva
una punta dentata
10,5 cm
0307-1



1 Locklin
angolare
una punta dentata
16,5 cm
0310-1



2 Locklin
angolare
una punta dentata
16,5 cm
0310-2



2TC Locklin
angolare
16,5 cm
0310-2TC



1 Noyes (Castroviejo)
curva
punte curve e sottili
12 cm
0303-1



1 Westcott
curva
punte acute
11 cm
0312-1



2 Westcott
curva
punte arrotondate
11 cm
0312-2



1
curva
punte curve e sottili
14,5 cm
0313-1

Forbicine per gengive

forbicine per sutura



1 Spencer
9 cm
0320-1



2 Spencer
13 cm
0320-2



1 Mayo
retta
14,5 cm
0325-1



2 Mayo
curva
14,5 cm
0325-2



Stevens
retta
11,5 cm
0330-1



Stevens
curva
11,5 cm
0330-2



Stevens
punte stondate rette
11,5 cm
0329-1

forbicine per separare



1 Metzenbaum
retta
14,5 cm
0321-1



2 Metzenbaum
curva
14,5 cm
0321-2



1 Metzenbaum-Delikat
retta
14,5 cm
0322-1



2 Metzenbaum-Delikat
curva
14,5 cm
0322-2



Stevens
retta
11,5 cm
0328-1



Stevens
curva
11,5 cm
0328-2



Stevens
punte stondate curve
11,5 cm
0329-2

Porta aghi



Olsen-Hegar
con forbice
14 cm
0400-14



TC Olsen-Hegar
14 cm
0405-14TC



Baumgartner
14,5 cm
0404-14



TC Hegar-Baumgartner
14 cm
0409-14TC



Crile-Wood
15 cm
W0411-15



Crile-Wood
15 cm
0410-15



TC Crile-Wood
15 cm
0415-15TC



Adson
17,5 cm
0403-17



TC Crile-Wood
15 cm
W0411-15TC

Porta aghi

0409-14TC



Porta aghi

Porta aghi



Mayo-Hegar
16 cm
0420-16



TC Mayo-Hegar
16 cm
0425-16TC



Mayo-Hegar
16 cm
W0412-16



Derf
12 cm
0401-12



TC Derf
12 cm
0406-12TC



TC Halsey-Smooth
punte lisce
13 cm
0407-13TC



Mayo-Hegar
18 cm
0420-18



TC Mayo-Hegar
18 cm
0425-18TC



TC Mayo-Hegar
16 cm
W0412-16TC



TC Mini-Ryder
18 cm
0416-18TC



TC Mini-Ryder
15 cm
0416-15TC



TC Halsey
13 cm
0408-13TC

Porta aghi



Gillies
con forbice
16 cm
0414-16



TC Gillies
con forbice
16 cm
0419-16TC



TC Fine Swedish
15 cm
0417-15TC

Porta aghi



Lichtenberg
movimento leggero
17 cm
0432-17



TC Lichtenberg
17 cm
0437-17TC



Eiselberg-Mathieu
19,5 cm
0422-19



Toennis
modello leggero
18 cm
0421-18



TC Toennis
modello leggero
18 cm
0426-18TC



TC Micro-Vascular
15 cm
0418-15TC



Arruga
16 cm
0433-16



TC Arruga
16 cm
0438-16TC

Porta aghi



Mathieu
14 cm
0430-14



Mathieu
14 cm
0431-14



Mathieu
con forbice
14 cm
0432-14

Porta aghi



TC Mathieu
14 cm
0435-14TC



TC Mathieu
14 cm
0436-14TC



TC Micro-Barraquer
punte curve
18 cm
0451-18TC



Mathieu
17 cm
0430-17



Mathieu
17 cm
0431-17



TC Mathieu
14 cm
0432-14TC



TC Mathieu
17 cm
0435-17TC



TC Mathieu
17 cm
0436-17TC



TC Micro-Barraquer
18 cm
0450-18TC

Porta aghi



TC Castroviejo
punte curve
15,5 cm
PR0460-15TC



Castroviejo
14 cm
0440-14



Castroviejo
punte curve
14 cm
0441-14



Castroviejo
14 cm / 60°
0443-14



TC Castroviejo
14 cm
0445-14TC



TC Castroviejo
14 cm
0446-14TC



TC Castroviejo
14 cm / 60°
0448-14TC

Porta aghi



Castroviejo
13 cm
0442-13



Castroviejo
punte lisce
13 cm
0442-13L



Castroviejo-Barraquer
punte lisce
12 cm
0444-12L



TC Castroviejo
13 cm
0447-13TC



Castroviejo
18 cm
0440-18



Castroviejo
punte curve
18 cm
0441-18



TC Castroviejo
18 cm
0445-18TC



TC Castroviejo
18 cm
0446-18TC

Pinze emostatiche



1 Crile
retta
14 cm
0520-1



2 Crile
curva
14 cm
0520-2



1 Kocher 1x2
retta
14 cm
0530-1

Pinze emostatiche



1 Halstead-Mosquito
retta
12 cm
0500-1



1 Halstead-Mosquito
retta
12 cm
W0502-1



2 Halstead-Mosquito
curva
12 cm
0500-2



2 Kocher 1x2
curva
14 cm
0530-2



1 Pean
retta
14 cm
0540-1



2 Pean
curva
14 cm
0540-2



2 Halstead-Mosquito
curva
12 cm
W0502-2



1 Halstead-Mosquito 1x2
retta
12 cm
0505-1



2 Halstead-Mosquito 1x2
curva
12 cm
0505-2

Pinze emostatiche



1 Micro-Mosquito
retta
10 cm
0501-1



2 Micro-Mosquito
curva
10 cm
0501-2



1 Micro-Mosquito 1x2
retta
10 cm
0506-1



2 Micro-Mosquito 1x2
curva
10 cm
0506-2



Pinze emostatiche



1 Kelly
retta
14 cm
0510-1



2 Kelly
curva
14 cm
0510-2



1 Hartmann
retta
10 cm
0515-1



2 Hartmann
curva
10 cm
0515-2



Bisturi a lama orientabile

Pinza togliame bisturi

Bisturi monouso *

10 pz / confezione

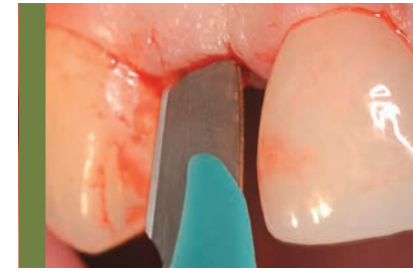

0371-10
Affilate e sottili, le lame dei bisturi monouso mantengono intatta la loro efficacia sia per incisioni superficiali che a livello del periostio.



16 cm
0335-1

16,5 cm
0352



S0352
serie composta da 0352 pinza togliame +
0335-1 manico per bisturi a lama orientabile



0371-10

0371-11

0371-12

0371-15

Manici per bisturi



3
13 cm
0350-3
3
12 cm
W0349-3
3G
13 cm
0350-3G
8
13 cm
0350-8
5
14,5 cm
0350-5
5A
14,5 cm
0350-5A
7
16 cm
0350-7

Lame per bisturi *

100 pz (sterili) / confezione



12D
a doppio taglio
0351-12D
15C
0351-15C
10
0351-10
11
0351-11
12
0351-12
15
0351-15

Manici per bisturi



4
0360-4

Lame per bisturi *

100 pz (sterili) / confezione



20
0361-20
21
0361-21



22
0361-22
23
0361-23



24
0361-24

Micro lame *

25 pz (sterili) / confezione



4
0366-4



13,5 cm
0365-1



4
0366-4



7
0366-7

Siringhe

non autoaspiranti



cartuccia da 1,8 ml
filettatura metrico decimale
0483-2



cartuccia da 1,8 ml
filettatura metrico decimale
0483-3



cartuccia da 2,2 ml
filettatura imperiale (Whitworth)
0482-3W



cartuccia da 2,2 ml
filettatura imperiale (Whitworth)
0482-4W

Siringhe

puntale a cavatappi



cartuccia da 1,8 ml
filettatura metrico decimale
0480-1



cartuccia da 1,8 ml
filettatura metrico decimale
0480-2



cartuccia da 1,8 ml
filettatura metrico decimale
0480-4

autoaspiranti



cartuccia da 1,8 ml
filettatura metrico decimale
0480-5



cartuccia da 1,8 ml
filettatura metrico decimale
0480-6



cartuccia da 1,8 ml
filettatura metrico decimale
0483-1



cartuccia da 2,2 ml
filettatura imperiale (Whitworth)
0482-6W



cartuccia da 1,8 ml
filettatura imperiale (Whitworth)
0480-4W



cartuccia da 1,8 ml
filettatura metrico decimale
0480-3

puntali di ricambio per
0480-1
0480-2
0480-3
0480-4



filettatura metrico decimale
0480-P1



filettatura imperiale (Whitworth)
0480-P2

Siringhe

per anestesia Intraligamentare

siringa in acciaio inox



cartuccia da 1,8 ml
filettatura metrico decimale
0481-8

siringa in ottone con parti meccaniche in acciaio inox



cartuccia da 1,8 ml
filettatura metrico decimale
0481-7



cartuccia da 2,2 ml
filettatura imperiale (Whitworth)
0482-7W

Protezione in plastica autoclavabile



0481-T1

base di appoggio per siringa



0482-1

Pinze per pannilino



1 Backhaus
8 Cm
0550-1



2 Backhaus
11 Cm
0550-2



3 Backhaus
13 Cm
0550-3



Schaedle
9 Cm
0680



Jones
9 Cm
0681



Pinze porta tamponi



Gross-Maier
retta
20 cm
0555-1



Gross-Maier
retta
25 cm
0557-1



Gross-Maier
curva
20 cm
0555-2



Gross-Maier
curva
25 cm
0557-2



Apribocca

per adulti



Molt
14 cm
1870-2

per bambini



Molt
11 cm
1870-1



Roser-Koenig
19 cm
1871-2



Roser-Koenig
16 cm
1871-1

Pinze tirlingua



Collin
16 cm
0560



Young
17 cm
0561

0561-R



Divaricatori - Abbassalingua

divaricatori per labbra

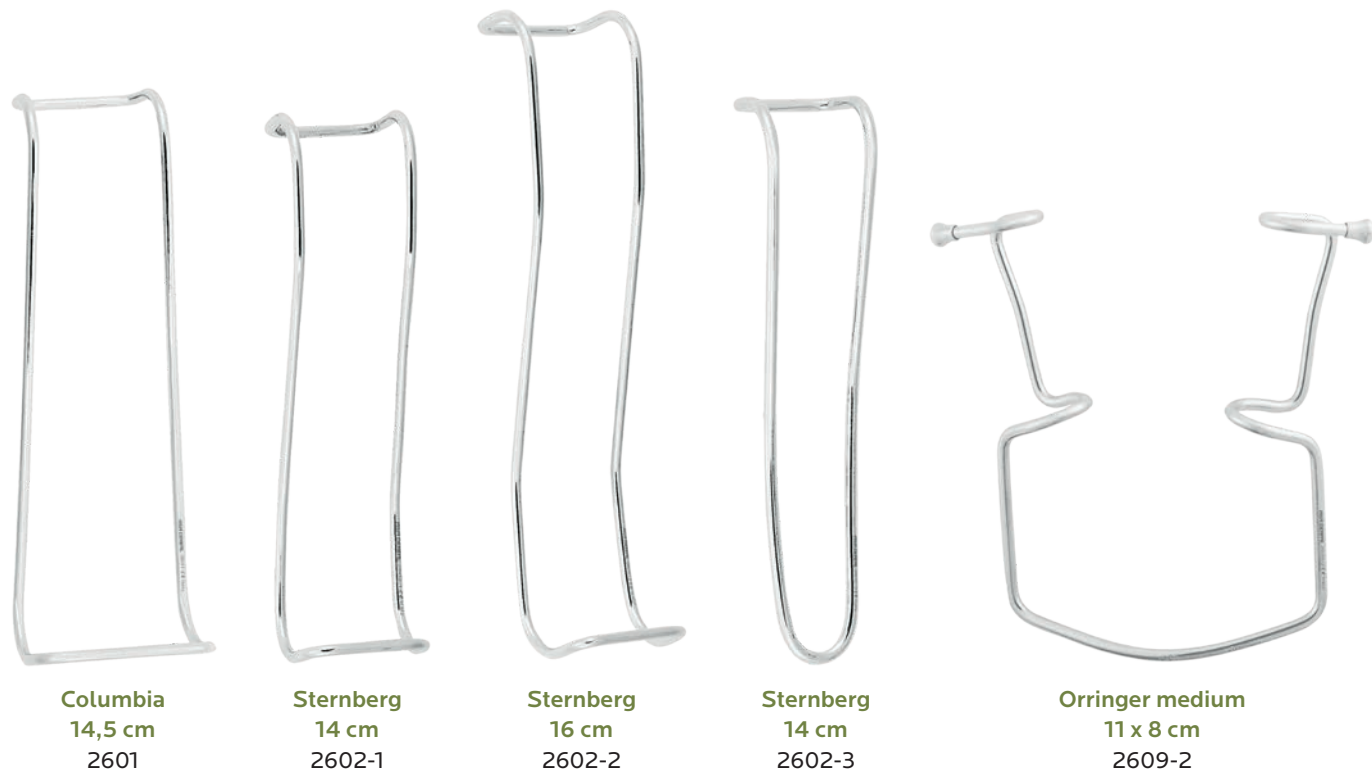

Columbia
14,5 cm
2601

Sternberg
14 cm
2602-1

Sternberg
16 cm
2602-2

Sternberg
14 cm
2602-3

Orringer medium
11 x 8 cm
2609-2

abbassalingua



14,5 cm
2605

14,5 cm
2606

Buchwald
17 cm
2607

Brünings
19 cm
2608

University of Minnesota
14 cm
2604

divaricatore per guance

Divaricatori



arrotondato
16 cm
2611-2

Senn-Miller arrotondato
16 cm
2613-2

arrotondato
16 cm
2611-1

Senn-Miller acuto
16 cm
2613-1

Kilner
15 cm
2615-1

Farabeuf
13 cm
2616-1



Williger retto acuto
13 cm
2617-1

Williger retto arrotondato
13 cm
2618-1

Williger sinistro arrotondato
13 cm
2618-2

Williger sinistro acuto
13 cm
2617-2

Williger destro acuto
13 cm
2617-3

Williger destro acuto
13 cm
2617-33

Divaricatori



divaricatori per spina nasale



Divaricatori



divaricatore labiale



Sonde seno mascellare

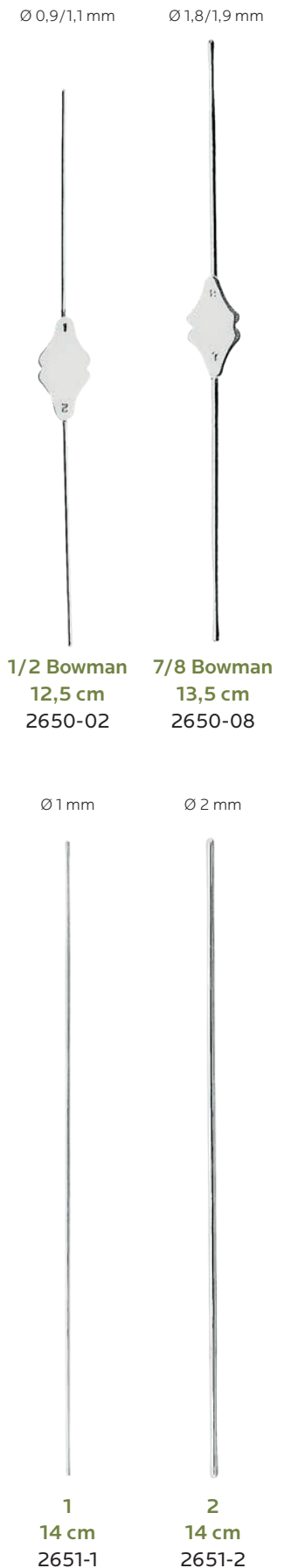

Pinzette chirurgiche

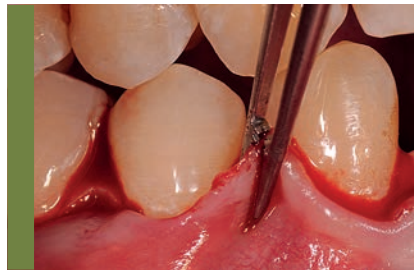

PR0632-1
PINZETTE CHIRURGICHE ATRAUMATICHE CON PUNTE SOTTILI
Pinzette ideali per manipolare i tessuti e facilitare le operazioni di sutura
in modo semplice e preciso.

0,8 mm



Cooley
17,5 cm
PR0632-1



1
Adson
12 cm
0620-1



1
Adson 1x2
12 cm
0621-1



1
Micro-Adson 1x2
12 cm
0622-1

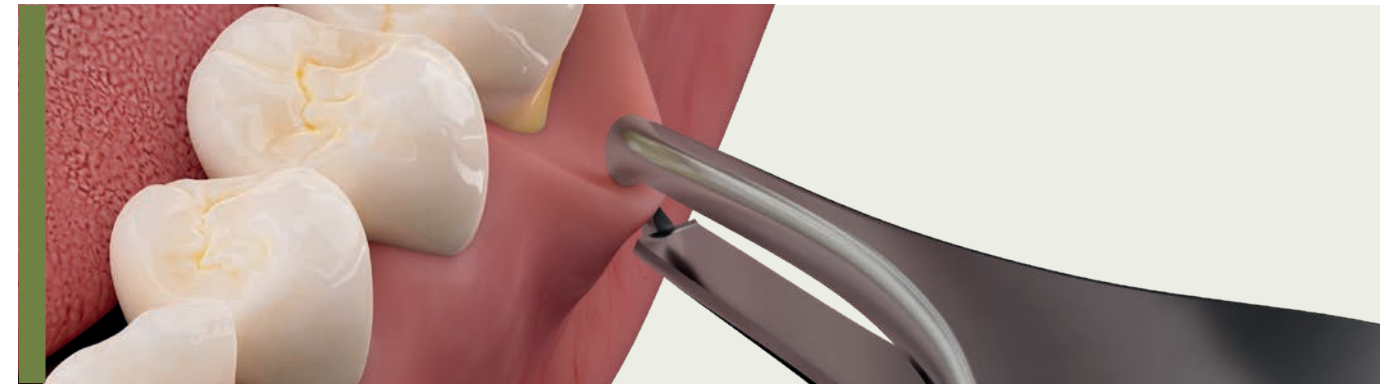

0622-2



2
Micro-Adson 1x2
15 cm
0622-2



10 cm
0623-1



Micro-Adson
12 cm
0624-1



Micro-Adson
15 cm
0624-2

Pinzette chirurgiche

pinzette per sutura

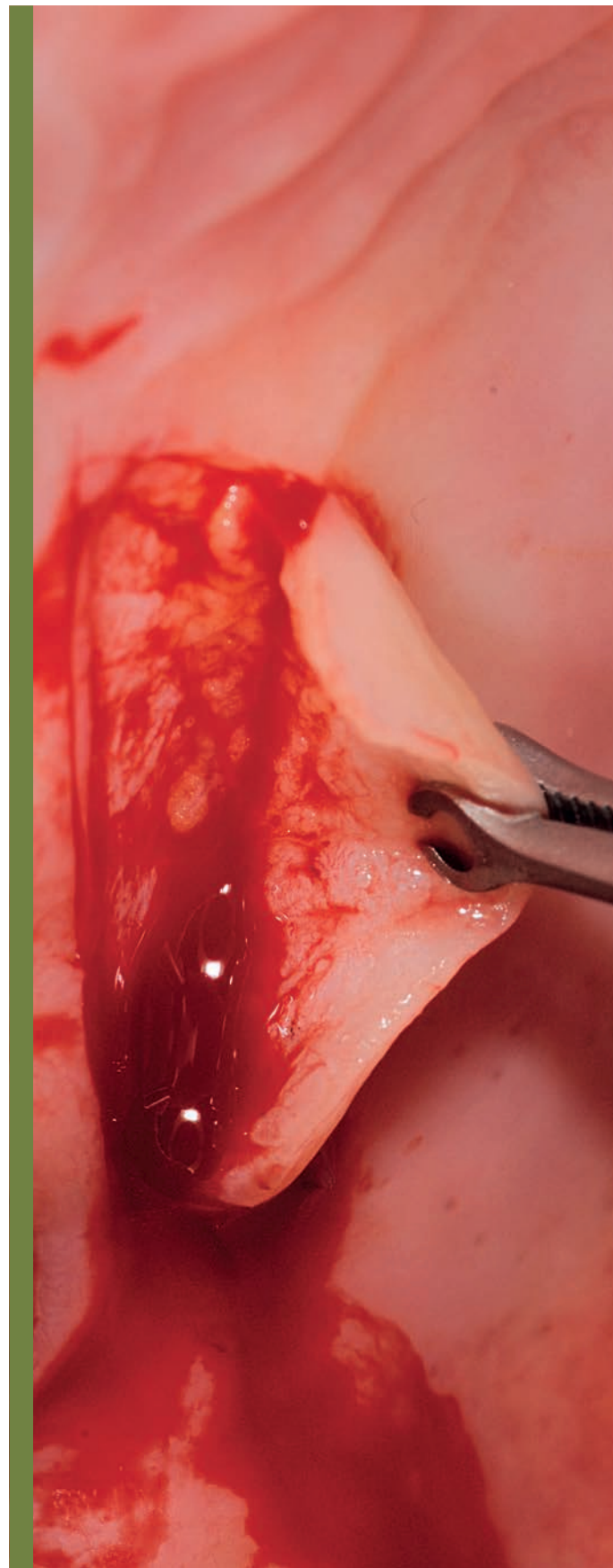

PR0625-3
Consente la manipolazione atraumatica del lembo chirurgico e facilita la sutura.



16 cm
PR0625-2



17 cm
PR0625-3



1
15 cm
0625-1



Adson Brown
atraumatica
12 cm
0626-1



1
Semken-Taylor
12,5 cm
0630-1



2
Semken-Taylor
12,5 cm
0630-2



1
Semken-Taylor 1x2
12,5 cm
0631-1



2
Semken-Taylor 1x2
12,5 cm
0631-2

Pinzette chirurgiche

set da 5



1 · 2 · 3 · 4 · 5
S0645

punte molto fini



1
12,5 cm
0645-1



2
12 cm
0645-2



3
11,5 cm
0645-3



4
11,5 cm
0645-4



5
11,5 cm
0645-5



1
13 cm
0635-1



2
14 cm
0635-2



3
15 cm
0635-3



4
18 cm
0635-4



5
20,5 cm
0635-5

Cannule chirurgiche in acciaio inox

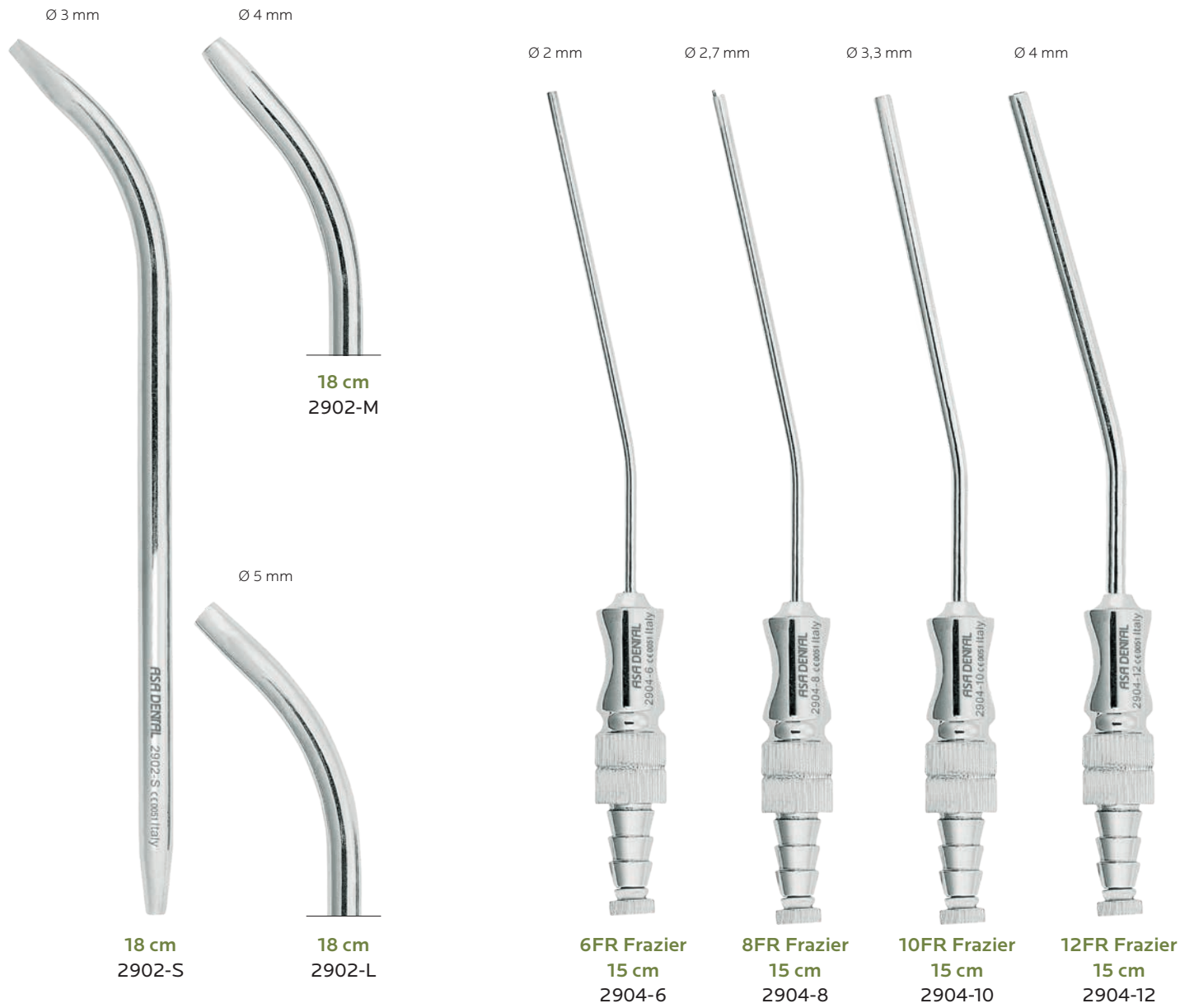

Cannule chirurgiche

cannula sagomata universale per aspiratore chirurgico, sterilizzabile in autoclave



2905-155

adattatore sterilizzabile in autoclave per 2905-155



2905-AD

Cucchiai alveolari



1 Hemingway
2000-1
Asa60
MV 2000-1
Asa Light MV
ML2000-1
Leonardo ML
MC2000-1

● Magic Color MC

2 Hemingway
2000-2
Asa60
MV 2000-2
Asa Light MV
ML2000-2
Leonardo ML
MC2000-2

● Magic Color MC

3 Hemingway
2000-3
Asa60
MV 2000-3
Asa Light MV
ML2000-3
Leonardo ML
MC2000-3

● Magic Color MC

3
2014-3

Kit di strumenti per chirurgia orale



S3002-13

2	pinzetta per medicazioni	0602-2
3	pinzetta chirurgica	0635-3
1	pinzetta per sutura	0625-1
	divaricatore	2611-2
	porta aghi Mathieu	0430-14
	porta aghi Castroviejo	0441-14
	manico per bisturi	0350-3
	forbicina per chirurgia Spencer retta	0320-2
2	forbicina per chirurgia Metzenbaum curva	0321-2
	manico per specchietti	2102-IN
	divaricatore Buchwald	2607
4	specchietto	2200-4
	vassoio	S2722-1

Kit di strumenti per chirurgia orale

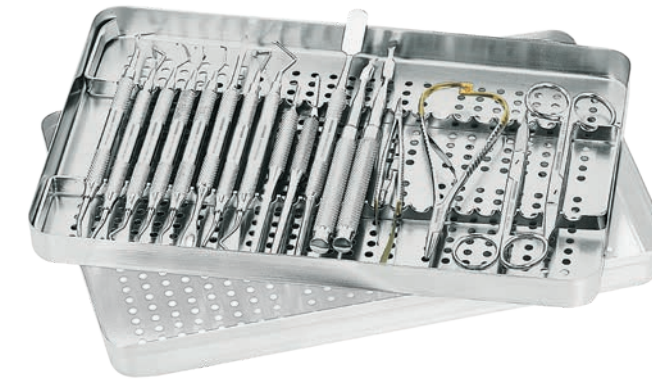

S3002-18

7/8	curette Gracey	MV1807-08
11/12	curette Gracey	MV1807-12
13/14	curette Gracey	MV1807-14
1	forbicina Goldman-Fox retta	0304-1
2	forbicina Goldman-Fox curva	0304-2
85	cucchiaio alveolare Lucas	MV2001-85
86	cucchiaio alveolare Lucas	MV2001-86
1/2	bisturi Kirkland	MV1803-D
1/2	bisturi Orban	MV1804-D
M9	scollaperiostio Molt	MV1850-M9
PR3	scollaperiostio Prichard	MV1851-PR3
5	manico per bisturi retto	0350-5
5A	manico per bisturi curvo	0350-5A
1	scalpello Ochsenbein	1800-1
2	scalpello Ochsenbein	1800-2
	porta aghi Castroviejo	0445-14TC
	porta aghi Mathieu	0435-14TC
	vassoio	S2722-2



S3002-17

	manico per specchietti	2102-IN
23	sonda	0700-23
2	pinzetta per medicazioni London-College	0601-2
1	pinzetta chirurgica Semken-Taylor	0631-1
7	bisturi Goldman-Fox	1815-7
1/2	bisturi Orban	1804-D
M9	scollaperiostio Molt	MV1850-M9
PR3	scollaperiostio Prichard	MV1851-PR3
	divaricatore Farabeuf	2616-1
	divaricatore Sternberg	2602-1
	divaricatore Senn-Miller	2613-2
	porta aghi Crile-Wood	0415-15TC
	porta aghi Mathieu	0430-14
2	forbicina Goldman-Fox	0304-2
1	pinza emostatica Halstead-Mosquito retta	0500-1
2	pinza emostatica Halstead-Mosquito curva	0500-2
5	specchietto	2200-5
	vassoio	S2722-1



ASA DENTAL

MAKE PEOPLE SMILE

CHIRURGIA ESTRATTIVA

MADE IN ITALY

RISOLVERE IL PRESENTE, PROGETTANDO IL FUTURO

L'estrazione di un dente è sempre considerata una misura estrema, spesso dettata da una condizione di dolore per il paziente. Anche le estrazioni più semplici comportano manovre attente e scrupolose, al fine di preservare l'osso e di non compromettere futuri interventi di chirurgia implantare. Tuttavia, l'esperienza dei professionisti e la letteratura medica riportano casi che presuppongono procedure ben più complesse. Un molare spezzato all'altezza della gengiva, un dente del giudizio incluso o semi-incluso, un molare che stenta ad uscire: l'estrazione si trasforma in un'operazione chirurgica a tutti gli effetti, rivolta a creare un accesso attraverso la gengiva ed a minimizzare la quantità di osso sacrificato. Precisione assoluta e invasività minimale richiedono un ampio range di strumenti dalle caratteristiche superiori, compresa la necessaria varietà di leve, per poter affrontare qualsiasi tipo di intervento.

- D4 Pinze per estrazione
- D37 Pinze per estrazione per bambini
- D40 Pinze per radici e frammenti
- D42 Pinze ossivore alveolotome
- D44 Pinze per tessuti
- D45 Leve per radici
- D63 Mini-leve per frammenti di radici
- D65 Sindesmotomi
- D68 Periotomi
- D68 Dissettori
- D69 Kit
- D71 Accessori

Pinze per estrazione

con profilo ritentivo



S0100-1

1	0100-1
17	0100-17
18	0100-18
79	0100-79
67A	0100-67A
51A	0100-51A
13	0100-13
22	0100-22



1
17 cm
0100-1
incisivi e canini superiori

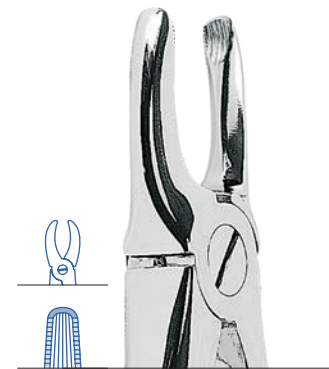

3
17 cm
0100-3
incisivi e canini superiori sovrapposti

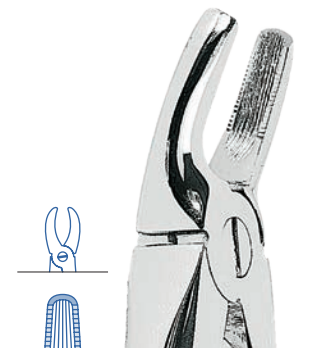

7
17 cm
0100-7
incisivi superiori premolari superiori

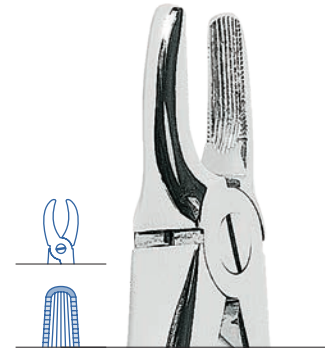

2
18 cm
0100-2
incisivi e canini superiori

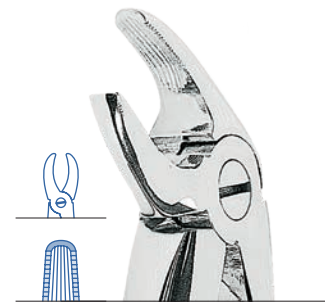

4
14 cm
0100-4
incisivi e canini inferiori

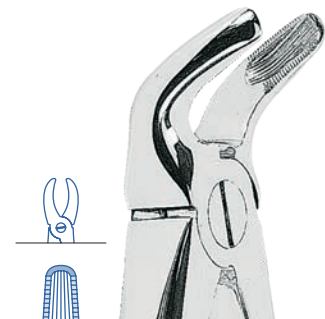

8
16 cm
0100-8
premolari inferiori

Pinze per estrazione

con profilo ritentivo



S0100-2

1	0100-1
7	0100-7
17	0100-17
18	0100-18
4	0100-4
13	0100-13
22	0100-22
86C	0100-86C



13
15 cm
0100-13
premolari inferiori



18
17 cm
0100-18
molari superiori sinistri

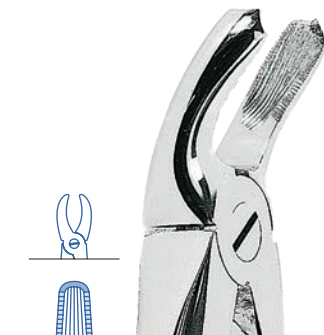

20
14 cm
0100-20
denti del giudizio inferiori

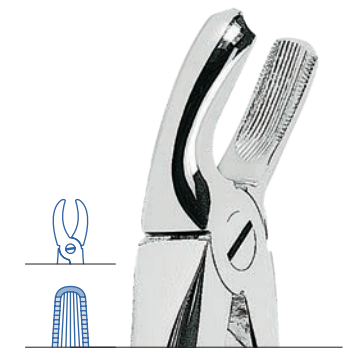

17
17 cm
0100-17
molari superiori destri

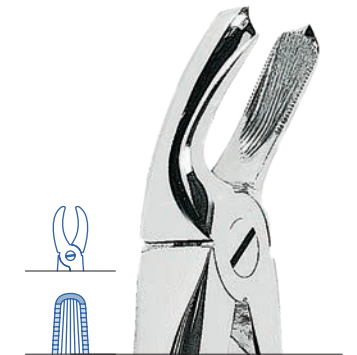

18A
17 cm
0100-18A
molari superiori



21
16 cm
0100-21
molari inferiori

Pinze per estrazione

con profilo ritentivo



19
17 cm
0100-19
denti del giudizio
superiori



22
15 cm
0100-22
molari inferiori



22L Routurier
18 cm
0100-22L
molari e denti del giudizio
inferiori sinistri



22R Routurier
18 cm
0100-22R
molari e denti del giudizio
inferiori destri



23
0100-23
15 cm
molari inferiori
destri



24
15 cm
0100-24
molari inferiori
sinistri

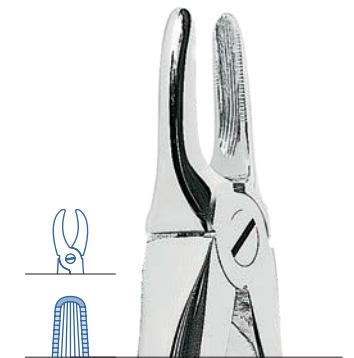

29
17 cm
0100-29
radici superiori

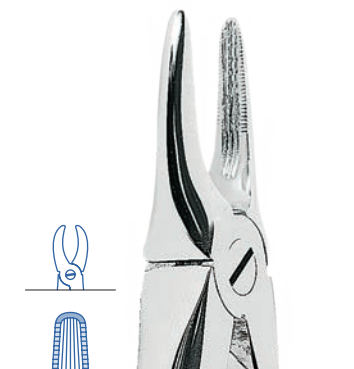

29N
17 cm
0100-29N
radici e incisivi
superiori

Pinze per estrazione

con profilo ritentivo

Pinze per estrazione

con profilo ritentivo



0100-45
Pinze con punte curve e profilo ritentivo indicate per l'estrazione di radici inferiori.



30
17 cm
0100-30
radici superiori

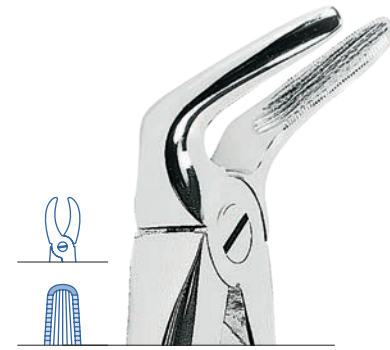

31
16 cm
0100-31
radici e incisivi inferiori



33
15 cm
0100-33
radici inferiori



33A
15 cm
0100-33A
radici inferiori



33L
15 cm
0100-33L
radici inferiori



38A
15 cm
0100-38A
denti inferiori fratturati o parzialmente rotti



41
19 cm
0100-41
radici superiori



43A
17 cm
0100-43A
denti superiori fratturati o parzialmente rotti



44
19 cm
0100-44
radici superiori



45
18 cm
0100-45
radici inferiori

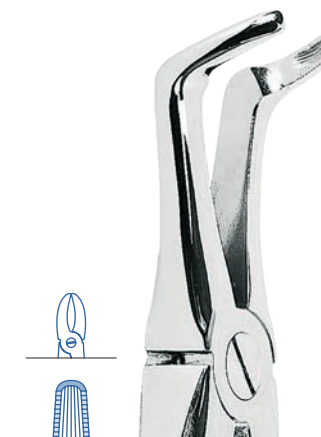

46
18 cm
0100-46
radici inferiori



46L
18 cm
0100-46L
radici inferiori

Pinze per estrazione

con profilo ritentivo



48
19 cm
0100-48
radici superiori



49
19 cm
0100-49
radici superiori

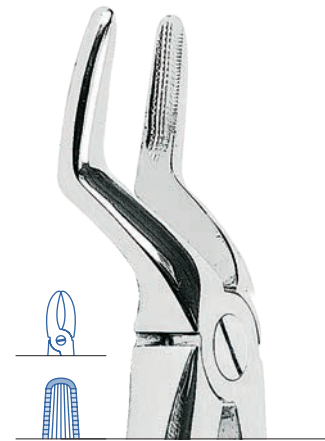

51
18 cm
0100-51
radici superiori



51A
18 cm
0100-51A
radici superiori



51L
19 cm
0100-51L
radici superiori

Pinze per estrazione

con profilo ritentivo



51LX
20 cm
0100-51LX
radici superiori



52
18 cm
0100-52
radici superiori
e canini



54
17 cm
0100-54
per separare
molari superiori



55
17 cm
0100-55
per separare
molari superiori



56
16 cm
0100-56
per separare
molari inferiori



59
15 cm
0100-59
radici inferiori



59L
16 cm
0100-59L
radici incisivi inferiori

Pinze per estrazione

con profilo ritentivo

Pinze per estrazione

con profilo ritentivo



60
15 cm
0100-60
radici inferiori

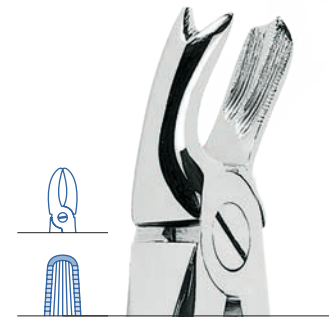

65L
17 cm
0100-65L
molari superiori
sinistri



65R
17 cm
0100-65R
molari superiori
destri



66L
17 cm
0100-66L
molari superiori
sinistri



66R
17 cm
0100-66R
molari superiori
destri



67
18 cm
0100-67
denti del giudizio
superiori



67A
19 cm
0100-67A
denti del giudizio
superiori



67 1/2 L
18 cm
0100-67/L
denti del giudizio
superiori sinistri



67 1/2 R
18 cm
0100-67/R
radici incisivi inferiori

Pinze per estrazione

con profilo ritentivo



68
18 cm
0100-68
radici inferiori



73
16 cm
0100-73
molari inferiori



74
16 cm
0100-74
radici inferiori



74M
15 cm
0100-74M
radici inferiori



74N
16 cm
0100-74N
radici inferiori

Pinze per estrazione

con profilo ritentivo



75
16 cm
0100-75
canini e premolari
inferiori



79
17 cm
0100-79
denti del giudizio
inferiori



79A
17 cm
0100-79A
denti del giudizio
inferiori



79C
17 cm
0100-79C
denti del giudizio
inferiori

Pinze per estrazione

senza profilo ritentivo

Pinze per estrazione

senza profilo ritentivo



86 1/2L Routurier
17 cm
0100-86/L
denti del giudizio inferiori sinistri



86 1/2R Routurier
17 cm
0100-86/R
denti del giudizio inferiori destri



86C
16 cm
0100-86C
molari inferiori



86W White
17 cm
0100-86W
per lussazione ultimo molare inferiore



87
16 cm
0100-87
molari inferiori cariati o corone rotte



166 Trotter
17 cm
0100-166
pinza universale per denti superiori, in particolare molari e premolari

Pinze per estrazione

con profilo ritentivo



89
18 cm
0100-89
molari superiori
destri



90
18 cm
0100-90
molari superiori
sinistri



99
16 cm
0100-99
molari inferiori
con corona rotta



107
17 cm
0100-107
canini superiori

Pinze per estrazione

con profilo ritentivo



121 Ogden-Felsch
18 cm
0100-121
denti del giudizio superiori



145
18 cm
0100-145
radici inferiori



151 1/2
19 cm
0100-151/
radici superiori

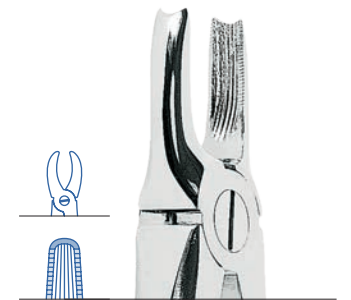

168 Trotter
17 cm
0100-168
canini superiori



346
18 cm
0100-346
radici inferiori

Pinze per estrazione

senza profilo ritentivo

con profilo ritentivo

con profilo ritentivo

Pinze per estrazione - AsaLady

con profilo ritentivo



167 Trotter
16 cm
0100-167
pinza universale per
denti inferiori in particolare
molari e premolari



169 Trotter
16 cm
0100-169
denti del giudizio
superiori



359
16 cm
0100-359
radici inferiori



349
19 cm
0100-349
radici superiori



1
15 cm
W0160-1
incisivi e canini
superiori



2
16 cm
W0160-2
incisivi e canini
superiori



7
15 cm
W0160-7
incisivi superiori
premolari superiori



17
15 cm
W0160-17
molari superiori
destri



4
14 cm
W0160-4
incisivi e canini
inferiori



13
13 cm
W0160-13
premolari inferiori



18
15 cm
W0160-18
molari superiori
sinistri

Pinze per estrazione - AsaLady

con profilo ritentivo

Pinze per estrazione - AsaLady

con profilo ritentivo

senza profilo ritentivo



22
13 cm
W0160-22
molari inferiori



33
13 cm
W0160-33
radici inferiori



W0160-51A
Pinze angolate con profilo ritentivo indicate per l'estrazione di radici superiori.



21
14 cm
W0160-21
molari inferiori



45
16 cm
W0160-45
radici inferiori



51A
17 cm
W0160-51A
radici superiori



79
15 cm
W0160-79
denti del giudizio inferiori



145
16 cm
W0160-145
radici inferiori



86C
14 cm
W0160-86C
molari inferiori



67A
17 cm
W0160-67A
denti del giudizio superiori



74
14 cm
W0160-74
radici inferiori



151 1/2
18 cm
W0160-151/
radici superiori

Pinze per estrazione - MEAD

con profilo ritentivo



1
17 cm
0104-1
pinza universale per
incisivi e canini superiori



2
17 cm
0104-2
molari superiori

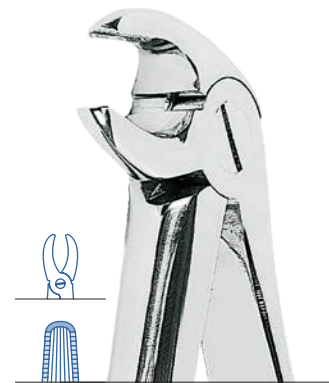

3
15 cm
0104-3
incisivi, premolari
e radici inferiori

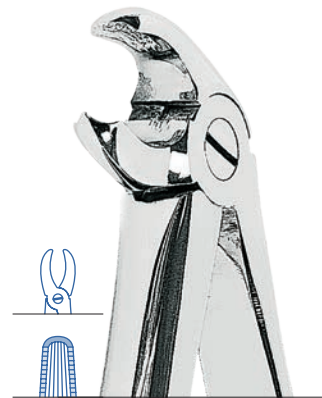

4
15 cm
0104-4
molari inferiori



0104-1

Pinze per estrazione - forma AMERICANA

senza profilo ritentivo



5 Physick
18 cm
0120-5
denti del giudizio
inferiori



6
17 cm
0120-6
pinza per separare



10S
18 cm
0120-10S
molari superiori



16
17 cm
0120-16
molari inferiori



17
18 cm
0120-17
molari inferiori

Pinze per estrazione - forma AMERICANA

senza profilo ritentivo

Pinze per estrazione - forma AMERICANA

senza profilo ritentivo



18L Harris
18 cm
0120-18L
molari superiori
sinistri



18R Harris
18 cm
0120-18R
molari superiori
destri



23
18 cm
0120-23
molari inferiori



65
19 cm
0120-65
incisivi e radici
superiori



69 Tomes
18 cm
0120-69
radici superiori
e inferiori



88R Nevius
18 cm
0120-88R
molari superiori
destri



53R
19 cm
0120-53R
molari superiori
destri



53L
19 cm
0120-53L
molari superiori
sinistri



88L Nevius
18 cm
0120-88L
molari superiori
sinistri



101 Hull
16 cm
0120-101
denti di latte

Pinze per estrazione - forma AMERICANA

senza profilo ritentivo



150 Cryer
18 cm
0120-150
incisivi superiori,
premolari, radici



150S Cryer
16 cm
0120-150S
denti superiori
(per bambini)



151 Cryer
17 cm
0120-151
incisivi inferiori,
premolari, radici



151S Cryer
15 cm
0120-151S
denti inferiori
(per bambini)



222
18 cm
0120-222
denti del giudizio
inferiori

Pinze per estrazione - forma AMERICANA - AsaLady

senza profilo ritentivo



5 Physick
16 cm
W0121-5
denti del giudizio
inferiori



6
16 cm
W0121-6
pinza per separare



10S
17 cm
W0121-10S
molari superiori

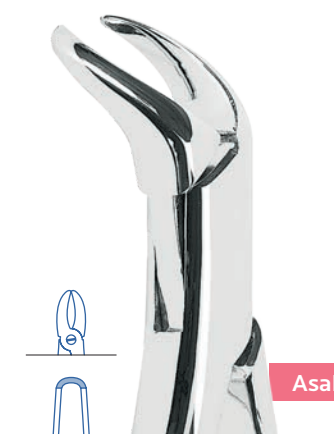

16
16 cm
W0121-16
molari inferiori

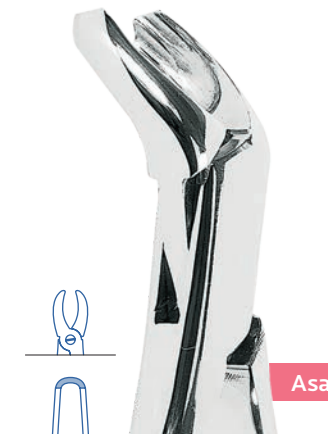

17
16 cm
W0121-17
molari inferiori

W0121-5

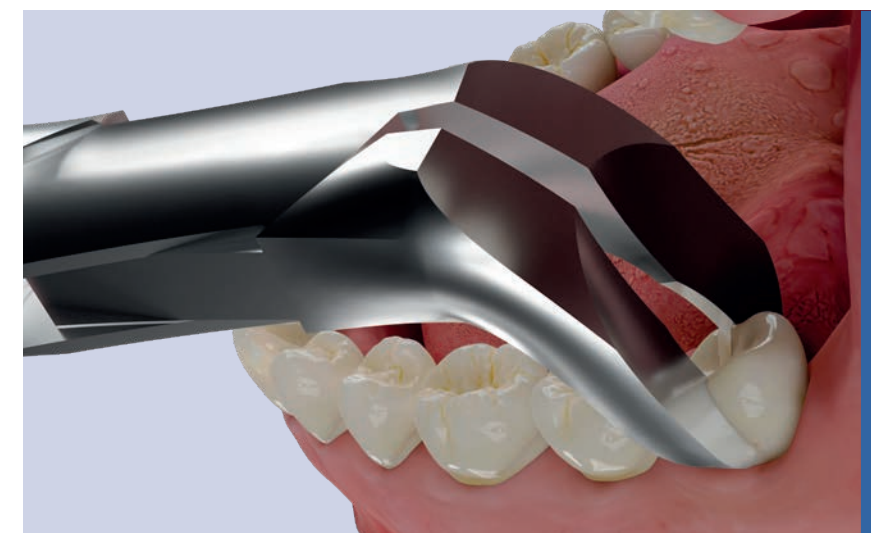

Pinze per estrazione - forma AMERICANA - AsaLady

senza profilo ritentivo

Pinze per estrazione - forma AMERICANA - AsaLady

senza profilo ritentivo



18L Harris
16 cm
W0121-18L
molari superiori
sinistri

AsaLady



18R Harris
16 cm
W0121-18R
molari superiori
destri

AsaLady



23
16 cm
W0121-23
molari inferiori

AsaLady



53R
17 cm
W0121-53R
molari superiori
destri

AsaLady



53L
17 cm
W0121-53L
molari superiori
sinistri

AsaLady



65
18 cm
W0121-65
incisivi e radici
superiori

AsaLady



69 Tomes
18 cm
W0121-69
radici superiori
e inferiori

AsaLady



88L Nevius
17 cm
W0121-88L
molari superiori
sinistri

AsaLady

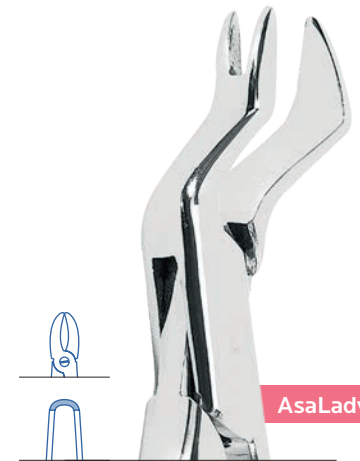

88R Nevius
17 cm
W0121-88R
molari superiori
destri

AsaLady



101 Hull
W0121-101
denti di latte

AsaLady

Pinze per estrazione - forma AMERICANA - AsaLady

senza profilo ritentivo

Pinze per estrazione - manico ANATOMICO

con profilo ritentivo



AsaLady

150 Cryer
17 cm
W0121-150
incisivi superiori,
premolari, radici



AsaLady

150S Cryer
W0121-150S
denti superiori
(per bambini)

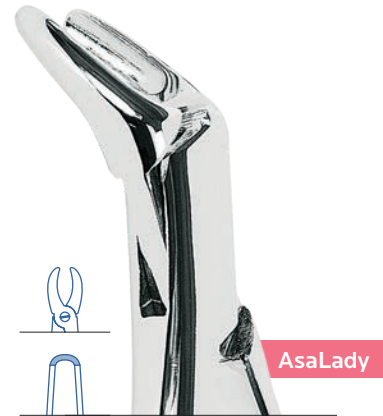

AsaLady

151 Cryer
16 cm
W0121-151
incisivi inferiori,
premolari, radici



AsaLady

151S Cryer
W0121-151S
denti inferiori
(per bambini)



AsaLady

222
17 cm
W0121-222
denti del giudizio
inferiori



1
17 cm
0130-1
incisivi e canini
superiori

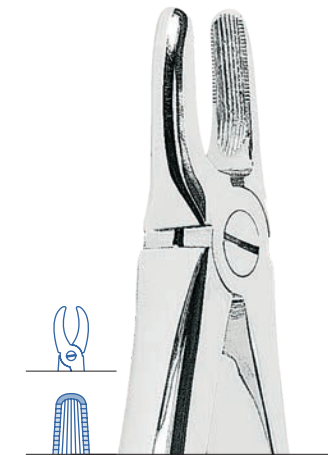

2
17 cm
0130-2
incisivi e canini
superiori



4
16 cm
0130-4
incisivi e canini
inferiori

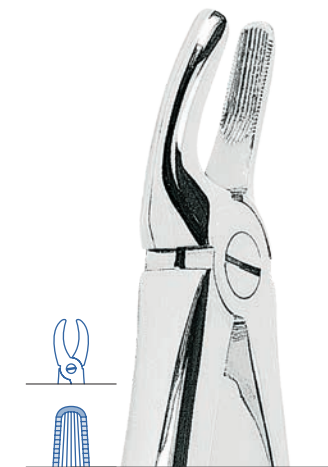

7
16 cm
0130-7
premolari superiori



13
15 cm
0130-13
premolari inferiori

Pinze per estrazione - manico ANATOMICO

con profilo ritentivo

Pinze per estrazione - manico ANATOMICO

con profilo ritentivo



17
17 cm
0130-17
molari superiori
destri

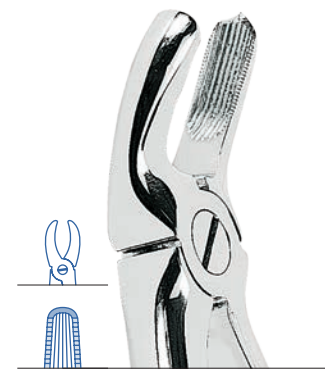

18
17 cm
0130-18
molari superiori
sinistri

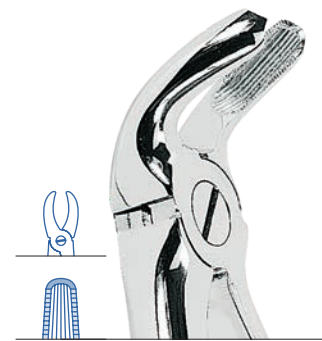

21
17 cm
0130-21
molari inferiori

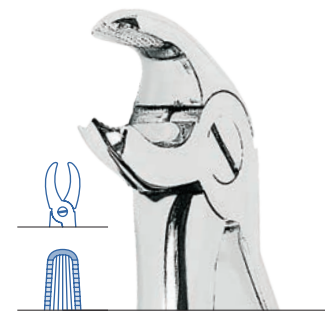

22
15 cm
0130-22
molari inferiori

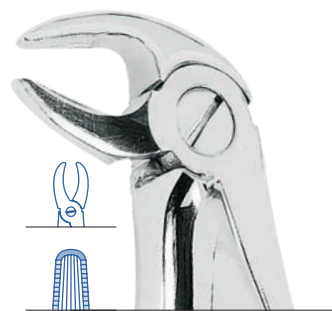

33
15 cm
0130-33
radici inferiori

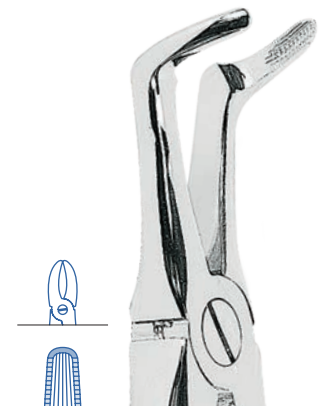

45
18 cm
0130-45
radici inferiori



51A
18 cm
0130-51A
radici superiori



67A
18 cm
0130-67A
denti del giudizio
superiori



74
16 cm
0130-74
radici inferiori

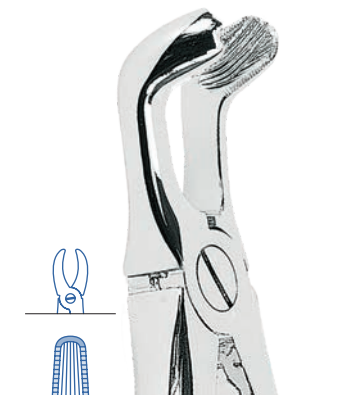

79
17 cm
0130-79
denti del giudizio
inferiori



86C
15 cm
0130-86C
molari inferiori

Pinze per estrazione - manico ANATOMICO

con profilo ritentivo



89
17 cm
0130-89
molari superiori
destri



90
17 cm
0130-90
molari superiori
sinistri



151 1/2
19 cm
0130-151/
radici superiori



359
16 cm
0130-359
radici inferiori



145
18 cm
0130-145
radici inferiori



349
18 cm
0130-349
radici superiori

Pinze per estrazione per bambini

con profilo ritentivo



13S
13 cm
0110-13S
premolari inferiori



22S
14 cm
0110-22S
molari inferiori



33S
14 cm
0110-33S
radici inferiori



30S
15 cm
0110-30S
incisivi e radici
superiori

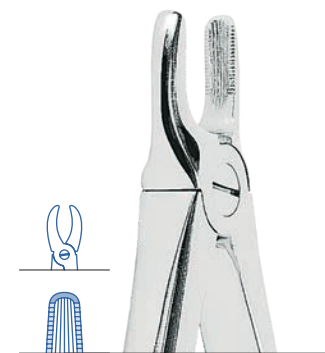

37
15 cm
0110-37
incisivi superiori,
premolari, radici

Pinze per estrazione per bambini

con profilo ritentivo



S0110

37	0110-37
39	0110-39
39R	0110-39R
39L	0110-39L
51S	0110-51S
13S	0110-13S
30S	0110-30S
33S	0110-33S
22S	0110-22S
38	0110-38



38
14 cm
0110-38
incisivi e canini inferiori

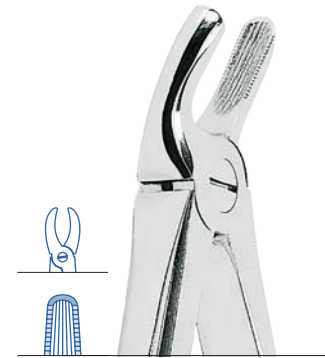

39
15 cm
0110-39
molari superiori



39R
15 cm
0110-39R
molari superiori destri

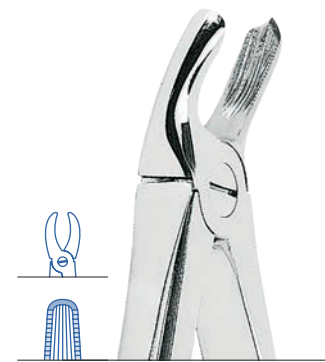

39L
15 cm
0110-39L
molari superiori sinistri



51S
16 cm
0110-51S
radici superiori

Pinze per estrazione per bambini - modello KLEIN

con profilo ritentivo



S0112

1	0112-1	5	0112-5
2	0112-2	6	0112-6
3	0112-3	7	0112-7
4	0112-4		



2
13 cm
0112-2
premolari superiori

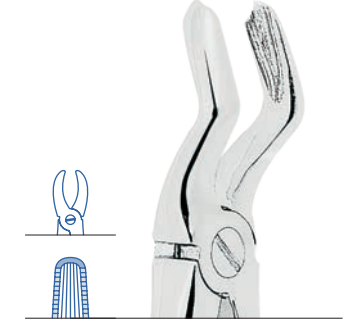

3
13 cm
0112-3
molari superiori



1
12 cm
0112-1
incisivi superiori



4
13 cm
0112-4
radici superiori

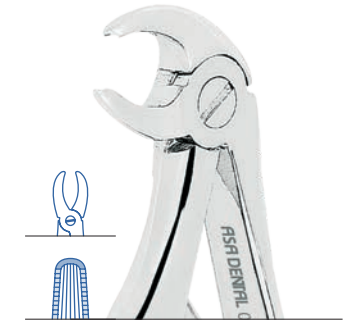

5
11 cm
0112-5
incisivi inferiori

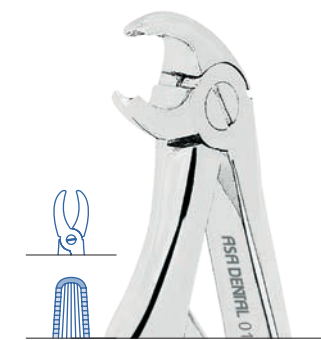

6
11 cm
0112-6
molari inferiori



7
11 cm
0112-7
radici inferiori

Pinze per radici

con profilo ritentivo

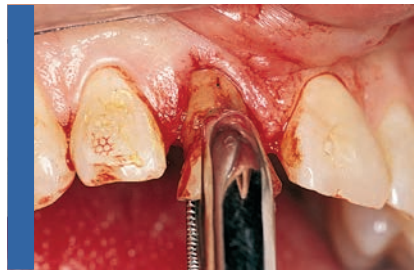

0101-1
Le pinze Witzel sono strumenti per estrazione estremamente versatili che possono essere utilizzati sia per denti che per radici. Il profilo ritentivo, unito alla forma curva e affusolata delle punte, permette a queste pinze di lavorare in modo ottimale sulle radici senza il rischio di causare rotture.

Pinze per radici e frammenti

senza profilo ritentivo



0102-1
Queste pinze sono state concepite per amplificare la sensibilità e garantire la precisione. L'impugnatura tipica delle forbici favorisce la manovrabilità, mentre le punte sottili raggiungono le schegge delle radici anche in profondità, afferrandole saldamente.



1 Witzel
15 cm
0101-1
radici inferiori



2 Witzel
15 cm
0101-2
radici superiori



1 Stieglitz
14 cm
0102-1
frammenti di radici



2 Stieglitz
13 cm
0102-2
frammenti di radici

Pinze ossivore alveolotome

Pinze ossivore alveolotome



Luer
15 cm
0103-10



Friedman
14 cm
0103-20



Mini Friedman
12 cm
0103-25



Cleveland 5
16 cm
0103-40



Cleveland-Gardner
16 cm
0103-45



Blumenthal
15 cm
0103-30



Blumenthal
14 cm
0103-31



Blumenthal
14 cm
0103-32



Mead 1A
16 cm
0103-50

Pinze ossivore alveolotome

doppio snodo

Pinza per tessuti

dimensioni ridotte per accesso
in aree molto limitate

Leve per radici con manico in acciaio inox



0234-1



Mini-Ruskin
15 cm
0103-70



Beyer
17 cm
0103-71



Goldman-Fox
10 cm
0103-60



1 Hylin
0234-1



2 Hylin
0234-2



3 Hylin
0234-3



4 Hylin
0234-4

Leve per radici con manico in acciaio inox



0231-2



Leve per radici con manico in acciaio inox



S0200-6

1B	0200-1
4B	0200-4
2F	0201-2
3F	0201-3
44	0220-44
45	0220-45



Leve per radici con manico in acciaio inox



Leve per radici con manico in acciaio inox



S0200-10

2B	0200-2
3B	0200-3
4B	0200-4
2F	0201-2
3F	0201-3
1	0291-1
2	0291-2
3	0291-3
320	0202-320
321	0202-321



Leve per radici con manico in acciaio inox
con punte elicoidali

Leve per radici con manico in acciaio inox
con punte elicoidali



1K	0244-1
2K	0244-2
3K	0244-3
4K	0244-4
5K	0244-5
6K	0244-6

S0244-6



Leve per radici con manico in acciaio inox

Leve per radici con manico in acciaio inox



Leve per radici con manico in acciaio inox



Leve per radici con manico in acciaio inox



Leve per radici con manico in acciaio inox



Leve per radici con manico in acciaio inox

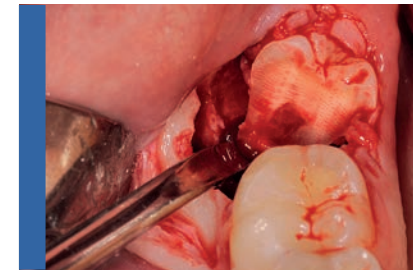

0229-1F
 Quasi tutti i denti del giudizio inferiori inclusi possono essere estratti con questa leva. Inserendola dall'alto nello spazio creato tramite una resezione dell'osso, la leva di Friedman riesce a spostare il dente verso l'alto e all'indietro. Nell'immagine si vedono la leva di Friedman e uno specchietto in azione su un frammento di terzo molare.

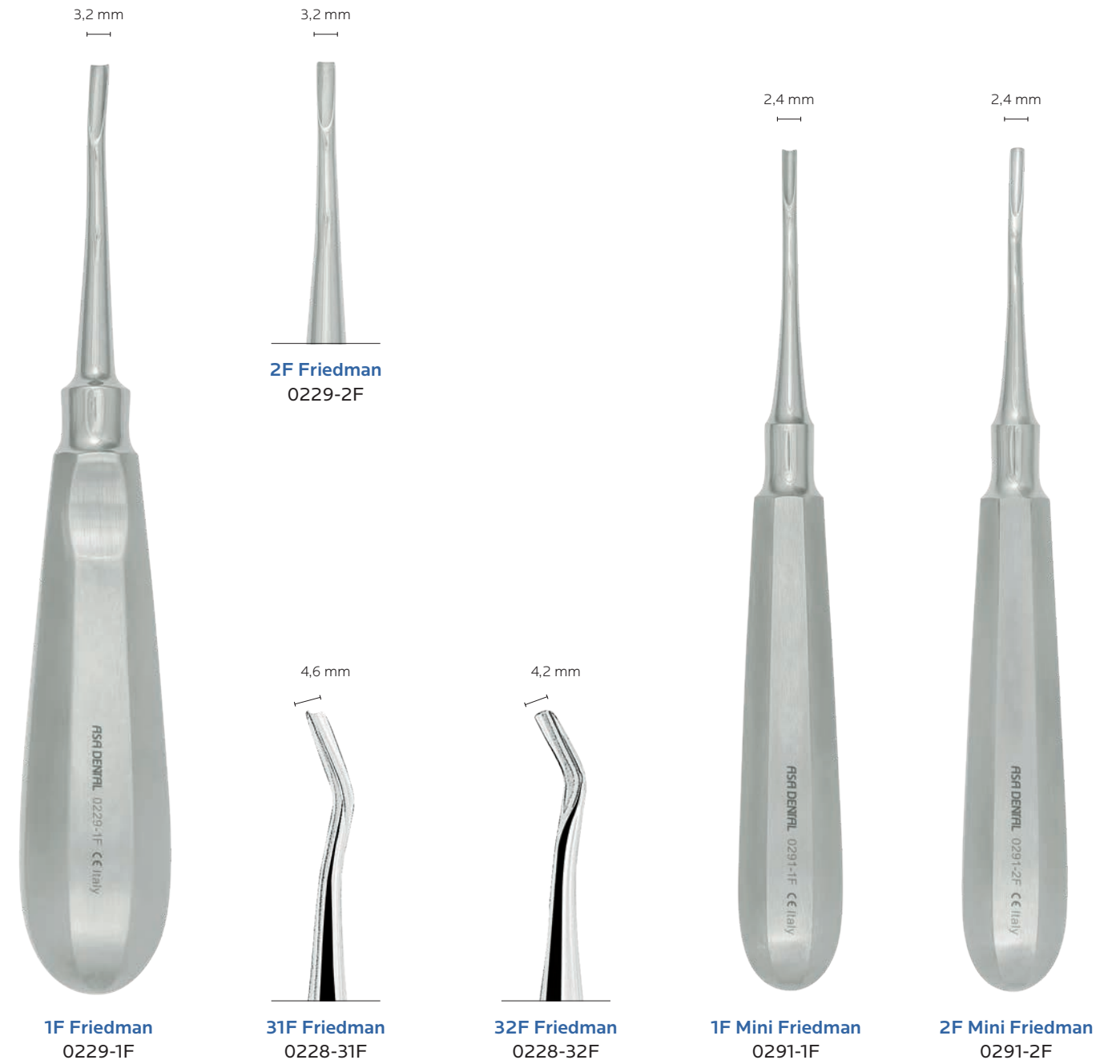

Leve per radici con manico in acciaio inox

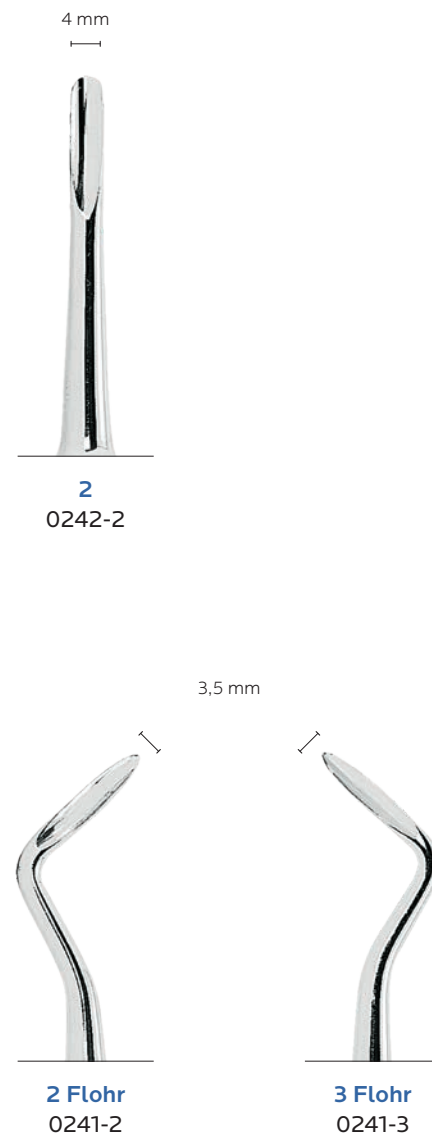

Leve per radici con manico in acciaio inox ANATOMICO

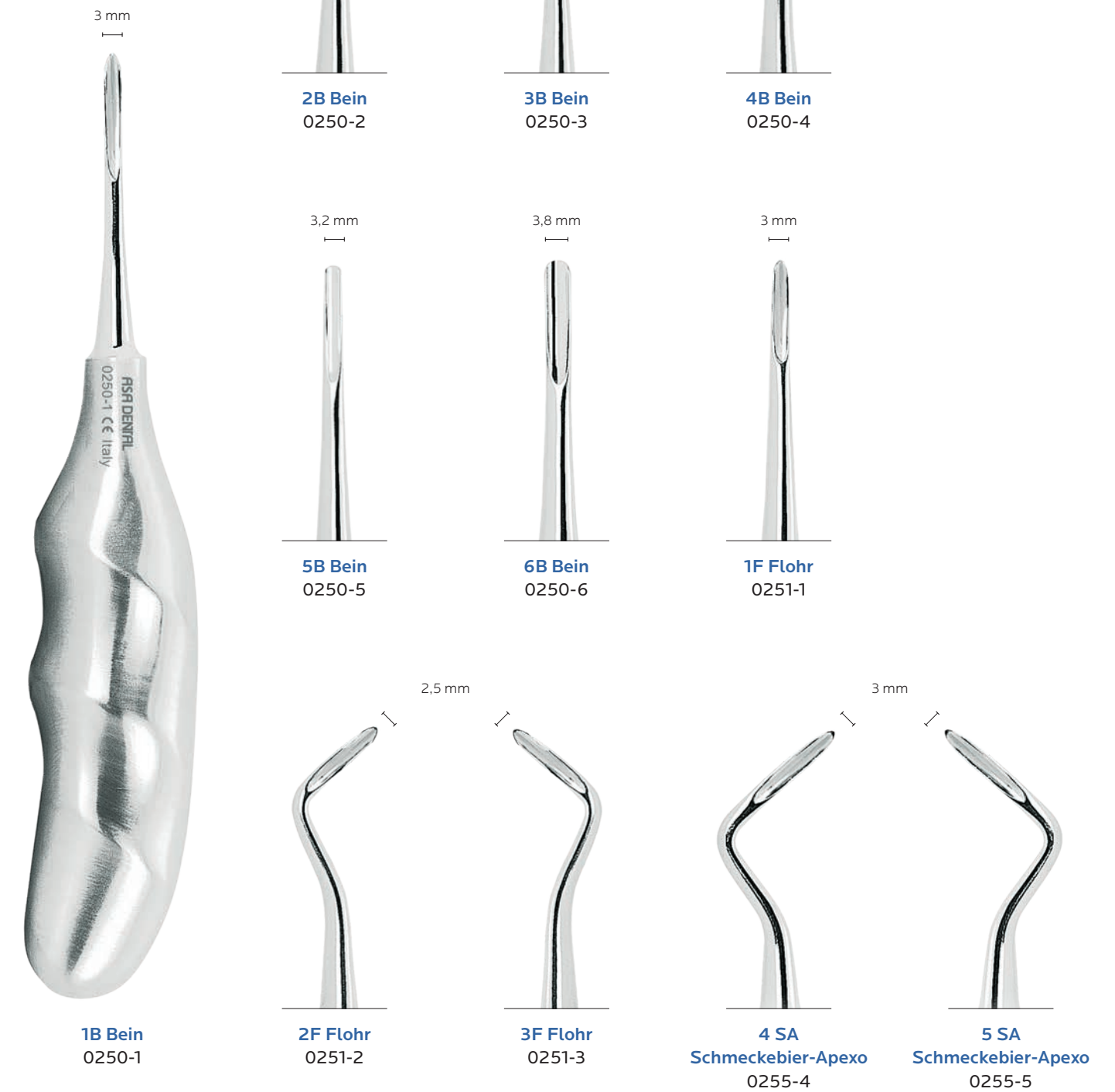

Leve per radici con manico in acciaio inox ANATOMICO

Leve per radici con manico in acciaio inox

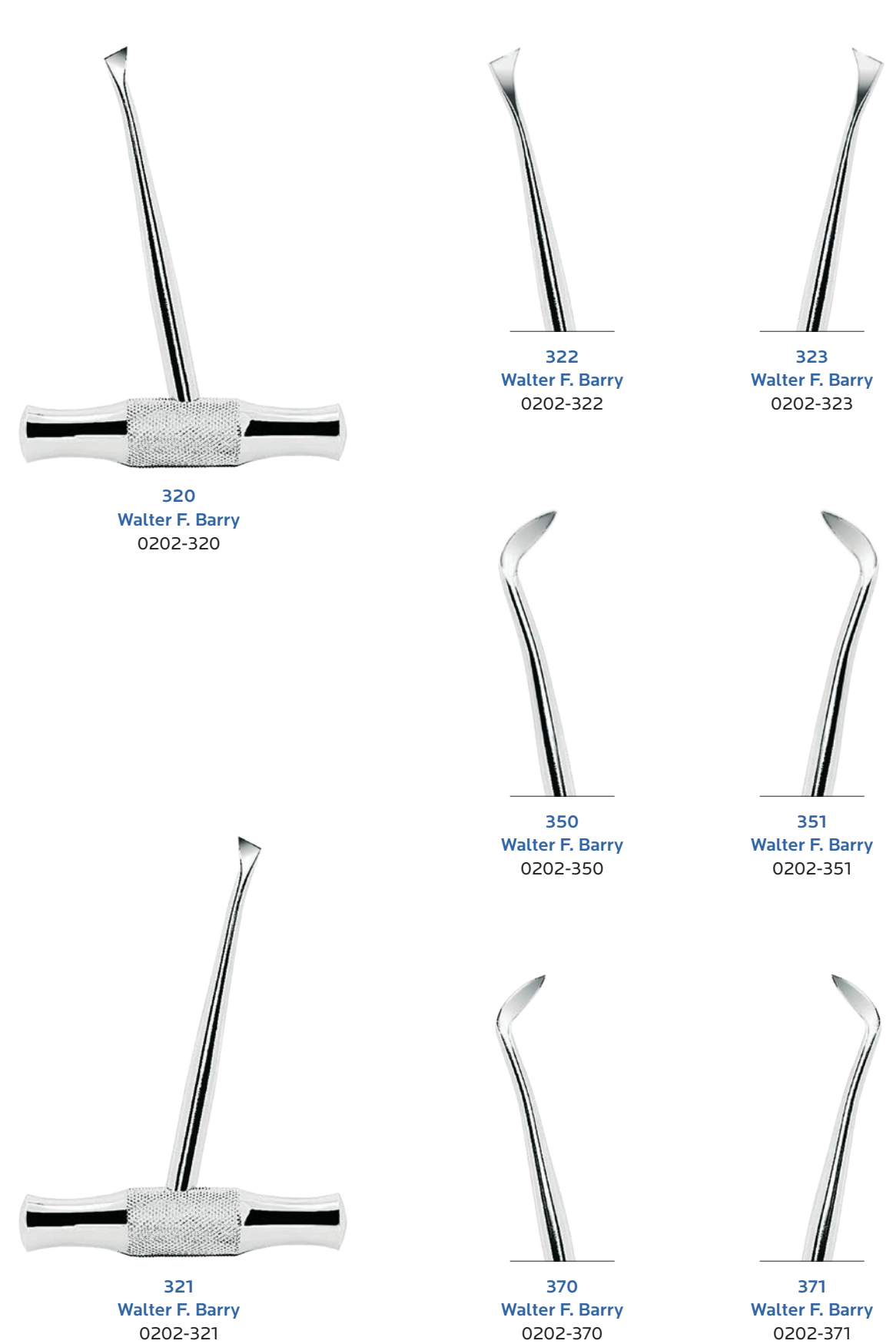

Leve per radici con manico in acciaio inox



Leve per radici con manico in acciaio inox

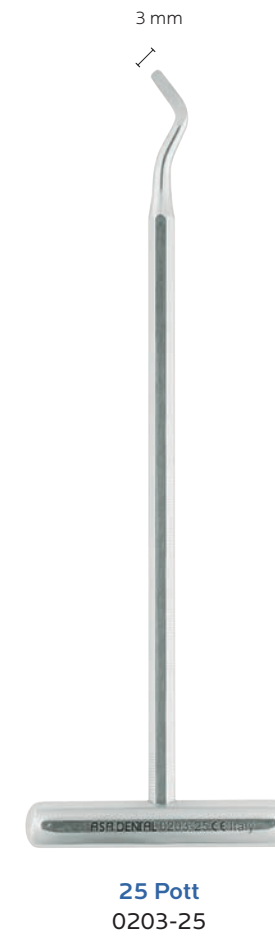
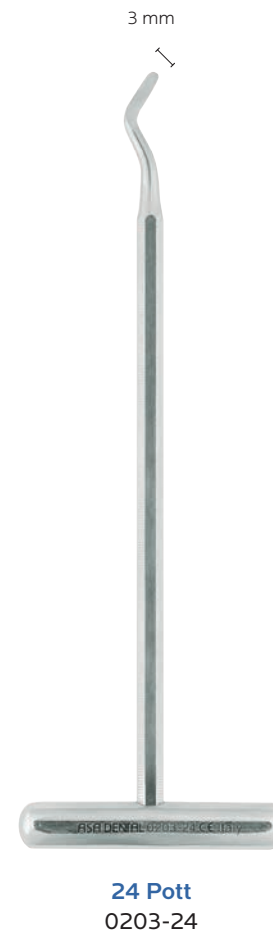

Mini-leve per frammenti di radici con manico in acciaio inox



Mini-leve per frammenti di radici
con manico in acciaio inox

Sindesmotomi con manico in acciaio inox



1 Heidbrink
0290-1



2 Heidbrink
0290-2



3 Heidbrink
0290-3

2,8 mm



1 Warwick-James
0294-1

2 mm



2 Warwick-James
0294-2

2 mm



3 Warwick-James
0294-3



1 Chompret
0295-1



2 Chompret
0295-2



4 Chompret
0295-4



3 Chompret
0295-3



3 Chompret
W0298-3

AsaLady

Sindesmotomi



11 cm
0296-M



0
0296-0

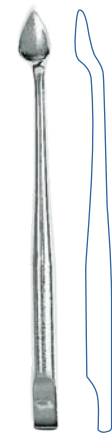

1
0296-1



2
0296-2



3
0296-3



4
0296-4



5
0296-5



6
0296-6



7
0296-7



8
0296-8



9
0296-9

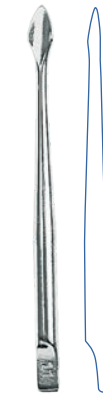

11
0296-11



21
0296-21

Sindesmotomi



0296-22

I sindesmotomi Asa Dental offrono il vantaggio di un'impugnatura ergonomica alla quale applicare, di volta in volta, la punta più adatta per risolvere il caso in esame. Tipicamente utilizzati in modo efficace per preparare il campo ad un'estrazione atraumatica, molti di loro possono essere comodamente utilizzati come periotomi.



22
0296-22



23
0296-23



24
0296-24



25
0296-25



26
0296-26



27
0296-27



28
0296-28



29
0296-29

Dissetto

Periotomi

Kit di Sindesmotomi

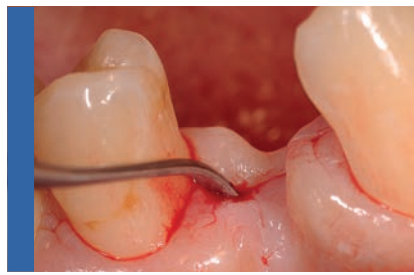

PR1857-1
Utilizzato subito dopo l'incisione del bisturi, questo strumento facilita l'incisione del periostio fino all'esposizione del tessuto osseo.



PR1857-1
Perfection



1
ML1845-1



2
ML1845-2



3
ML1845-3

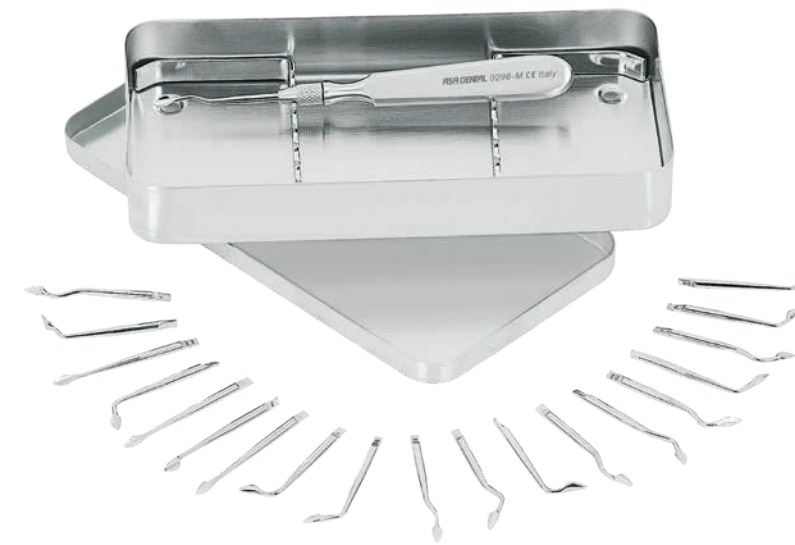

S0296



S0296-1

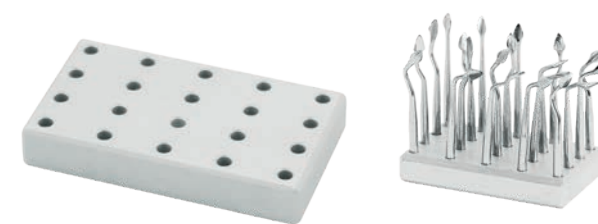

S0297-1

	manico per sindesmotomi	0296-M
0	punta sindesmotomo	0296-0
1	punta sindesmotomo	0296-1
2	punta sindesmotomo	0296-2
3	punta sindesmotomo	0296-3
4	punta sindesmotomo	0296-4
5	punta sindesmotomo	0296-5
6	punta sindesmotomo	0296-6
7	punta sindesmotomo	0296-7
8	punta sindesmotomo	0296-8
9	punta sindesmotomo	0296-9
11	punta sindesmotomo	0296-11
21	punta sindesmotomo	0296-21
22	punta sindesmotomo	0296-22
23	punta sindesmotomo	0296-23
24	punta sindesmotomo	0296-24
25	punta sindesmotomo	0296-25
26	punta sindesmotomo	0296-26
27	punta sindesmotomo	0296-27
28	punta sindesmotomo	0296-28
29	punta sindesmotomo	0296-29
	griglia portastrumenti	2700-G
	base vassoio	2700-L
	coperchio	2700-U

	manico per sindesmotomi	0296-M
0	punta sindesmotomo	0296-0
1	punta sindesmotomo	0296-1
2	punta sindesmotomo	0296-2
3	punta sindesmotomo	0296-3
4	punta sindesmotomo	0296-4
5	punta sindesmotomo	0296-5
6	punta sindesmotomo	0296-6
7	punta sindesmotomo	0296-7
8	punta sindesmotomo	0296-8
9	punta sindesmotomo	0296-9
11	punta sindesmotomo	0296-11
	griglia portastrumenti	2700-G
	base vassoio	2700-L
	coperchio	2700-U

Portapunte per sindesmotomi
20 fori
70x40x12 mm

Kit per chirurgia orale ed estrattiva



Kit chirurgia orale
SPR2781-S

	manico per specchietti	ML2101
5	specchietto doppio	22305
CP-15	sonda millimetrica parodontale	0702L-15
5	manico per bisturi e lama	0350-5
	dissettore	PR1857-1
PR3	scollaperiostio Prichard	MV1851-PR3
	pinzetta chirurgica	PR0625-2
23	collatore Seldin	1855-23
	divaricatore Farabeuf	2616-1
	leve per radici Friedman	0229-2F
	leve per radici Friedman	0229-1F
	leve per radici Mini Friedman	0291-1F
	leve per radici Mini Friedman	0291-2F
85	cucchiaio alveolare Lucas	ML2001-85
87	cucchiaio alveolare Lucas	ML2001-87
88	cucchiaio alveolare Lucas	ML2001-88
2R/2L	strumento parodontale	ML1806-2RL
4R/4L	strumento parodontale	ML1806-4RL
	porta aghi Castroviejo	PR0460-15TC
2TC	forbicine per gengive	0309-2TC
	cassetta portastrumenti	2780-1B

33	pinza per estrazione	0100-33
51A	pinza per estrazione	0100-51A
67A	pinza per estrazione	0100-67A
79	pinza per estrazione	0100-79
1B	leva per radici	0200-1
2F	leva per radici	0201-2
3F	leva per radici	0201-3
320	leva per radici	0202-320
321	leva per radici	0202-321

33	pinza per estrazione	0100-33
51A	pinza per estrazione	0100-51A
67A	pinza per estrazione	0100-67A
79	pinza per estrazione	0100-79
1B	leva per radici	0200-1
2B	leva per radici	0201-2
3B	leva per radici	0201-3
	porta aghi	0435-14TC
	porta aghi	0425-16TC



S0100-3



S0100-4

Accessori

valigia portastrumenti e pinze



9002

1	valigia	9002
2	inserto con elastici per 10 strumenti	9002-2
3	inserto con spazi per 16 strumenti	9002-3
4	inserto per 6 pinze estrattive	9002-1

lubrificanti per la protezione degli strumenti in autoclave

Massima protezione degli strumenti in autoclave. Penetra negli snodi e lubrifica. Protegge e lubrifica gli strumenti chirurgici e dentali prima e dopo la sterilizzazione. Modalità d'uso: oliare prima e dopo la sterilizzazione le punte, gli snodi e le chiusure degli strumenti



Steril Oil
40 ml
8002

Lubrificante speciale per strumenti dentali e chirurgici. Per lubrificare gli snodi di forbici, pinze per estrazione, ossivore, emostatiche, porta aghi, ecc. prima e dopo la sterilizzazione. Non prosciuga durante la sterilizzazione. Protegge dalla corrosione e da altri depositi e cura il buon funzionamento degli strumenti



Silicone
40 ml
8010

CHIRURGIA IMPLANTARE

MADE IN ITALY

IL RECUPERO DELL'ELEMENTO DENTARIO ATTRAVERSO LA CHIRURGIA

L'ultimo decennio è stato caratterizzato dall'ascesa della chirurgia implantare come pratica clinica utilizzata dai dentisti per migliorare la qualità di vita dei loro pazienti. Sebbene l'implantologia possa rivelarsi utile come tecnica alternativa ad altre opzioni di trattamento più convenzionali, ci sono casi in cui rappresenta la scelta obbligata per la risoluzione di problemi funzionali, anatomici o estetici che insorgono in seguito alla perdita di uno o più denti. Asa Dental ha concepito una serie di strumenti estremamente funzionali e facili da utilizzare che aiutano i dentisti qualificati a risolvere efficacemente anche i casi più complessi, per assicurare ai pazienti tutti i vantaggi che offre la terapia implantare, tra i quali l'elevata stabilità, la conservazione della cresta alveolare e la durata nel tempo. Le nostre competenze progettuali e produttive ci hanno permesso di instaurare proficue collaborazioni con i migliori esperti del settore, per formulare una proposta didattica di alto livello, volta all'accrescimento professionale dello specialista.

- E4 Forbicine
- E5 Porta aghi
- E7 Bisturi
- E10 Divaricatori
- E13 Strumenti per il seno
mascellare
- E16 Martelli chirurgici
- E16 Scalpelli chirurgici
- E18 Osteotomi
- E21 Strumenti per osso
e accessori
- E32 Sonde millimetriche
- E32 Depht gauge
- E33 Cannule per aspirazione
- E33 Calibri
- E34 Frese
- E35 Compattatori per osso
- E35 Pinzette
- E38 Kit

Manici

PUNTA SINGOLA

Asa60
(acciaio inox)
ø 6,0 mm



Leonardo ML
(acciaio inox)
ø 7,0 mm



Perfection
(acciaio inox)
ø 8,0 mm



● Magic Color MC
(anima in alluminio e
plastica antiscivolo)
ø 8,0 / 10,5 mm



PUNTA DOPPIA

Asa60
(acciaio inox)
ø 6,0 mm



Asa Light MV
(acciaio inox, vuoto)
ø 8,0 mm



Leonardo ML
(acciaio inox)
ø 7,0 mm



Perfection
(acciaio inox)
ø 8,0 mm



Ottagonale
(acciaio inox)
ø 5,5 mm



● Magic Color MC
(anima in alluminio e
plastica antiscivolo)
ø 8,0 / 10,5 mm



strumento standard



strumento con inserti al carburo di tungsteno (TC)

Come usare le informazioni

- CP-12 → modello + nome scientifico
- MC0702-12 → codice Asa Dental
- Magic Color MC → manico

AsaLady

prodotti ergonomici progettati su misura per le mani femminili:

- manici ridotti e più leggeri
- anelli delle dita più piccoli
- dimensioni ridotte
- codici con prefissi "W" o "SW"

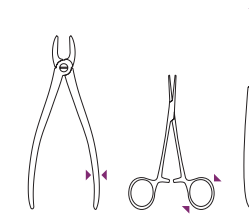

* questi prodotti non sono realizzati da Asa Dental e vengono commercializzati con il marchio del produttore

Forbicine per gengive



1 Goldman-Fox
retta
una lama dentata
13 cm
0304-1



2 Goldman-Fox
curva
una lama dentata
13 cm
0304-2



1TC Kelly
retta
16 cm
0309-1TC



2TC Kelly
curva
16 cm
0309-2TC



1 Metzenbaum-Delikat
retta
14,5 cm
0322-1



2 Metzenbaum-Delikat
curva
14,5 cm
0322-2

forbicine per separare

Porta aghi



TC Mathieu
14 cm
0435-14TC



TC Mathieu
17 cm
0435-17TC



TC Lichtenberg
17 cm
0437-17TC



TC Castroviejo
14 cm
0445-14TC



TC Castroviejo
14 cm
0446-14TC



TC Castroviejo
14 cm / 60°
0448-14TC

Porta aghi

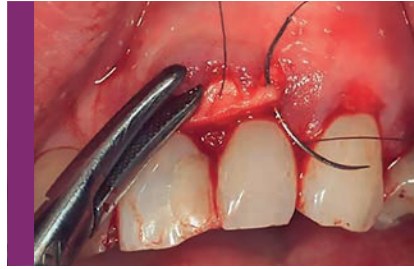

PR0460-15TC
 PORTA AGHI CASTROVIEJO CON PUNTE CURVE
 Facilita al massimo le operazioni di sutura.

Manici per bisturi



TC Castroviejo
 con punte curve
 15,5 cm
 PR0460-15TC



TC Micro-Barraquer
 18 cm
 0450-18TC



TC Micro-Barraquer
 con punte curve
 18 cm
 0451-18TC



3
 13 cm
 0350-3



3
 12 cm
 W0349-3

AsaLady



3G
 13 cm
 0350-3G



8
 13 cm
 0350-8



7
 16 cm
 0350-7

Manici per bisturi



5
14,5 cm
0350-5

5A
14,5 cm
0350-5A

Lame per bisturi *

100 pz / confezione



12D
a doppio taglio
0351-12D



15C
0351-15C



10
0351-10



11
0351-11



12
0351-12



15
0351-15

Micro lame *

25 pz (sterili) / confezione



4
0366-4



7
0366-7

13,5 cm
0365-1

Bisturi a lama orientabile



16 cm
0335-1



16,5 cm
0352



serie composta da 0352 pinza togli lame +
0335-1 manico per bisturi a lama orientabile

Pinza togli lame bisturi



S0352

Bisturi monouso *

10 pz / confezione



0371-11



0371-10



0371-12



0371-15

Divaricatori

divaricatore labiale



23,5 cm
2628-1

divaricatore apribile



25,5 cm
2628-2

Divaricatori



20 cm
2627

divaricatori per labbra



Sternberg
14 cm
2602-1



Orringer medium
11 x 8 cm
2609-2

Divaricatori

divaricatore per guance

divaricatori per spina nasale

Strumenti per rialzo del seno mascellare



University of Minnesota
14 cm
2604



Middeldorpf
21,5 cm
2620-1



21 cm
2625-1



21 cm
2626-1



1
MV1856-1
Asa Light MV

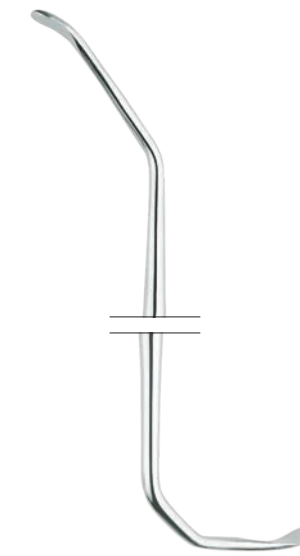

2
MV1856-2
Asa Light MV



3
MV1856-3
Asa Light MV



4
MV1856-4
Asa Light MV



5
MV1856-5
Asa Light MV

Strumenti per rialzo del seno mascellare



6
MV1856-6
Asa Light MV

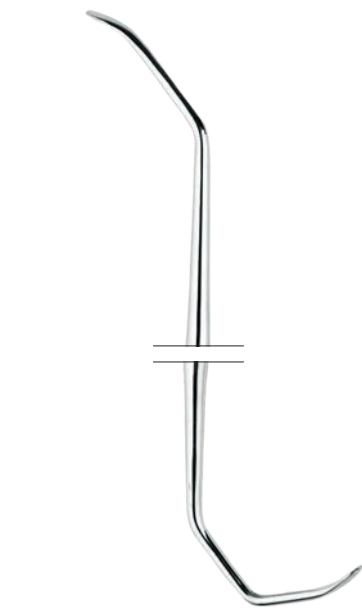

7
MV1856-7
Asa Light MV

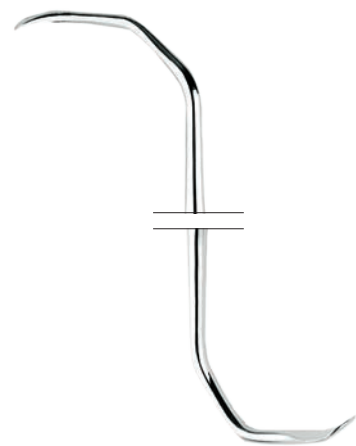

8
MV1856-8
Asa Light MV



1
PR1859-1
Perfection



2
PR1859-2
Perfection



1
MV1855-1
Asa Light MV

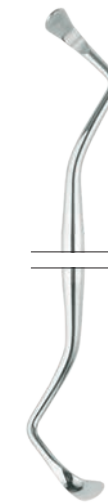

2
MV1855-2
Asa Light MV

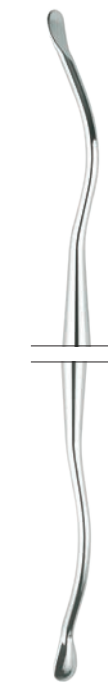

4
MV1855-4
Asa Light MV

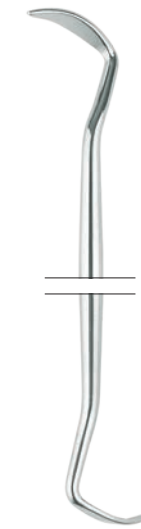

3
MV1855-3
Asa Light MV

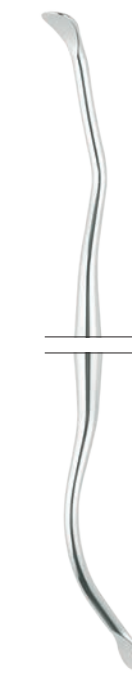

5
MV1855-5
Asa Light MV



6
MV1855-6
Asa Light MV

Martelli chirurgici

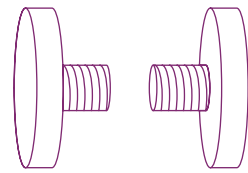

1881-R
coppia inserti di
ricambio in Teflon
autoclavabile max 120°



Partsch
19 cm
1880
con piombo



Mead
19,5 cm
1881

Scalpell Freer taglio singolo

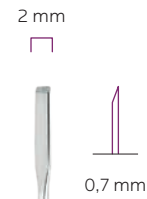

1 Freer
1839-1

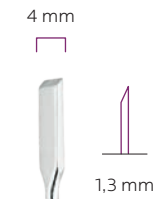

2 Freer
1839-2

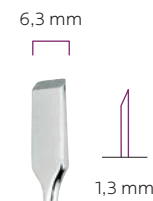

3 Freer
1839-3

Scalpell graduati

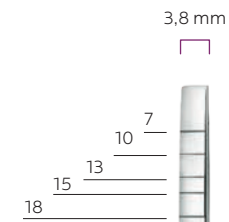

1
retto
1840-1

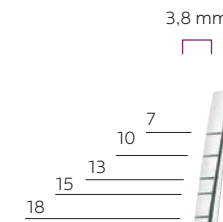

2
curvo
1840-2

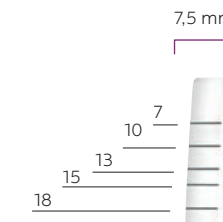

3
retta
1840-3

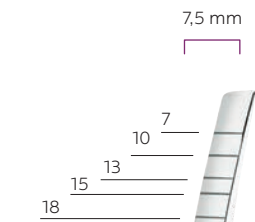

4
curvo
1840-4

1840-1

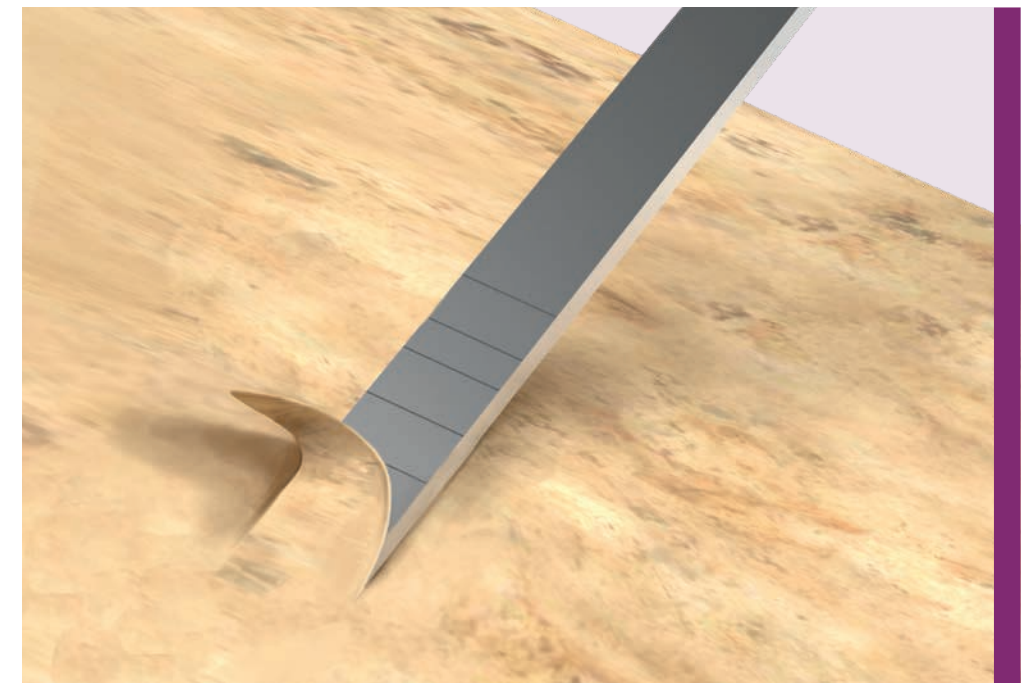





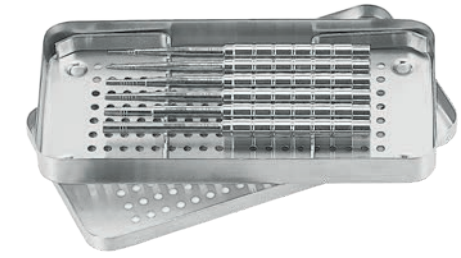





























Osteotomi

Osteotomi



1 · 2 · 3 · 4 · 5 · 6
S0495-6
set da 6
con vassoio S2702

 CONCAVO	 CONCAVO	 CONCAVO	 CONCAVO	 ANGOLARE	 PIATTO
Ø 3 mm	Ø 3,3 mm	Ø 3 mm	Ø 3,3 mm	Ø 3 mm	Ø 3 mm
					
165 mm 0498-1B3	165 mm 0498-1B33	165 mm 0498-2C3	165 mm 0498-2C33	165 mm 0498-30B3	120 mm 0498-PF3
	Ø 4 mm	Ø 4 mm	Ø 3,3 mm	Ø 3,3 mm	Ø 3,3 mm
					
	165 mm 0498-1B4	165 mm 0498-2C4	165 mm 0498-30B33	120 mm 0498-PF33	
	Ø 5 mm	Ø 5 mm	Ø 4 mm	Ø 4 mm	Ø 4 mm
					
	165 mm 0498-1B5	165 mm 0498-2C5	165 mm 0498-30B4	120 mm 0498-PF4	
			Ø 5 mm	Ø 5 mm	Ø 5 mm
					
			165 mm 0498-30B5	120 mm 0498-PF5	

 CONCAVO	 CONCAVO	 CONCAVO	 CONCAVO	 CONCAVO	 CONCAVO
· Ø 1,5 mm	· Ø 1,8 mm	· Ø 2,9 mm	· Ø 3,1 mm	· Ø 4,1 mm	· Ø 5,5 mm
7,5 · Ø 1,6 mm 9 · Ø 1,7 mm 10,5 · Ø 2,2 mm 12 · Ø 2,4 mm 13,2 · Ø 2,5 mm 15,2 · Ø 3,4 mm	7,5 · Ø 2 mm 9 · Ø 2,1 mm 10,5 · Ø 2,9 mm 12 · Ø 3 mm 13,2 · Ø 3,1 mm 15,2 · Ø 3,2 mm	7,5 · Ø 3,1 mm 9 · Ø 3,2 mm 10,5 · Ø 3,3 mm 12 · Ø 3,4 mm 13,2 · Ø 3,4 mm 15,2 · Ø 3,5 mm	7,5 · Ø 3,8 mm 9 · Ø 3,9 mm 10,5 · Ø 4,1 mm 12 · Ø 4,2 mm 13,2 · Ø 4,3 mm 15,2 · Ø 4,6 mm	8,5 · Ø 5 mm 10 · Ø 5 mm 11 · Ø 5 mm	8,5 · Ø 6,2 mm 10 · Ø 6,2 mm 11 · Ø 6,2 mm
					
155 mm 0495-1	155 mm 0495-2	155 mm 0495-3	155 mm 0495-4	155 mm 0495-5	155 mm 0495-6

Osteotomi

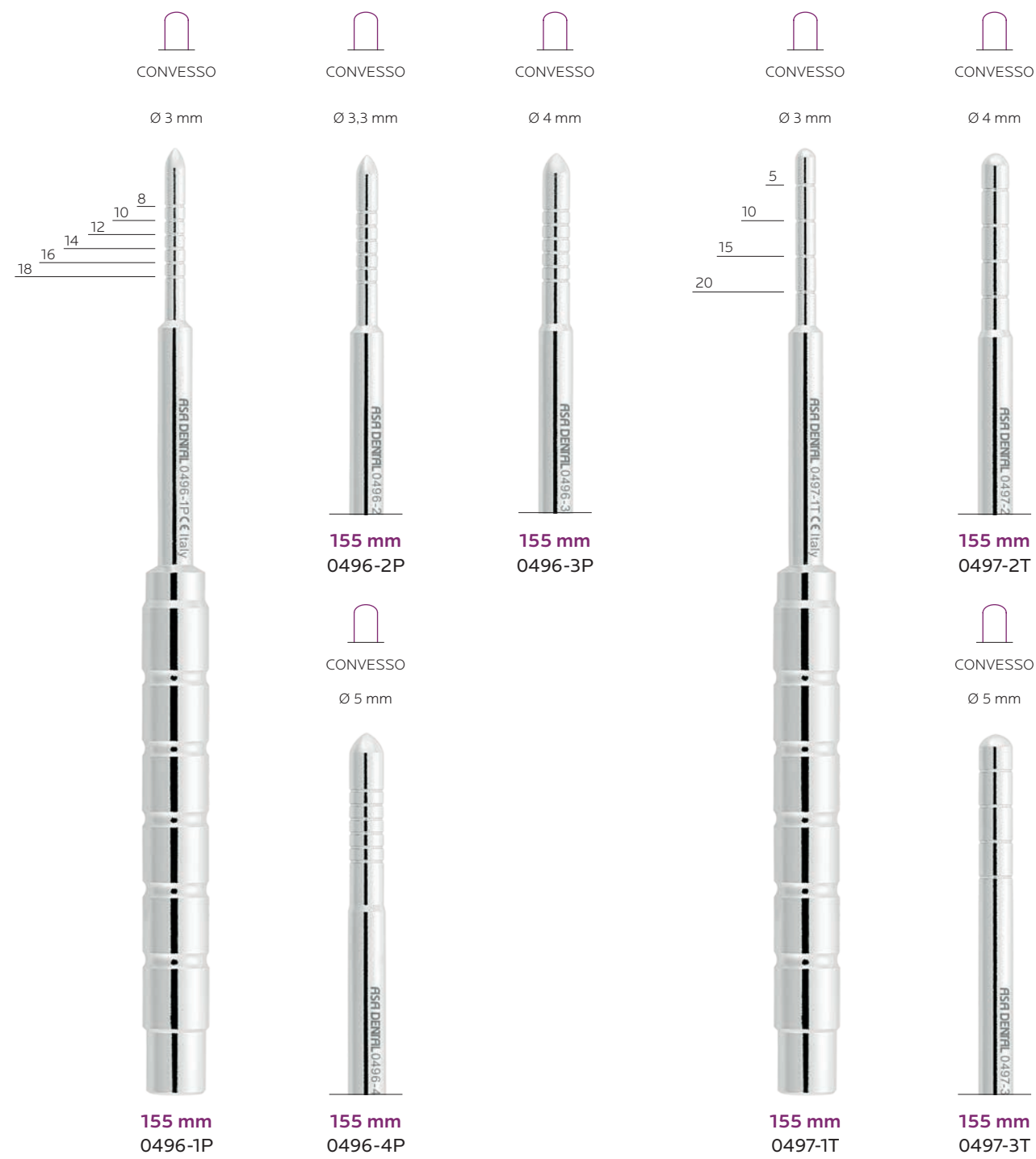

Lime per alveolotomia

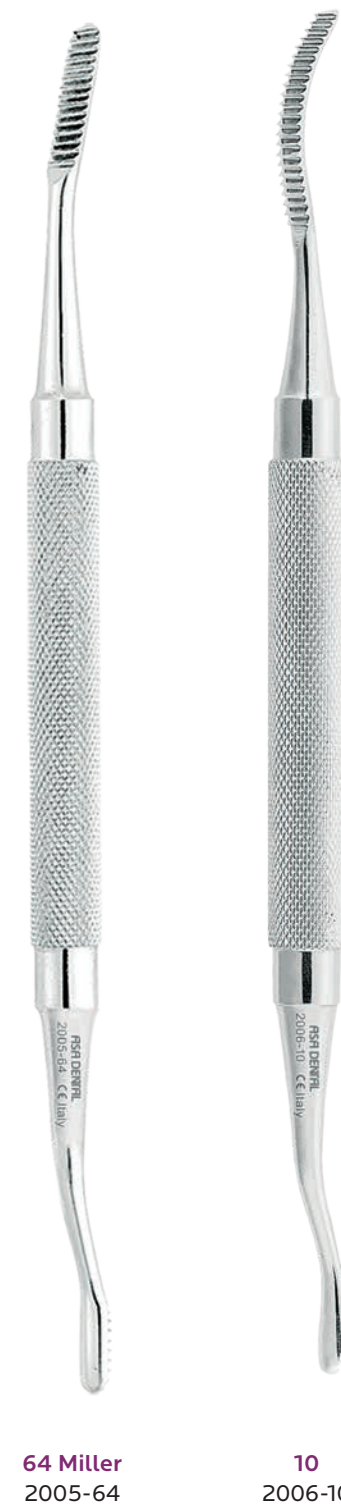

Cucchiai alveolari

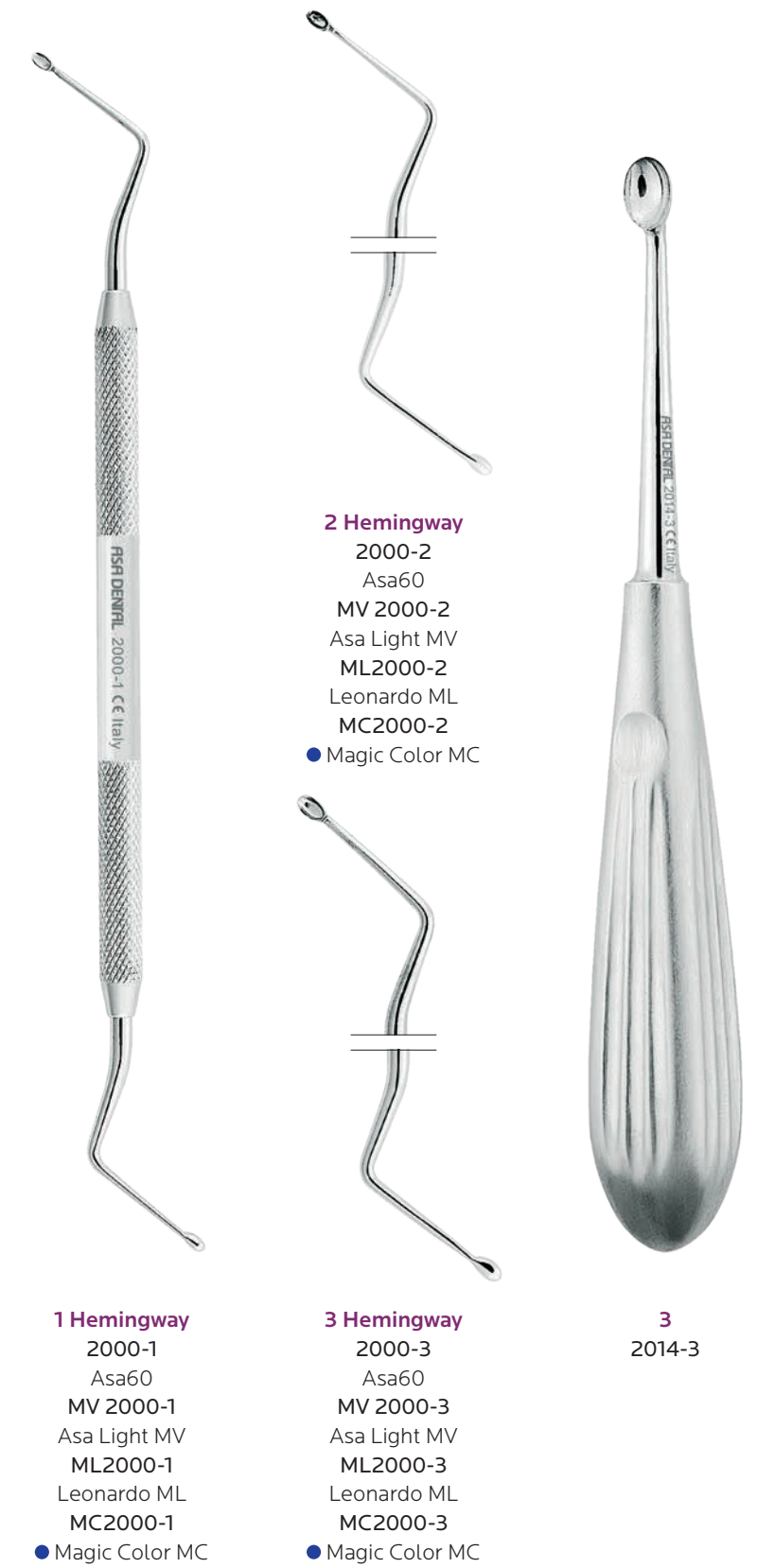

Dissetto

Scollaperiostio

Scollaperiostio

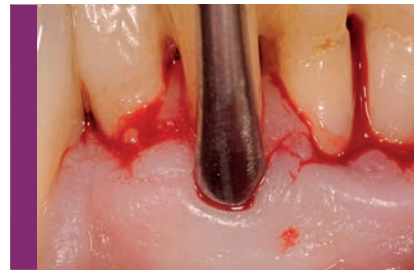

PR1850-M
SCOLLAPERIOSTIO CON PUNTA
ARROTONDATA E PUNTA LANCEOLATA
Consente un efficace scollamento
anche nei margini gengivali più ristretti
e festonati.

3 mm
PUNTA LANCEOLATA



1
PR1857-1
Perfection



3 mm
PUNTA ARROTONDATA

Buser
PR1850-M
Perfection



Beale
5114-1
Ottagonale



GF Goldman-Fox
MV1850-GF
Asa Light MV



9A Allen
MV1850-9A
Asa Light MV



M7 Molt
MV1850-M7
Asa Light MV



M8 Molt
MV1850-M8
Asa Light MV

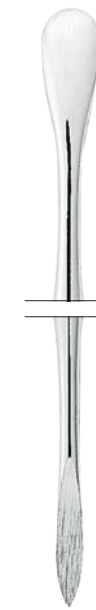

M9 Molt
MV1850-M9
Asa Light MV

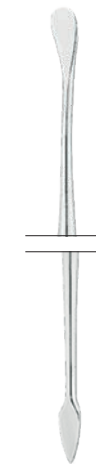

2 Hourigan
MV1851-2
Asa Light MV



PR3 Prichard
MV1851-PR3
Asa Light MV

Scollaperiostio

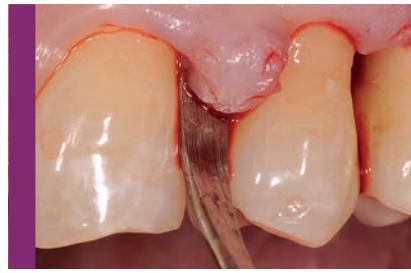

PR1850-1
SCOLLAPAPILLA
Consente lo scollamento e il sollevamento atraumatico della papilla gengivale nelle tecniche di conservazione della papilla.

2 mm

2,5 mm

Scollaperiostio



Parsch
14,5 cm
1849-1
Asa60

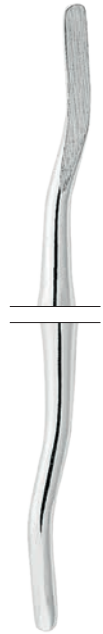

1 Hopkins
MV1852-1
Asa Light MV

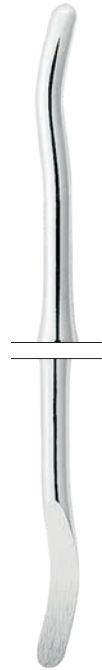

2 Hopkins
MV1852-2
Asa Light MV

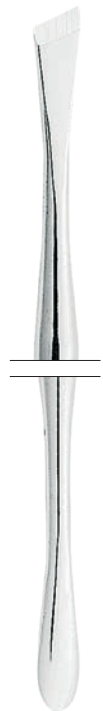

3 Mead
MV1854-3
Asa Light MV

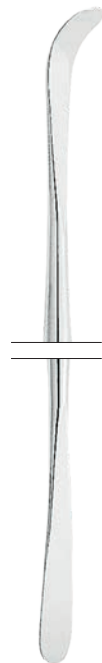

15 Freer
MV1853-15
Asa Light MV

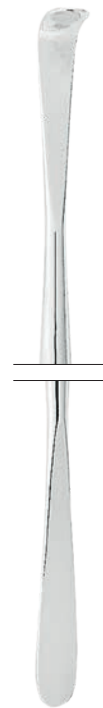

16 Freer
MV1853-16
Asa Light MV



17 cm
PR1850-1
Perfection



22 Seldin
divaricatore
1855-22



23 Seldin
divaricatore
1855-23



König
15,5 cm
1858-1



Williger
17 cm
1856-1



Williger
16 cm
1856-2



Williger
16 cm
1857-1



Williger
13 cm
1857-2

Mucotomi

3 mm



retto
1844-3

4 mm



retto
1844-4

5 mm



retto
1844-5

6 mm



retto
1844-6

3 mm



curvo
1844-3C

4 mm



curvo
1844-4C

5 mm



curvo
1844-5C

6 mm



curvo
1844-6C

Iniettori per osso

Ø 2,5 mm



16 cm
0490-1

Ø 4,5 mm



16 cm
0490-2

Macinatore per osso



17 cm
1846

Raschietti per osso

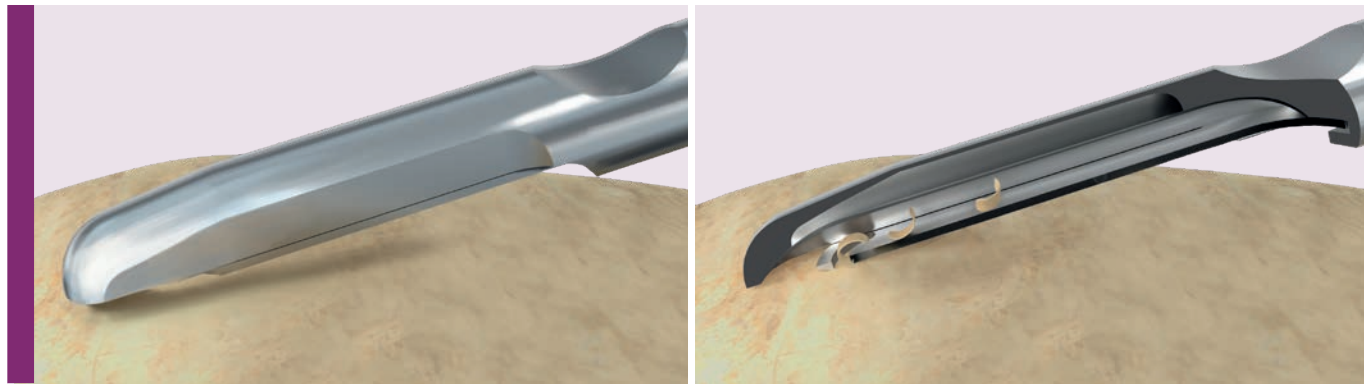

0494-1



retto
15 cm
0494-1
lama inclusa



retto
0494-1R
lama per
0494-1



curvo
15 cm
0494-2
lama inclusa



retto
0494-2R
lama per
0494-2

Periotomi



1
ML1845-1
Leonardo ML

2
ML1845-2
Leonardo ML

3
ML1845-3
Leonardo ML



MV1231-1
Asa Light MV

Applicatore per osso

Pinza per tessuti
dimensioni ridotte per
accesso in aree molto limitate



Goldman-Fox
10 cm
0103-60

Pinze ossivore alveolotome

Spessimetro per osso

Posizionatore di membrane



Luer
15 cm
0103-10



Mini Friedman
12 cm
0103-25



Blumenthal
15 cm
0103-30



Blumenthal
14,5 cm
0103-31

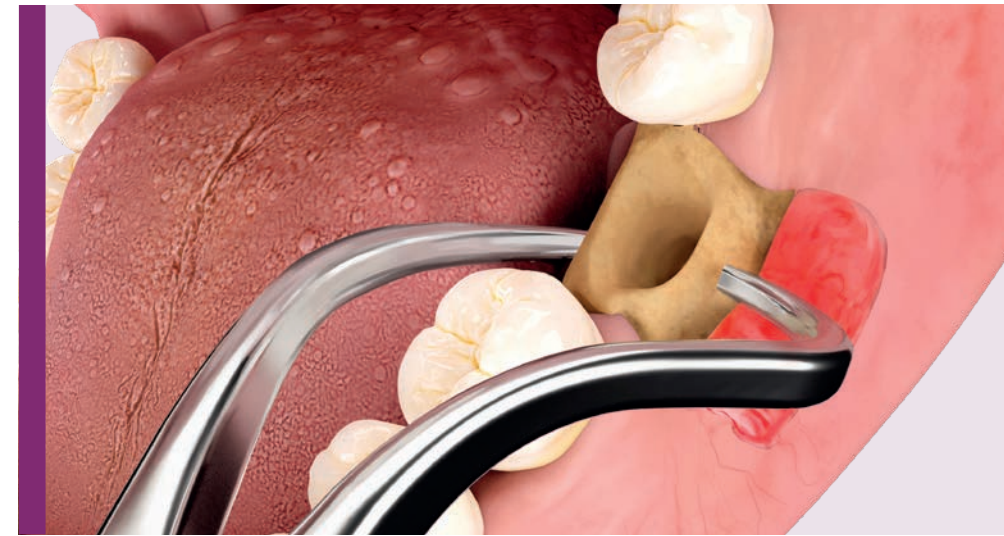

0491-2



17,5 cm
0491-1



15,5 cm
0491-2



Buser
MV1883
Asa Light MV

Mortaio per osso



h. 3 cm
1030-4

Sonde millimetriche



CP-11
0702L-11
Asa60



CP-12
0702L-12
Asa60
MC0702-12
● Magic Color MC



CP-12S
0702L-12S
Asa60

Misuratore di profondità



ML0804-1

Cannule per aspirazione
filtri per osso

cannula aspirativa
filtro recupero osso
autoclavabile



16,5 cm
0493-1

Filtro di ricambio
a maglia media
per 0493-1



2,7 cm
0493-2



filtro in acciaio per osso
da collegare alla cannula
aspirativa monouso



0493-5

Calibro

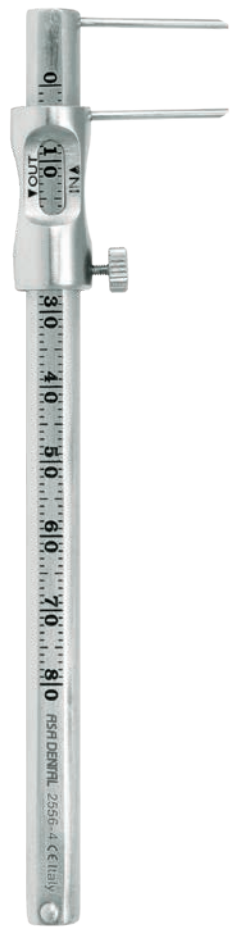

2556-4

Frese carotatrici Trepchine con punte millimtrate *

Ø interno 2,8 mm



1841-1

Ø interno 5,0 mm



1841-2

Ø interno 7,0 mm



1841-3

Ø interno 10,0 mm



1841-4

Porta frese

alluminio, sterilizzabile in autoclave a vapore saturo

con bordo 24 fori CA (grandi)



AL2760-2

con bordo 24 fori FG/CA (piccoli/grandi)



AL2760-3

48 fori CA (grandi)



AL2762-2

silicone colorato con coperchio in plastica

coperchio non autoclavabile



AL2761-U

autoclavabile silicone alimentare atossico

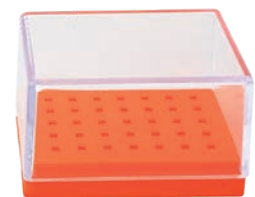

Arancio
S2760-A

autoclavabile silicone alimentare atossico

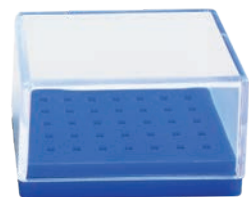

Blu
S2760-C

Compattatori per osso



1
MV1230-1

2
MV1230-2

Pinzette per marcare le tasche



1 (Crane-Kaplan)
Goldman-Fox
15 cm
0650-1

2 (Crane-Kaplan)
Goldman-Fox
15 cm
0650-2

Pinzette chirurgiche

pinzette per sutura

Pinzette per membrana

Pinzette porta impianti



1
Adson
12 cm
0620-1



1
Adson 1x2
12 cm
0621-1



1
Semken-Taylor
12,5 cm
0630-1



2
Semken-Taylor
12,5 cm
0630-2



0,16 mm

16 cm
PR0625-2



0,13 mm

17 cm
PR0625-3



10,5 cm
0660-1



9 cm
0660-2
con punte ad anello



16,5 cm
0661-1



14,5 cm
0661-2



14,5 cm
0661-3

Strumenti per chirurgia implantare

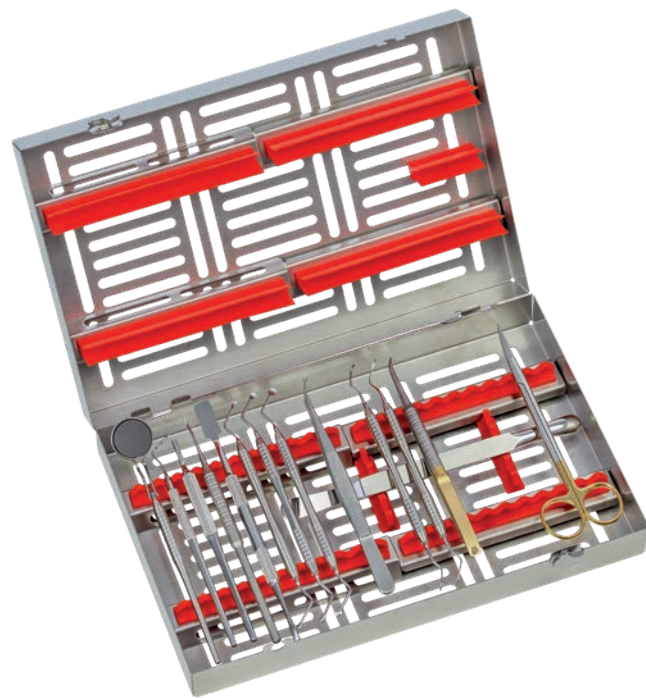

Kit chirurgia implantare
SPR2781-I

	manico per specchietti	ML2101
5	specchietto doppio	22305
CP-15	sonda millimetrica parodontale	0702L-15
5	manico per bisturi e lama	0350-5
	dissetto	PR1857-1
PR3	scollaperiostio Prichard	MV1851-PR3
23	divaricatore Seldin	1855-23
85	cucchiaio alveolare Lucas	ML2001-85
87	cucchiaio alveolare Lucas	ML2001-87
88	cucchiaio alveolare Lucas	ML2001-88
	pinzetta chirurgica	PR0625-2
2R/2L	strumento parodontale	ML1806-2RL
4R/4L	strumento parodontale	ML1806-4RL
	porta aghi Castroviejo	PR0460-15TC
2TC	forbicina per gengive	0309-2TC
	cassetta portastrumenti	2780-1R

Strumenti per chirurgia implantare



Kit mini rialzo del seno
SPR0495

	osteotomo	0495-1
	osteotomo	0495-2
	osteotomo	0495-3
	osteotomo	0495-4
	osteotomo	0495-5
	osteotomo	0495-6
	martello Mead	1881
	cassetta portastrumenti	2770-1R

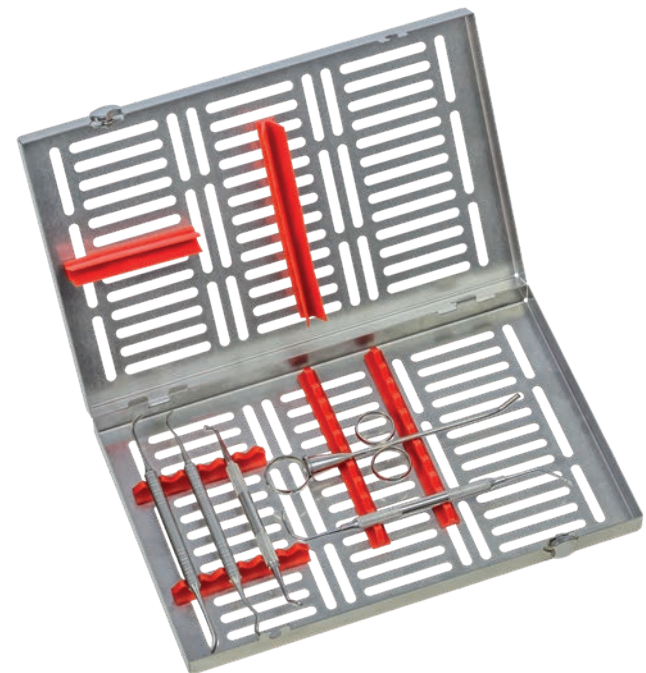

Kit grande rialzo del seno
SPR0496

	strumento per il seno mascellare	PR1859-1
	strumento per il seno mascellare	PR1859-2
	applicatore per osso	MV1231-1
	iniettore per osso	0490-1
2	strumento per il seno mascellare	MV1856-2
	cassetta portastrumenti	2770-3R



288 x 182 x h. 60 mm
S2780-IMP

	mortaiolo per osso	1030-4
	macinatore per osso	1846
3	cucchiaio alveolare	2014-3
	raschietto per osso retto	0494-1
	iniettore per osso	0490-2
	iniettore per osso	0490-1
1	compattatore per osso	MV1230-1
2	compattatore per osso	MV1230-2

Strumenti per chirurgia implantare

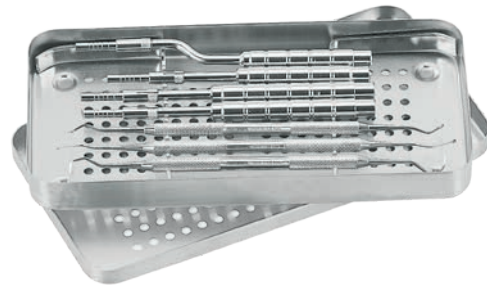

Kit mini rialzo del seno
S0498-8

1B4	osteotomo concavo	0498-1B4
2C4	osteotomo concavo	0498-2C4
30B4	osteotomo angolare	0498-30B4
PF4	osteotomo piatto	0498-PF4
U15/30	scaler Towner-Jacquette	1902-2
1	scaler universale Goldman-Fox	1809-1
31/32	curette Jacquette	1831-32
87	cucchiaio alveolare Lucas	2001-87
	vassoio	S2702

Strumenti per chirurgia implantare

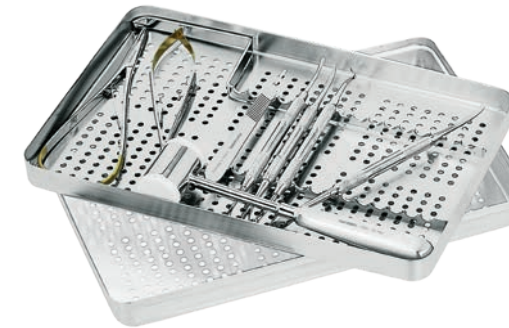

S3003-9

M9	scollaperiostio Molt	MV1850-M9
PR3	scollaperiostio Prichard	MV1851-PR3
GF	scollaperiostio Goldman-Fox	MV1850-GF
15K/16K	bisturi Kirkland	MV1803-D
	martello Mead	1881
	Porta aghi Castroviejo	0446-14TC
	Porta aghi Mathieu	0435-17TC
3	manico per bisturi	0350-3
	vassoio	S2722-1



kit Goracci
S3001-20

	forbicina per gengive retta	0300-1
	pinzetta per medicazione Flagg	0601-1
23/17A	sonda doppia	0704-23D2
2	spatola doppia per cemento	0903-2
2	spatola Heidemann	1101-2
2	otturatore doppio	1200-2
1L	otturatore doppio	1202-1L
2L	otturatore doppio	1202-2L
1T	otturatore Tanner	1211-1T
	applicatore per sottofondo	1301
1/2	strumento per modellare hollenback	1500-02
1	cleoide-discoide	1600-1
26	finitore per bordi gengivali	1601-1
27	finitore per bordi gengivali	1601-2
1	escavatore doppio	1700-1
2	escavatore doppio	1700-2
3	escavatore doppio	1700-3
4	escavatore doppio	1700-4
	manico per specchietto	2102-IN
5	specchietto piano	2200-5
	vassoio	S2721-2



S3003-11

3	manico per bisturi	0350-3
	divaricatore Sternberg	2602-1
2	forbicine Goldman-Fox	0304-2
M9	scollaperiostio Molt	MV1850-M9
PR3	scollaperiostio Prichard	MV1851-PR3
	porta aghi Crile-Wood	0415-15TC
1	pinzetta chirurgica Semken Taylor	0631-1
23	sonda	0700-23
	manico per specchietto	2102-IN
5	specchietto piano	2200-5
11	lame per bisturi (100 pz)	0351-11
	vassoio	S2722-1



CONSERVATIVA

MADE IN ITALY

MAKE PEOPLE SMILE

Questa l'idea, semplice e potente, che guida ogni nostra decisione. Ogni volta che scegliamo i materiali, le tecnologie, le forme e i processi produttivi ci assicuriamo che aiutino i professionisti del settore dentale a far sorridere le persone in ogni angolo del mondo. I nostri strumenti per l'odontoiatria conservativa sono il risultato di un modus operandi ponderato, preciso e funzionale, condotto da esperti del settore attraverso tecnologie avanzate. È così che produciamo escavatori resistenti, rifinitori precisi, brunitori efficaci, strumenti per isolamento innovativi e tutti gli altri prodotti che consentono ai medici di garantire risultati esteticamente impeccabili e funzionalmente superiori.

- F2 Diga Vision
- F4 Uncini per diga
- F8 Strumenti per diga
- F13 Escavatori
- F18 Strumenti da smalto
- F20 Mortai per amalgama
- F20 Spingi amalgama
- F22 Spatole
- F25 Otturatori
- F36 Strumenti per modellare
- F39 Strumenti operativi
- F40 Strumenti per corone
- F44 Pinze emostatiche
- F45 Forbicine
- F46 Matrici
- F48 Strumenti per composito



Vision® Shade

diga dentale

pack 60 dighe di gomma
(colore nero, profumo menta)



VS3045

telaio per diga in acciaio inox
100x150 mm

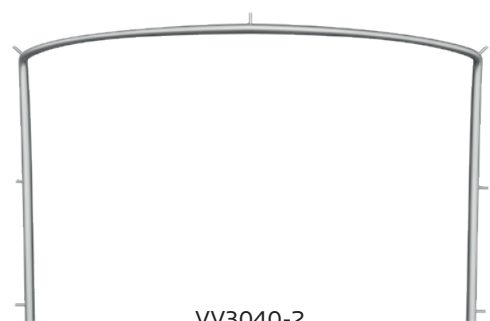

VV3040-2

vassoio magnetico in acciaio inox



VV2731-6

vassoio magnetico in acciaio inox
con 6 uncini



SVS2731-6

uncini



210
con alette
ideale per denti anteriori
VS3051-210



2
con alette
per premolari inferiori / superiori
VS3052-2



12A
con alette, dentellato
per molari inferiori destri/superiori sinistri
VS3052-12A



13A
con alette, dentellato
per molari inferiori sinistri/anteriori destri
VS3052-13A



W4
senza alette
per molari superiori/inferiori
VS3052-W4



W8
senza alette
per molari superiori/inferiori
VS3052-W8

pinza per uncini in acciaio inox

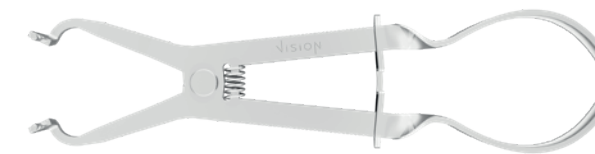

VV3030

pinza foradiga in acciaio inox



VV3033

dima di foratura in acciaio inox

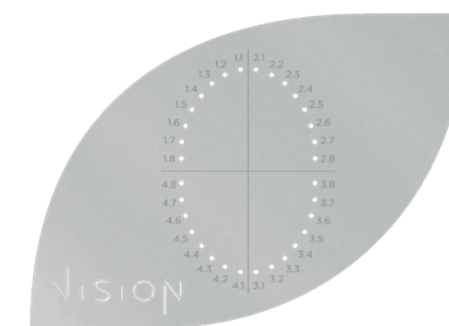

VV3035

pennarello per uso alimentare

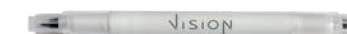

VVPEN

kit Vision Shade



SVS3000

Numerazione dei denti

Denti mascellari	forme
18 17 16	4 W4 8 W8 8A W8A 12A 14 14T W14 14A W14A 26 51 205 202
15 14	0 W0 1 1T W1 2A 2AT W2A 29
13 12 11 21 22 23	9 9T 212 210
24 25	0 W0 1 1T W1 2A 2AT W2A 29
26 27 28	4 W4 8 W8 8A W8A 13A 14 14T W14 14A W14A 26 51
Denti mandibolari	forme
38 37 36	3 W3 7 W7 8A W8A 13A 14 14T W14 14A W14A
35 34	0 W0 2A 2AT W2A 2 2T W2 29
33 32 31 41 42 43	00 9 9T 212 210
44 45	0 W0 2 2T W2 2A -2AT W2A 29
46 47 48	3 W3 7 W7 12A 14 14T W14 14A W14A

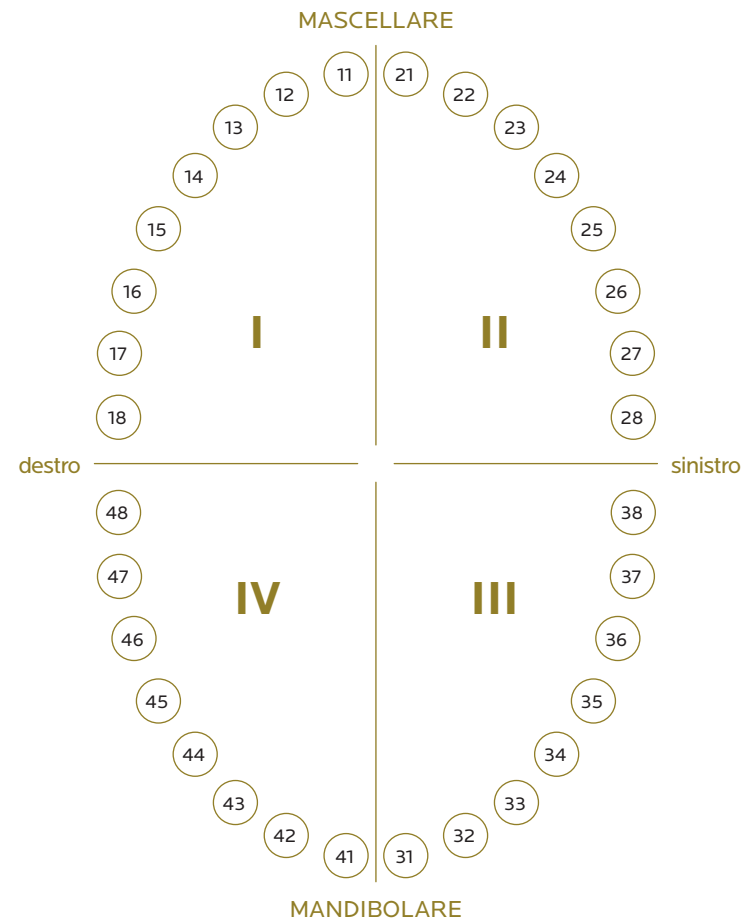

Classificazione

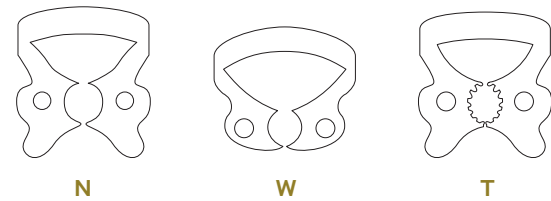

- N** = Standard (uncino con alette)
- W** = Wingless (uncino senza alette)
- T** = Tiger (uncino con branche dentellate)

Uncini per diga

ANTERIORI

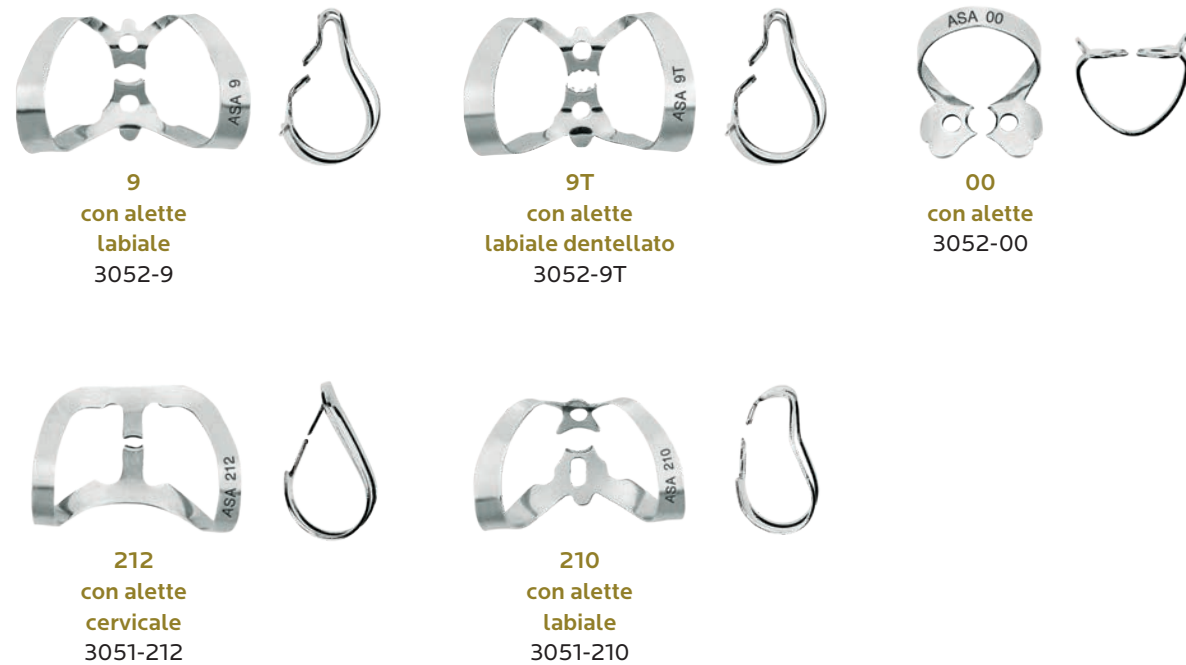

PREMOLARI

per denti di piccole dimensioni, allungati o stretti



0
con alette
3052-0

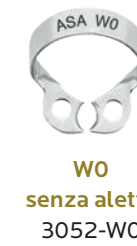

W0
senza alette
3052-W0



per uso generale, con alette adattabili alle curvature delle linee gengivali



1
con alette
3052-1



1T
con alette, dentellato
3052-1T



W1
senza alette
3052-W1



per premolari, con colletto lungo



2A
con alette
3052-2A



2AT
con alette, dentellato
3052-2AT



W2A
senza alette
3052-W2A



per premolari inferiori versatili



2
con alette
3052-2



2T
con alette, dentellato
3052-2T



W2
senza alette
3052-W2



principalmente per premolari mandibolari



29
senza alette
3051-29



60
senza alette
3050-60



MOLARI

per molari inferiori piccoli



3
con alette
3052-3



W3
senza alette
3052-W3



per molari inferiori di forma quadrata



7
con alette
3052-7



W7
senza alette
3052-W7



per radici di molari



8A
con alette
3052-8A



W8A
senza alette
3052-W8A



Per molari tondi, parzialmente rotti, sottodimensionati o inclinati



14
con alette
3052-14



14T
con alette, dentellato
3052-14T



W14
senza alette
3052-W14



per molari superiori



26
senza alette
3051-26



51
senza alette
3051-51

MOLARI

per molari piccoli con colletti tondi



4
con alette
3052-4



W4
senza alette
3052-W4



per molari superiori a forma tonda



8
con alette
3052-8



W8
senza alette
3052-W8



per molari parzialmente rotti



12A
con alette, dentellato
3052-12A



13A
con alette, dentellato
3052-13A



per molari grandi, parzialmente rotti, di forma irregolare o inclinati



14A
con alette
3052-14A



W14A
senza alette
3052-W14A



per molari grandi superiori



202
con alette
3051-202



205
con alette
3051-205

Strumenti per diga

AsaLady

prodotti ergonomici progettati su misura per le mani femminili:

- manici ridotti e più leggeri
- anelli delle dita più piccoli
- dimensioni ridotte
- codici con prefissi "W" o "SW"

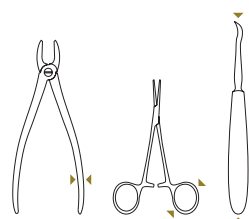

diga in lattice
confezionata in sottovuoto
36 pz / confezione

15x15 cm (6"x 6")
3045

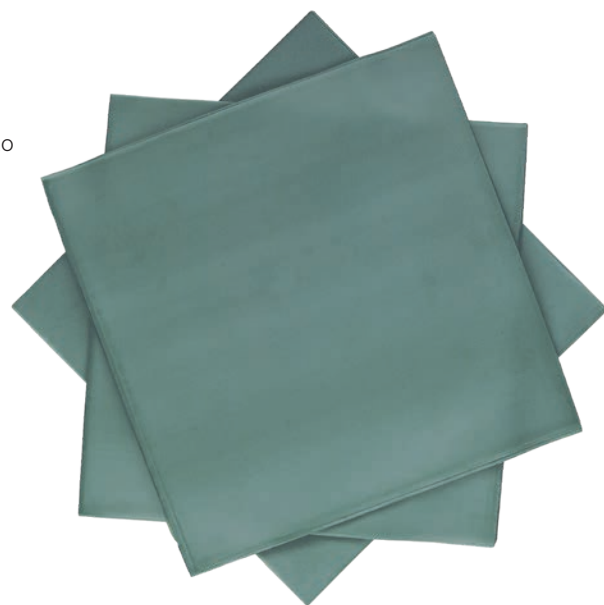

pinza foradiga



Ainsworth
17 cm
3032



Ainsworth
17 cm
W3036



Ivory
16,2 cm
3033

Strumenti per diga



Diga inserita
su molare superiore

telaio per diga
acciaio inox

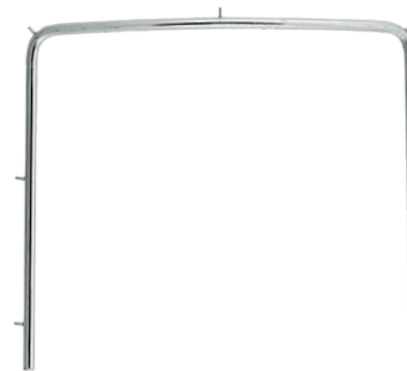

10x10 cm
3040-1

telaio per diga
plastica
sterilizzabile
compatibile con
esame radiografico



3041-1

pinze per uncini



Ivory leggera
17 cm
3030



Ivory leggera
16 cm
W3035



Brewer
17,5 cm
3031

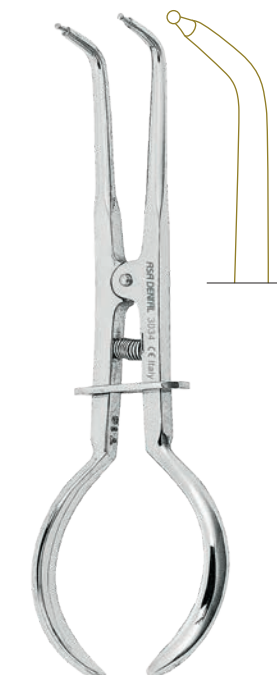

Stoke
17,5 cm
3034

Kit di strumenti per diga



S3000

Set di strumenti per diga realizzato secondo le indicazioni del Prof. GUIDO GORACCI, titolare della Cattedra di Odontoiatria Conservatrice presso l'Università degli Studi di Roma "LA SAPIENZA"

telaio per diga in acciaio inox	3040-1
pinza per uncini Brewer	3031
pinza foradiga Ivory	3033
60 uncino senza alette per premolari	3050-60
26 uncino senza alette per molari	3051-26
51 uncino senza alette per molari	3051-51
29 uncino senza alette per premolari	3051-29
202 uncino con alette per molari	3051-202
205 uncino con alette per molari	3051-205
212 uncino cervicale con alette	3051-212
210 uncino labiale con alette	3051-210
vassoio porta uncini in acciaio inox	2731-1
vassoio in acciaio inox	2720-L
coperchio in acciaio inox	2720-U
griglia portastrumenti in acciaio inox	2730-3

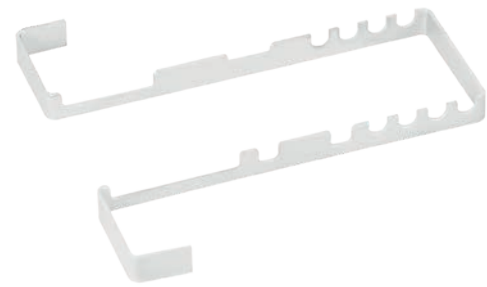

2730-3

griglia porta strumenti per diga

Kit di strumenti per diga



S2731-1

vassoio porta uncini in acciaio inox completo di 8 uncini

60	uncino senza alette per premolari	3050-60
26	uncino senza alette per molari	3051-26
51	uncino senza alette per molari	3051-51
29	uncino senza alette per premolari	3051-29
202	uncino con alette per molari	3051-202
205	uncino con alette per molari	3051-205
212	uncino cervicale con alette	3051-212
210	uncino labiale con alette	3051-210
	vassoio porta uncini in acciaio inox	2731-1



S2731-12

vassoio porta uncini in acciaio inox completo di 12 uncini

212	uncino cervicale con alette	3051-212
00	uncino con alette per premolari	3052-00
0	uncino con alette per premolari	3052-0
1	uncino con alette per premolari	3052-1
2A	uncino con alette per premolari	3052-2A
3	uncino con alette per molari	3052-3
7	uncino con alette per molari	3052-7
8	uncino con alette per molari	3052-8
8A	uncino con alette per radici di molari	3052-8A
12A	uncino dentellato con alette per molari	3052-12A
13A	uncino dentellato con alette per molari	3052-13A
14	uncino con alette per molari	3052-14
	vassoio porta uncini in acciaio inox	2731-1



2731-1

vassoio porta uncini in acciaio inox (senza uncini)

Manici

PUNTA SINGOLA

Asa35
(acciaio inox)
ø 3,5 mm



Asa60
(acciaio inox)
ø 6,0 mm



Ottagonale
(acciaio inox)
ø 5,5 mm



PUNTA DOPPIA

Asa60
(acciaio inox)
ø 6,0 mm



Asa Light MV
(acciaio inox, vuoto)
ø 8,0 mm



Leonardo ML
(acciaio inox)
ø 7,0 mm



Ottagonale
(acciaio inox)
ø 5,5 mm



● Alu60
(aluminum)
ø 6,0 mm



● Alu80
(aluminum, vuoto)
ø 8,0 mm



● Magic Color MC
(anima in alluminio e
plastica antiscivolo)
ø 8,0 / 10,5 mm



Come usare le informazioni

- 1/2 Wedelstaedt → modello + nome scientifico
- MV1604-02 → codice Asa Dental
- Asa Light MV → manico

AsaLady

prodotti ergonomici progettati su misura per le mani femminili:

- manici ridotti e più leggeri
- anelli delle dita più piccoli
- dimensioni ridotte
- codici con prefissi "W" o "SW"

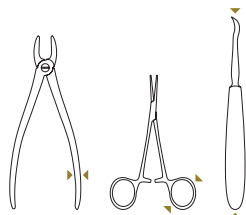

vista dall'alto



vista laterale



vista frontale

Escavatori - cucchiari

set da 5

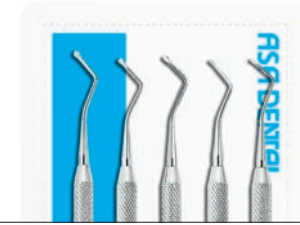

0 · 1 · 2 · 3 · 4
S1700
Asa60
SMV1700
Asa Light MV

0
S1700-0
Asa60

2
S1700-2
Asa60

1
S1700-1
Asa60

3
S1700-3
Asa60

4
S1700-4
Asa60

0,8 mm



0
1700-0
Asa60
MV1700-0
Asa Light MV

1,2 mm



1
1700-1
Asa60
MV1700-1
Asa Light MV
MC1700-1
● Magic Color MC

1,4 mm

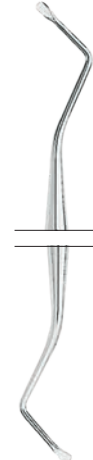

2
1700-2
Asa60
MV1700-2
Asa Light MV
MC1700-2
● Magic Color MC

1,5 mm

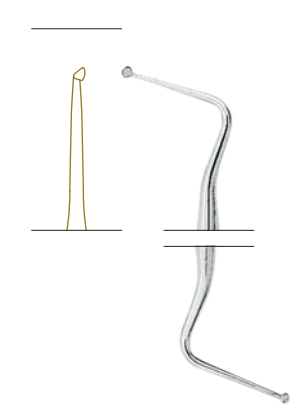

1
1701-1
Asa60
MV1701-1
Asa Light MV

1,6 mm

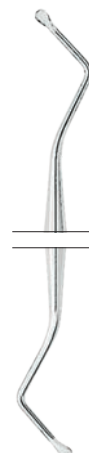

3
1700-3
Asa60
MV1700-3
Asa Light MV
MC1700-3
● Magic Color MC

2 mm

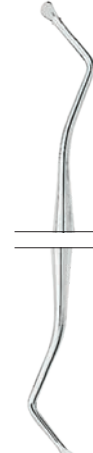

4
1700-4
Asa60
MV1700-4
Asa Light MV

2 mm

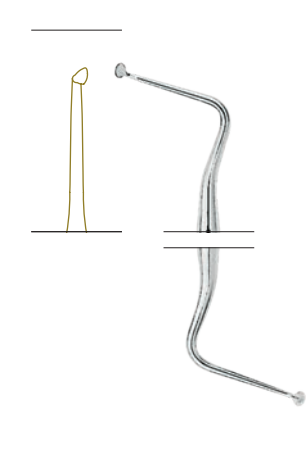

2
1701-2
Asa60
MV1701-2
Asa Light MV

Escavatori - cucchiali

Escavatori - cucchiai ovali

Escavatori - ASH

1,2 mm



6
1702-6
Asa60
MV1702-6
Asa Light MV

1,5 mm

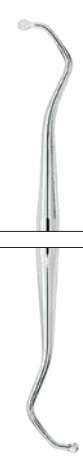

14
1703-14
Asa60
MV1703-14
Asa Light MV
MC1703-14
● Magic Color MC

2,2 mm

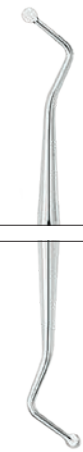

19
1706-19
Asa60
MV1706-19
Asa Light MV

1,2 mm

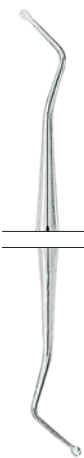

17
1704-17
Asa60
MV1704-17
Asa Light MV
MC1704-17
● Magic Color MC

1,2 mm

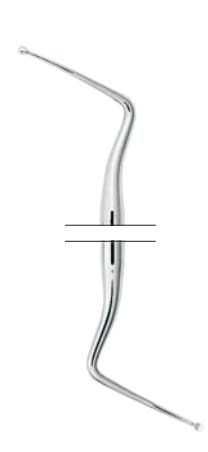

31L
1709-31L
Asa60
MV1709-31L
Asa Light MV

1,5 mm



18
1705-18
Asa60
MV1705-18
Asa Light MV

1,5 mm

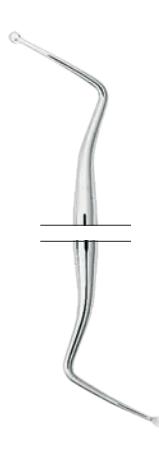

32L
1709-32L
Asa60
MV1709-32L
Asa Light MV

1,2 mm



38/39
1707-39
Asa60
MV1707-39
Asa Light MV

2 mm



33L
1709-33L
Asa60
MV1709-33L
Asa Light MV

1,2 mm



17W
1704-17W
Asa60
MV1704-17W
Asa Light MV

1,5 mm



18W
1705-18W
Asa60
MV1705-18W
Asa Light MV

2 mm



19W
1706-19W
Asa60
MV1706-19W
Asa Light MV

1 mm



243
1711-243
Asa60
ML1711-243
Leonardo ML

1,4 mm



G2
1711-G2
Asa60
ML1711-G2
Leonardo ML

Escavatori - modello SS. White

set da 6



5 · 14 · 17 · 18 · 19 · 20
S1710-6
Asa60

1 mm	1,2 mm	1 mm	2 mm
5 1710-5 Asa60 ML1710-5 Leonardo ML	14 1710-14 Asa60 ML1710-14 Leonardo ML	17 1710-17 Asa60 ML1710-17 Leonardo ML	
	1,2 mm	1,6 mm	
	18 1710-18 Asa60 ML1710-18 Leonardo ML	19 1710-19 Asa60 ML1710-19 Leonardo ML	20 1710-20 Asa60 ML1710-20 Leonardo ML

Escavatori - Darby-Perry

0,8 mm	0,8 mm	1 mm	1 mm	1 mm	2 mm
1 Darby-Perry 1711-1 Asa60 ML1711-1 Leonardo ML	2 Darby-Perry 1711-2 Asa60 ML1711-2 Leonardo ML	11 Darby-Perry 1711-11 Asa60 ML1711-11 Leonardo ML	12 Darby-Perry 1711-12 Asa60 ML1711-12 Leonardo ML	21 Darby-Perry 1711-21 Asa60 ML1711-21 Leonardo ML	
	1,2 mm	1,6 mm	1,6 mm	2 mm	
	22 Darby-Perry 1711-22 Asa60 ML1711-22 Leonardo ML	31 Darby-Perry 1711-31 Asa60 ML1711-31 Leonardo ML	32 Darby-Perry 1711-32 Asa60 ML1711-32 Leonardo ML	41 Darby-Perry 1711-41 Asa60 ML1711-41 Leonardo ML	42 Darby-Perry 1711-42 Asa60 ML1711-42 Leonardo ML

Strumenti da smalto - finitori per bordi gengivali

Strumenti da smalto
scalpelli

Strumenti da smalto
preparazione cavità



1 Black/26
distale
1601-1
Asa60
MV1601-1
Asa Light MV

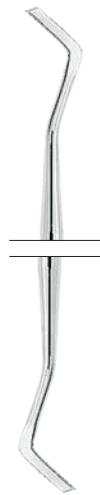

2 Black/27
mesiale
1601-2
Asa60
MV1601-2
Asa Light MV

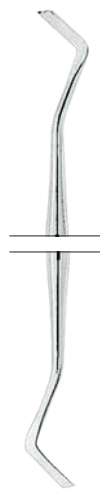

4 Black/29
mesiale
1601-4
Asa60
MV1601-4
Asa Light MV

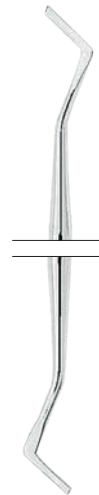

3 Black/28
distale
1601-3
Asa60
MV1601-3
Asa Light MV



1 Black/77-78
distale
1602-1
Asa60
MV1602-1
Asa Light MV



2 Black/79-80
mesiale
1602-2
Asa60
MV1602-2
Asa Light MV



1 Black/53-54
1603-1
Asa60
MV1603-1
Asa Light MV



2 Black/51-52
1603-2
Asa60
MV1603-2
Asa Light MV



1/2 Wedelstaedt
1604-02
Asa60
MV1604-02
Asa Light MV



3/4 Wedelstaedt
1604-04
Asa60
MV1604-04
Asa Light MV



5/6 Wedelstaedt
1604-06
Asa60
MV1604-06
Asa Light MV

Spingi amalgama

Ø 1,5 mm



medium/large
20 cm
1015-2

Ø 2,5 mm

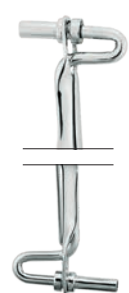

medium
15,5 cm
1011-2

Ø 2 mm



small
15,5 cm
1011-1

Ø 3 mm

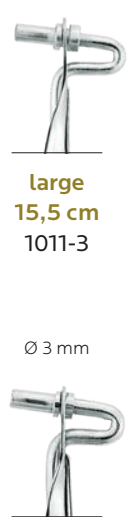

jumbo
15,5 cm
1011-4

Ø 2 mm



medium/small
20 cm
1015-1

Ø 3 mm



large
15,5 cm
1011-3

Ø 2 mm

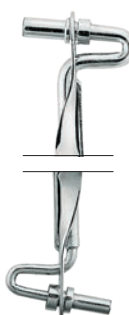

medium/jumbo
20 cm
1015-3

Mortai per amalgama

solo sterilizzazione a freddo



Ø 3,5 cm
h. 3,5 cm
1030-1



Ø 2 cm
h. 4 cm
1030-2



Ø 2 cm
h. 2,5 cm
1030-3

Spingi amalgama

Ø 2 mm



retto
15 cm
1020-1

Ø 2 mm



45°
15 cm
1020-2

Ø 2 mm



90°
15 cm
1020-3

Ø 2 mm



punta in metallo
per 1020-1-2-3
1020-2P

Ø 1,2 mm



curva
per retrograde
13 cm
1009-2

Ø 1,8 mm



retto
per retrograde
13 cm
1009-3

Ø 1,2 mm



retto
per retrograde
13 cm
1009-1

Ø 1,8 mm



curva
per retrograde
13 cm
1009-4

plastica autoclavabile

Ø 2 mm



retto
1021-1
punta + manico
1021-1P
punta di ricambio
(10 pz / confezione)

Ø 2 mm



45°
1021-2
punta + manico
1021-2P
punta di ricambio
(10 pz / confezione)

Ø 2 mm



90°
1021-3
punta + manico
1021-3P
punta di ricambio
(10 pz / confezione)

Spatole per cemento

set da 5



- 1 S0903-1
- 2 S0903-2
- 3 S0903-3

piastra in vetro per miscelazione

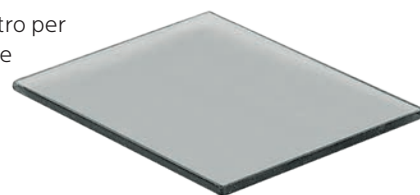

8x12x0,5 cm
0999-1



- 1 141 mm 0900-1
- 2 174 mm 0900-2
- 00 183 mm 0903-00
- 2 177 mm 0903-2
- 3 190 mm 0903-3
- 4 200 mm 0903-4

Spatole Heidemann



- 1 1100-1 Ottagonale
- 2 1100-2 Ottagonale
- 3 1100-3 Ottagonale
- 1 1101-1 Asa60
- 2 1101-2 Asa60
- 3 1101-3 Asa60

Spatole Heidemann

set da 5



- 1
S1102-1
Asa60
- 2
S1102-2
Asa60
- 3
S1102-3
Asa60

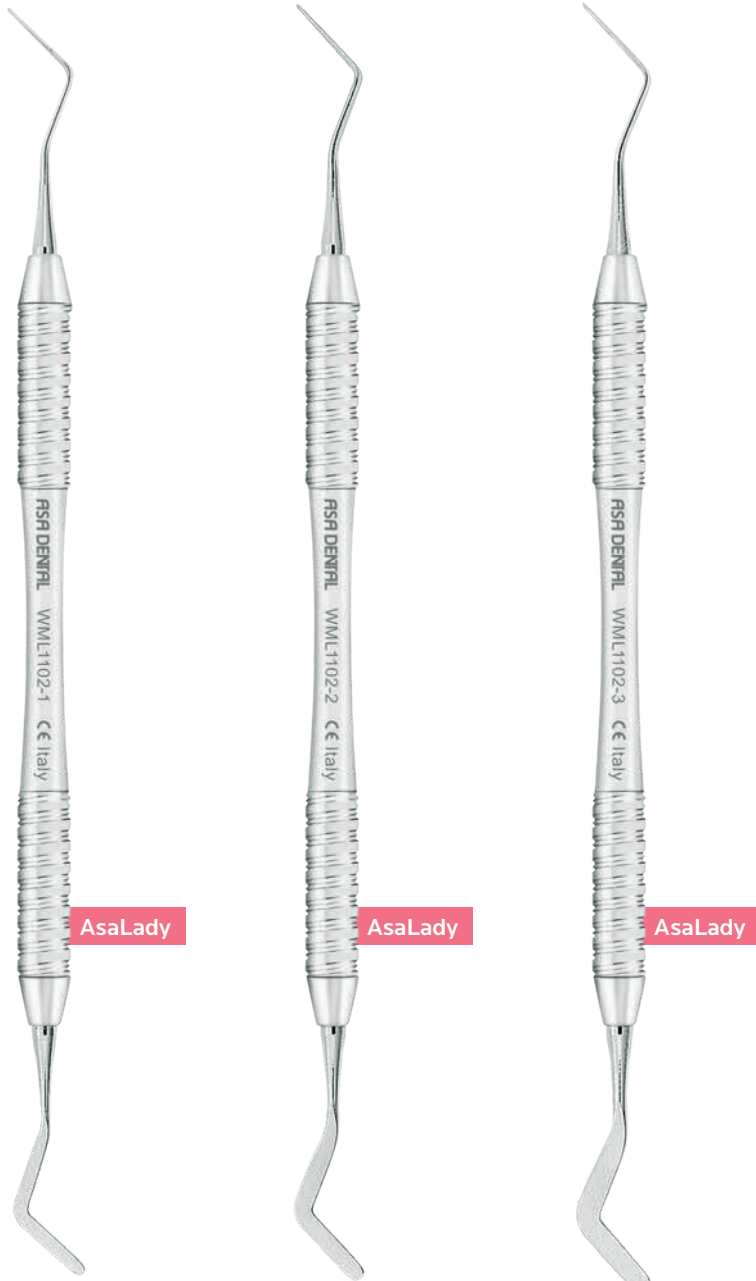

AsaLady

AsaLady

AsaLady

- 1
1102-1
Asa60
MV1102-1
Asa Light MV
WML1102-1
Leonardo ML
MC1102-1
● Magic Color MC
- 2
1102-2
Asa60
MV1102-2
Asa Light MV
WML1102-2
Leonardo ML
MC1102-2
● Magic Color MC
- 3
1102-3
Asa60
MV1102-3
Asa Light MV
WML1102-3
Leonardo ML

Spatole Heidemann

con punte rivestite al nitruro di titanio

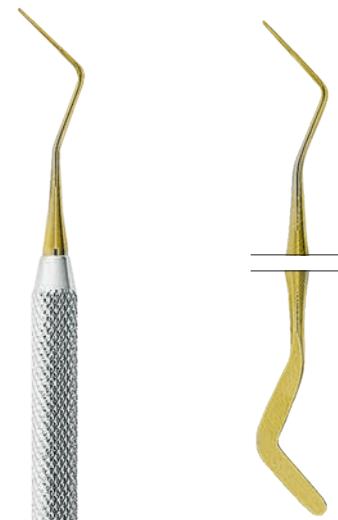

- 3
1102T-3
Asa60

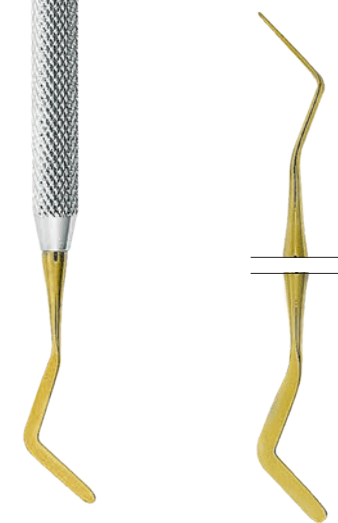

- 1
1102T-1
Asa60
- 2
1102T-2
Asa60

Otturatori per amalgama

con punte rivestite al nitruro di titanio

set da 5

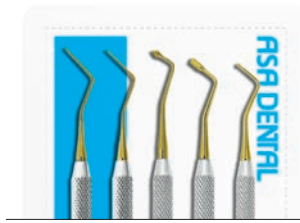

- 1200T-1 · 1202T-2 · 1204T-1
- 1102T-1 · 1102T-2
- S1200T
- Asa60

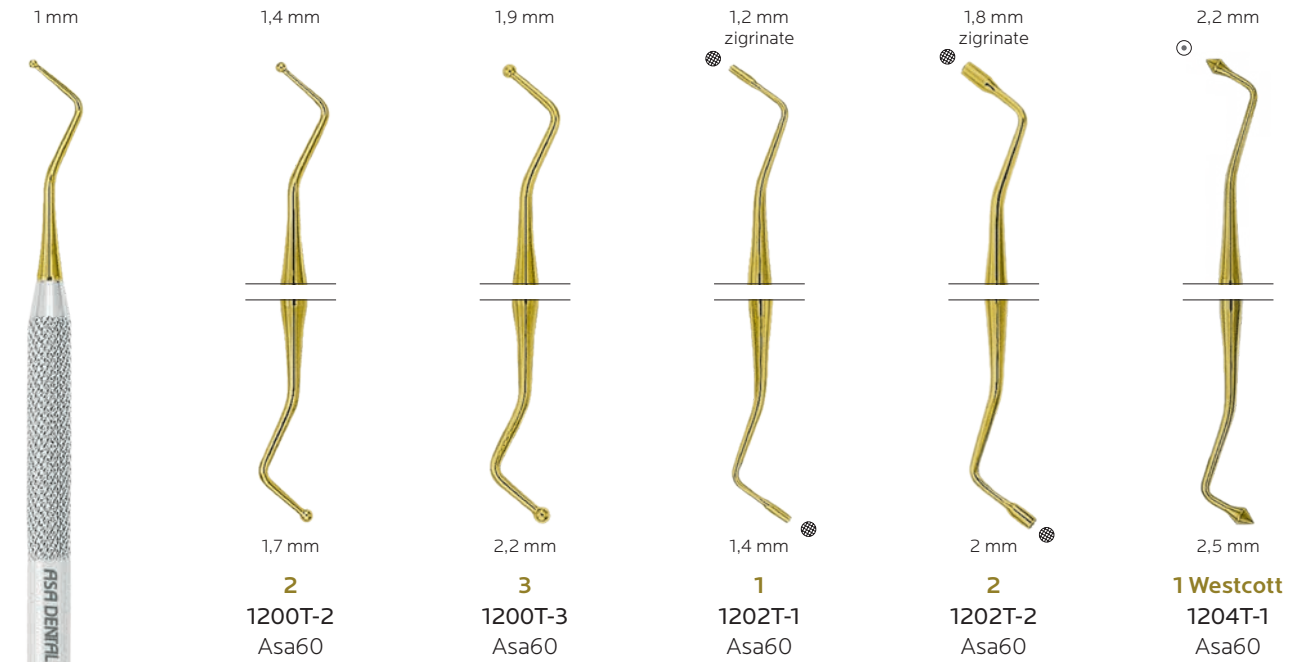

- 1 mm
- 1,4 mm
- 1,9 mm
- 1,2 mm zigrinate
- 1,8 mm zigrinate
- 2,2 mm
- 1,7 mm
- 2,2 mm
- 1,4 mm
- 2 mm
- 2,5 mm
- 2
1200T-2
Asa60
- 3
1200T-3
Asa60
- 1
1202T-1
Asa60
- 2
1202T-2
Asa60
- 1 Westcott
1204T-1
Asa60

1200T-2

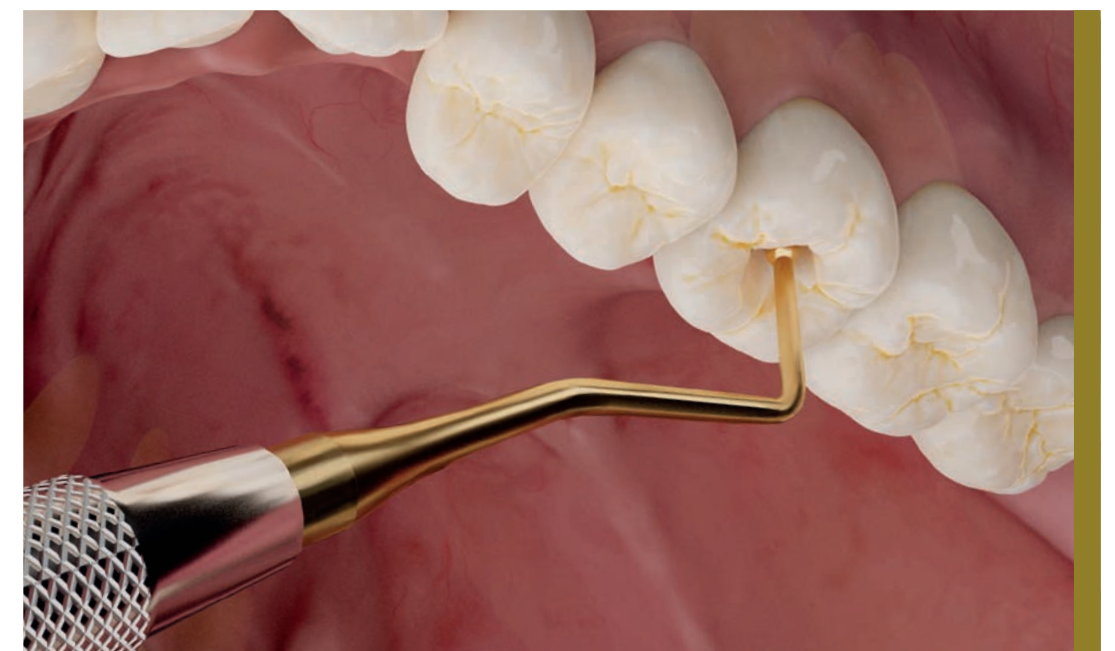

Otturatori per amalgama

set da 5



- | | |
|------------------------------|------------------------------|
| 1
S1200-1
Asa60 | 3
S1200-3
Asa60 |
| 2
S1200-2
Asa60 | 4
S1200-4
Asa60 |
| | 5
S1200-5
Asa60 |

Otturatori per amalgama

1 mm	1 mm	1,9 mm	1 mm zigrinate	1,6 mm zigrinate	2,1 mm zigrinate	1,2 mm zigrinate	1,8 mm zigrinate	2,3 mm zigrinate	3 mm zigrinate	1,2 mm lisce	1,8 mm lisce
1,8 mm	2,2 mm	1 mm	2 mm	2,3 mm	2 mm	2,6 mm	3,2 mm	1,4 mm	2 mm		
2 1200-2 Asa60 MV1200-2 Asa Light MV	3 1200-3 Asa60 MV1200-3 Asa Light MV	1 1201-1 Asa60 MV1201-1 Asa Light MV	2 1201-2 Asa60 MV1201-2 Asa Light MV	3 1201-3 Asa60 MV1201-3 Asa Light MV	2 1202-2 Asa60 MV1202-2 Asa Light MV MC1202-2	3 1202-3 Asa60 MV1202-3 Asa Light MV	4 1202-4 Asa60 MV1202-4 Asa Light MV	1L 1202-1L Asa60 MV1202-1L Asa Light MV	2L 1202-2L Asa60 MV1202-2L Asa Light MV		
	2,5 mm	1,7 mm	1 mm lisce	1,6 mm lisce	2,1 mm lisce	2,3 mm lisce	3 mm lisce	1 mm	1,4 mm	1,8 mm	
1,2 mm	2,9 mm	2,9 mm	1,2 mm	2 mm	2,3 mm	2,6 mm	3,2 mm	1,2 mm	1,6 mm	2 mm	
1 1200-1 Asa60 MV1200-1 Asa Light MV	4 1200-4 Asa60 MV1200-4 Asa Light MV	5 1200-5 Asa60 MV1200-5 Asa Light MV	1L 1201-1L Asa60 MV1201-1L Asa Light MV	2L 1201-2L Asa60 MV1201-2L Asa Light MV	3L 1201-3L Asa60 MV1201-3L Asa Light MV	1 1202-1 Asa60 MV1202-1 Asa Light MV	3L 1202-3L Asa60 MV1202-3L Asa Light MV	4L 1202-4L Asa60 MV1202-4L Asa Light MV	1 1203-1 Asa60 MV1203-1 Asa Light MV	2 1203-2 Asa60 MV1203-2 Asa Light MV	3 1203-3 Asa60 MV1203-3 Asa Light MV

● Magic Color MC









Otturatori per amalgama

Otturatori per amalgama Markley

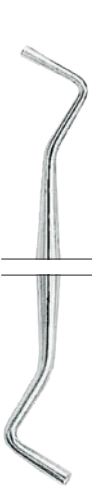
set da 6

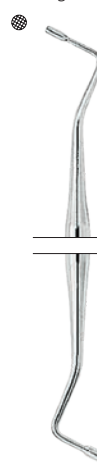
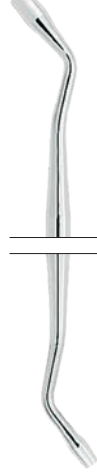
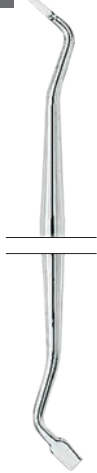

- 1 · 2 · 3 · 4 · 5 · 6
- S1400
- Asa60
- 1 · 2 · 3 · 4 · 5 · 6
- SMV1400
- Asa Light MV

<p>1,5 mm</p>  <p>2 mm</p> <p>1 Ward 1205-1 Asa60 MV1205-1 Asa Light MV</p>	<p>2,4 mm</p>  <p>2,8 mm</p> <p>2 Ward 1205-2 Asa60 MV1205-2 Asa Light MV</p>	<p>1,4 mm</p>  <p>0,8 mm</p> <p>OT Tanner 1211-OT Asa60 MV1211-OT Asa Light MV</p>	<p>2,4 mm</p>  <p>1,4 mm</p> <p>1T Tanner 1211-1T Asa60 MV1211-1T Asa Light MV</p>	<p>1,2 mm</p>  <p>0,8 mm</p> <p>2T Tanner 1211-2T Asa60 MV1211-2T Asa Light MV</p>	<p>1,8 mm</p>  <p>1,5 mm</p> <p>3T Tanner 1211-3T Asa60 MV1211-3T Asa Light MV</p>	<p>0,4 mm</p>  <p>0,6 mm</p> <p>1 Markley 1400-1 Asa60 MV1400-1 Asa Light MV</p>	<p>0,5 mm</p>  <p>1 mm</p> <p>2 Markley 1400-2 Asa60 MV1400-2 Asa Light MV MC1400-2</p> <p>● Magic Color MC</p>	<p>0,4 mm</p>  <p>1,2 mm</p> <p>3 Markley 1400-3 Asa60 MV1400-3 Asa Light MV</p>	<p>1 mm zigrinate</p>  <p>1,4 mm</p> <p>01 Marquette 1212-01 Asa60 MV1212-01 Asa Light MV</p>	<p>1,5 mm</p>  <p>1 mm</p> <p>H1 Hollenback 1213-H1 Asa60 MV1213-H1 Asa Light MV</p>	<p>3 mm</p>  <p>2 mm</p> <p>H2 Hollenback 1213-H2 Asa60 MV1213-H2 Asa Light MV</p>	<p>2,6 mm</p>  <p>1 mm</p> <p>H3 Hollenback 1213-H3 Asa60 MV1213-H3 Asa Light MV</p>	<p>1,8 mm</p>  <p>2,6 mm</p> <p>H4 Hollenback 1213-H4 Asa60 MV1213-H4 Asa Light MV</p>	<p>3 mm</p>  <p>1,6 mm</p> <p>4 Markley 1400-4 Asa60 MV1400-4 Asa Light MV</p>	<p>1,2 mm</p>  <p>0,5 mm</p> <p>5 Markley 1400-5 Asa60 MV1400-5 Asa Light MV</p>	<p>3 mm</p>  <p>1,6 mm</p> <p>6 Markley 1400-6 Asa60 MV1400-6 Asa Light MV</p>
--	---	--	--	--	--	---	---	--	---	--	--	--	--	--	--	---

Otturatori per amalgama Foc



0 Foc
1401-0
Asa60
ML1401-0
Leonardo ML

1S Foc
1401-1S
Asa60
ML1401-1S
Leonardo ML

2 Foc
1401-2
Asa60
ML1401-2
Leonardo ML

2S Foc
1401-2S
Asa60
ML1401-2S
Leonardo ML

0S Foc
1401-0S
Asa60
ML1401-0S
Leonardo ML

1 Foc
1401-1
Asa60
ML1401-1
Leonardo ML

Otturatori - Brunitori

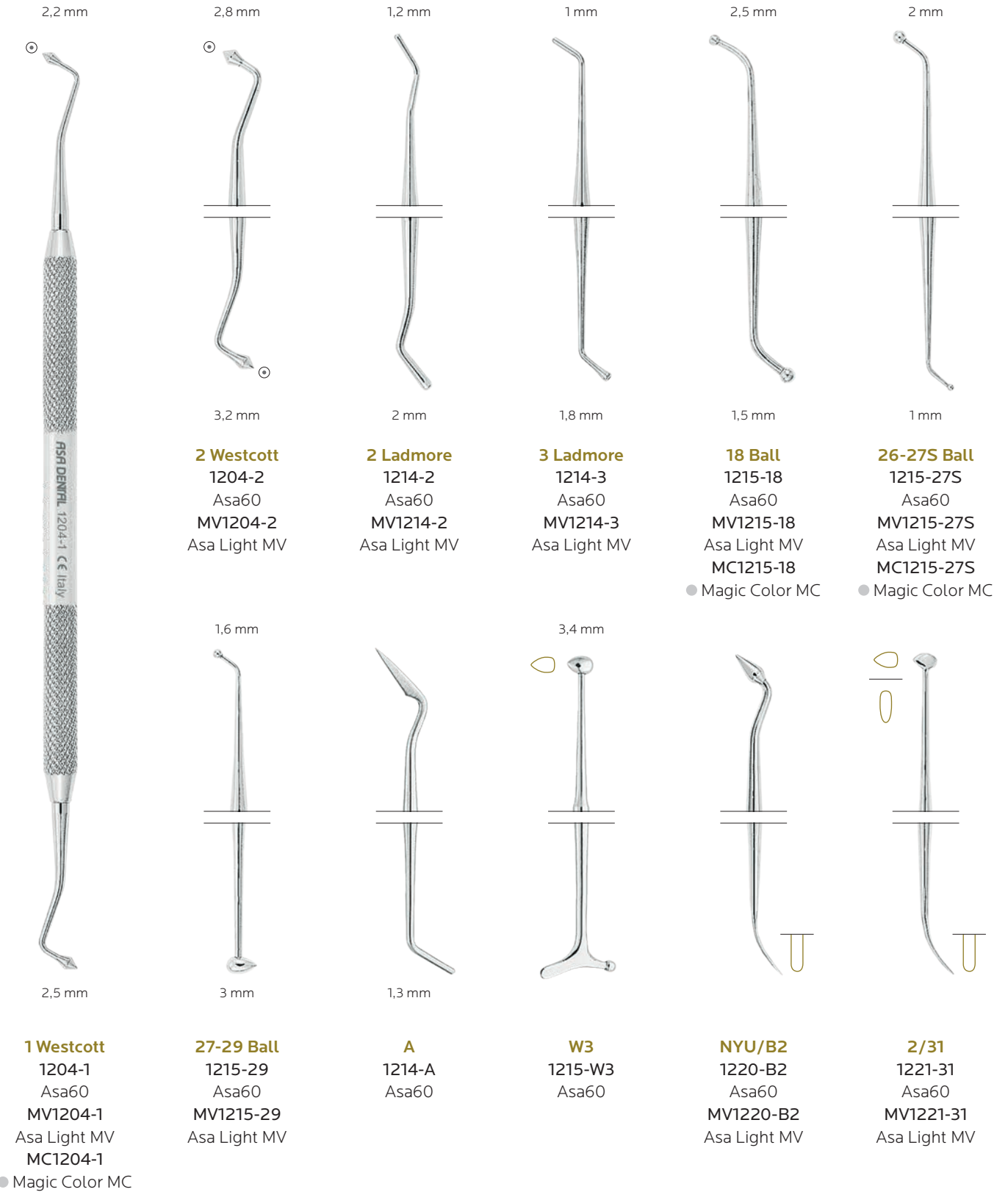

1 Westcott
1204-1
Asa60
MV1204-1
Asa Light MV
MC1204-1
● Magic Color MC

27-29 Ball
1215-29
Asa60
MV1215-29
Asa Light MV

A
1214-A
Asa60

W3
1215-W3
Asa60

NYU/B2
1220-B2
Asa60
MV1220-B2
Asa Light MV

2/31
1221-31
Asa60
MV1221-31
Asa Light MV

2 Westcott
1204-2
Asa60
MV1204-2
Asa Light MV

2 Ladmore
1214-2
Asa60
MV1214-2
Asa Light MV

3 Ladmore
1214-3
Asa60
MV1214-3
Asa Light MV

18 Ball
1215-18
Asa60
MV1215-18
Asa Light MV
MC1215-18
● Magic Color MC

26-27S Ball
1215-27S
Asa60
MV1215-27S
Asa Light MV
MC1215-27S
● Magic Color MC

2,2 mm

2,8 mm

1,2 mm

1 mm

2,5 mm

2 mm

3,2 mm

2 mm

1,8 mm

1,5 mm

1 mm

1,6 mm

3,4 mm

2,5 mm

3 mm

1,3 mm

Strumenti per composito Felt

set da 6



1 · 2 · 3 · 4 · 5 · 6
S1220
● Alu60



1 Felt
1220-1
● Alu60

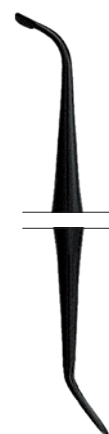

2 Felt
1220-2
● Alu60

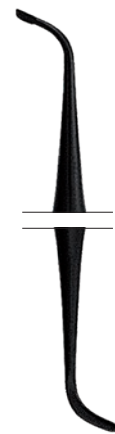

3 Felt
1220-3
● Alu60

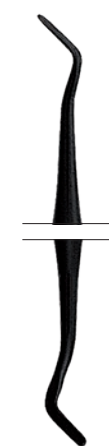

4 Felt
1220-4
● Alu60

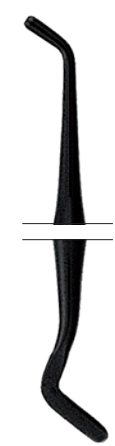

5 Felt
1220-5
● Alu60



6 Felt
1220-6
● Alu60

Strumenti per otturazioni plastiche

con punte rivestite al nitruro di titanio

1 mm



1
1208T-1
Asa60

1,6 mm



2
1208T-2
Asa60

2 mm



3
1208T-3
Asa60

2 mm



2
1209T-2
Asa60

2,9 mm



2
1210T-2
Asa60

Strumenti per otturazioni plastiche

Strumenti per otturazioni plastiche

1,2 mm	1,6 mm	1,2 mm	1,6 mm	1 mm	2,5 mm
0,1 mm	0,1 mm	2,2 mm	2,7 mm	2 mm	
1	2	1	2	1	
1206-1	1206-2	1207-1	1207-2	1208-1	
Asa60	Asa60	Asa60	Asa60	Asa60	
MV1206-1	MV1206-2	MV1207-1	MV1207-2	MV1208-1	
Asa Light MV	Asa Light MV	Asa Light MV	Asa Light MV	Asa Light MV	
0,7 mm	2,5 mm	1 mm	2 mm		
0,1 mm	2,5 mm	3 mm	0,1 mm	0,1 mm	
2	3	1	2	3	
1208-2	1208-3	1209-1	1209-2	1209-3	
Asa60	Asa60	Asa60	Asa60	Asa60	
MV1208-2	MV1208-3	MV1209-1	MV1209-2	MV1209-3	
Asa Light MV	Asa Light MV	Asa Light MV	Asa Light MV	Asa Light MV	

	2	3	1 Woodson	2 Woodson
	1210-2	1210-3	1216-1	1216-2
	Asa60	Asa60	Asa60	Asa60
	MV1210-2	MV1210-3	MV1216-1	MV1216-2
	Asa Light MV	Asa Light MV	Asa Light MV	Asa Light MV
	MC1210-2			
	● Magic Color MC			
	3 Woodson	11	6	179
	1216-3	1217-11	1218-6	1219-179
	Asa60	Asa60	Asa60	Asa60
	MV1216-3	MV1217-11	MV1218-6	MV1219-179
	Asa Light MV	Asa Light MV	Asa Light MV	Asa Light MV

Strumenti per modellare e rifinire otturazioni

Strumenti per modellare e rifinire otturazioni



1/2 Hollenback
1500-02
Asa60
MV1500-02
Asa Light MV
MC1500-02

● Magic Color MC

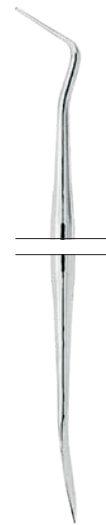

1 Ward
1501-1
Asa60
MV1501-1
Asa Light MV



2 Ward
1501-2
Asa60
MV1501-2
Asa Light MV

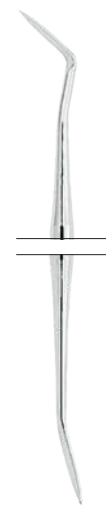

1S Ward
1501-1S
Asa60
MV1501-1S
Asa Light MV

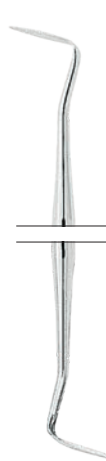

3 Hollenback
1500-3
Asa60
MV1500-3
Asa Light MV



3S Hollenback
1500-3S
Asa60
MV1500-3S
Asa Light MV



1 Frahm
1502-1
Asa60
MV1502-1
Asa Light MV

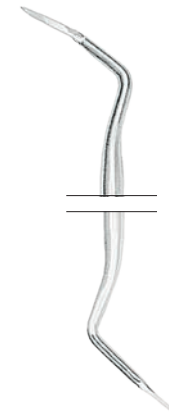

2 USC
1503-2
Asa60

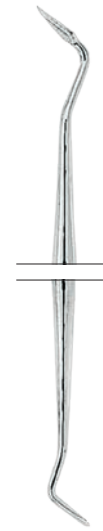

SHO-A
1505-A
Asa60

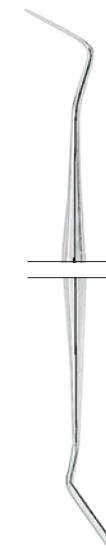

1 Interproximal
1504-1
Asa60



3-SHO
1505-3
Asa60

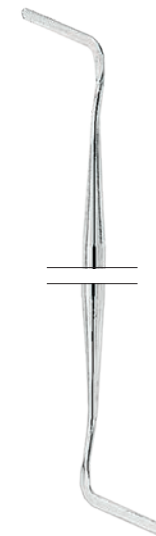

**2 Interproximal
off-angle**
1504-2
Asa60



104
1506-104
Asa60



8 Wiland
1507-8
Asa60
MV1507-8
Asa Light MV

Strumenti per modellare e rifinire otturazioni

strumenti per filo retrattore

Strumenti operativi

Strumento per l'applicazione di tinture e medicamenti

applicatori per sottofondo

porta tamponi



- 1**
cleoide-discoide
1600-1
Asa60
MV1600-1
Asa Light MV
MC1600-1
- 2**
cleoide-discoide
1600-2
Asa60
MV1600-2
Asa Light MV
- 3**
cleoide-discoide
1600-3
Asa60
MV1600-3
Asa Light MV
- 4**
cleoide-discoide
1600-4
Asa60
MV1600-4
Asa Light MV

● Magic Color MC

- 1**
1310-1
Asa60
- 2**
1310-2
Asa60

Orban Loop
1303
Ottagonale

1300
Asa35

1301
Asa60
MV1301
Asa Light MV

1302
Asa60
MV1302
Asa Light MV

1 Luniatschek
2 mm
1355-1
Ottagonale

2 Luniatschek
3 mm
1355-2
Ottagonale

Strumenti per corone

martelletti levacorone
completo di punte
doppia attacco

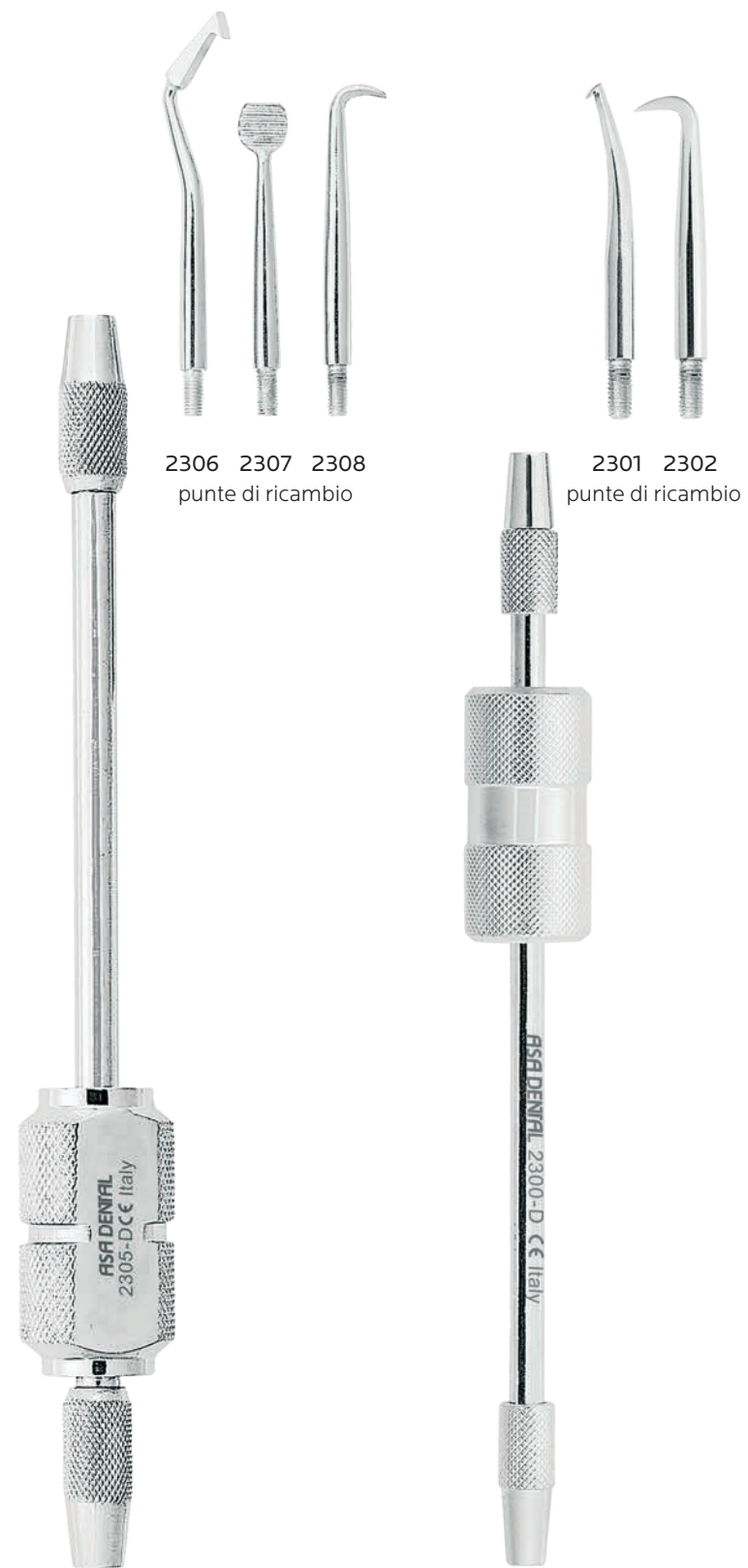

2306 2307 2308
punte di ricambio

2301 2302
punte di ricambio

2305-D
manico + 3 punte

2300-D
manico + 2 punte

martelletto levacorone
completo di punte
singola attacco



2301 2302
punte di ricambio

2300-S
manico + 2 punte

Strumenti per corone

strumenti levacorone e apricorone



2320

0
2340-0

1
2340-1

2
2340-2

3
2340-3

Strumenti per corone

calibri decimali

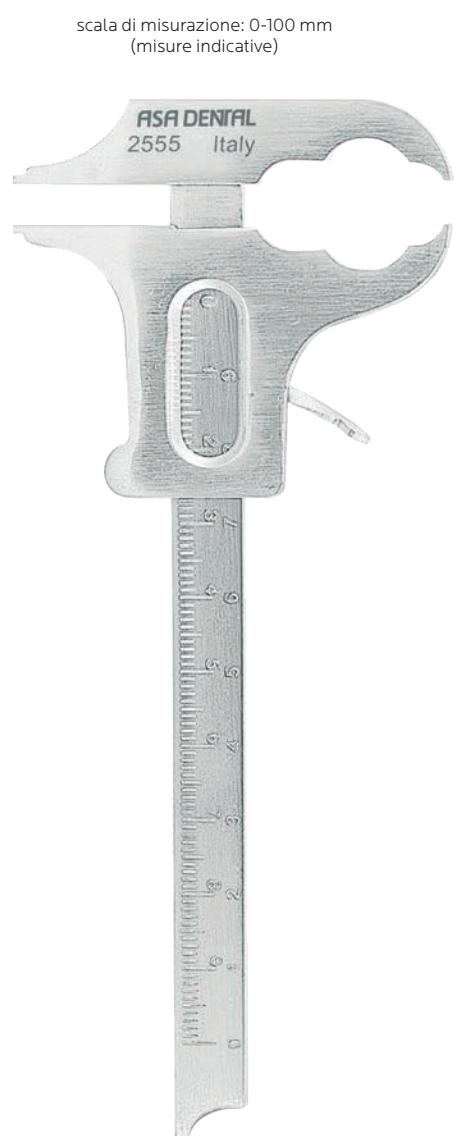

scala di misurazione: 0-100 mm
(misure indicative)

Boley
14 cm
2555



scala di misurazione: 0-10 mm
(misure indicative)

Iwanson
per cera
2550-1



scala di misurazione: 0-10 mm
(misure indicative)

Iwanson
per metallo
2550-2

pinzette per carta da articolazione



Miller
15 cm
0670

15 cm
0671

Strumenti per corone

pinze telescopiche per corone

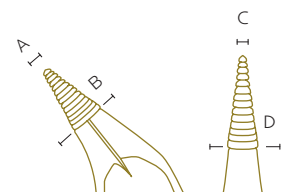

A	4,4 mm
B	5,0 mm
C	3,4 mm
D	3,8 mm



Böhm
14,5 cm
2500-2

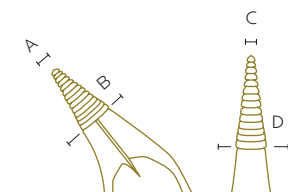

A	3,3 mm
B	4,0 mm
C	2,3 mm
D	3,0 mm



Böhm
11,5 cm
2500-1

pinze per togliere anelli di rame



Furrer
retta
16 cm
2331-1



Furrer
curva
16 cm
2331-2

Pinze emostatiche



1 Halstead-Mosquito
retta
12 cm
0500-1



1 Micro-Mosquito
retta
10 cm
0501-1



1 Kelly
retta
14 cm
0510-1

Forbicine

per fogli d'oro



1
retta
12 cm
0300-1

forbicine universali
lame rivestite al nitruro di titanio



TC Universale
12 cm
5700TC

forbicine universali
una lama dentellata



Universale
12 cm
5700

Forbicine per corone



1
retta
una lama dentellata
10,5 cm
5600-1



2
curva
una lama dentellata
10,5 cm
5600-2



1
retta
10,5 cm
5601-1



2
curva
10,5 cm
5601-2

Porta matrici



Matrici

a nastro

per porta matrici
3070-5
3071
3072
3073-1
3073-2
3073-3

per porta matrici
3070-6
3070-7
3071
3072
3073-1
3073-2
3073-3

per porta matrici
3070-7
3071
3072
3073-1
3073-2
3073-3



Tofflemire

12 pz / confezione

12 pz / confezione
assortiti:
3081-1
3081-2
3081-3

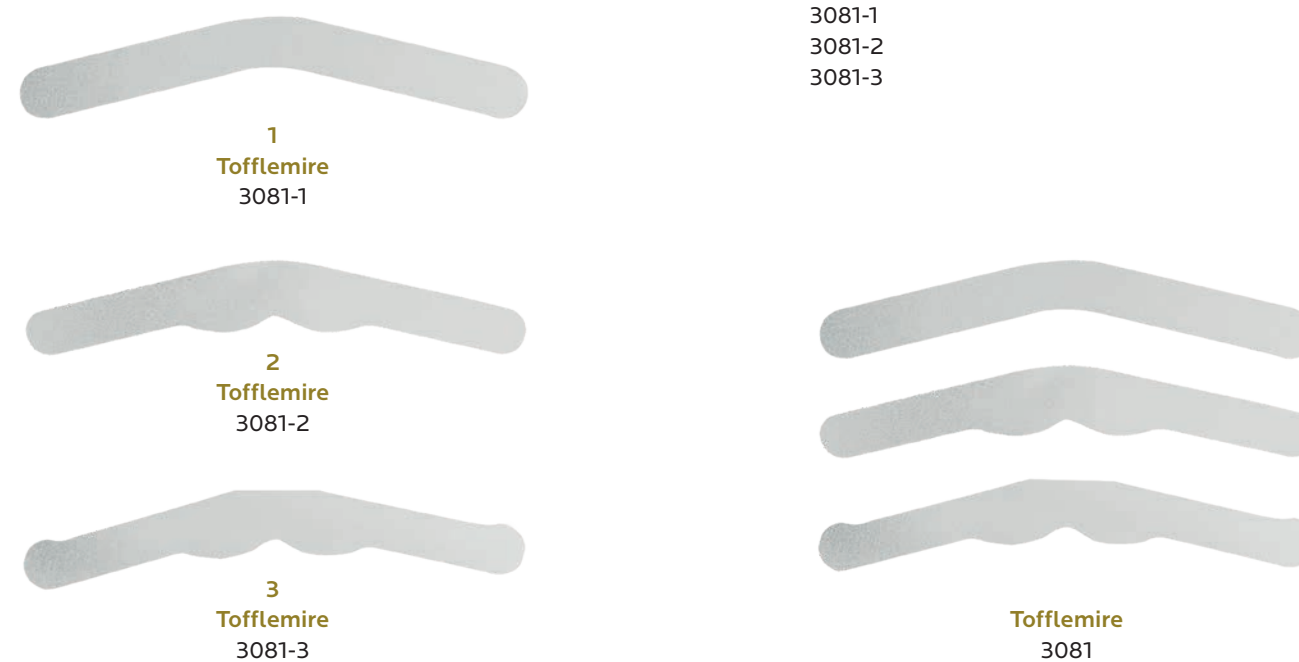

Strumenti per composito

Molari e Premolari

Molari, Premolari, Incisivi e Canini

Strumenti per composito

Molari, Premolari, Incisivi e Canini

Molari e Premolari



Asa Com 1/1B
5112-3
Asa60

Asa Com 2/2B
0704-16D2
Asa60

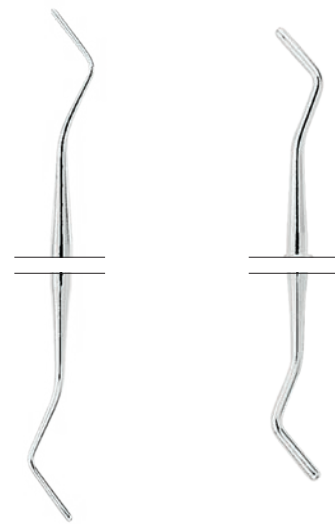

Asa Com 3/3B
1203-1
Asa60

Asa Com 4/4B
1203-3
Asa60

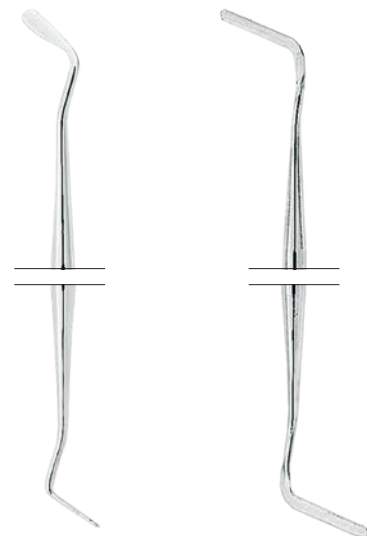

Asa Com 5/5B
1219-179
Asa60

Asa Com 6/6B
1504-2
Asa60

Asa Com 1/1B

due punte della stessa forma ma dimensioni diverse per il riempimento e la modellazione delle facce occlusali di premolari e molari Universale

Asa Com 2/2B

stessa punta ma due angoli diversi per la modellazione dei solchi occlusali di premolari e molari Universale

Asa Com 3/3B

otturatore versatile con punte semisferiche di due diverse dimensioni, ideale per posizionamento e definizione del composito valido per: classe 1, 2, 3, 4 e 5

Asa Com 4/4B

otturatore versatile con punte semisferiche di due diverse dimensioni, ideale per posizionamento e definizione del composito valido per: classe 1, 2, 3, 4 e 5

Asa Com 5/5B

strumento versatile per l'applicazione, la stratificazione e la modellazione del composito, dotato di punte opposte ad angolazione frontale e laterale valido per: classe 1, 2, 3, 4 e 5

Asa Com 6/6B

strumento ideale per il riempimento e la modellazione in aree mesiali e distali valido per: classe 2, 3 e 5



Asa Com 7/7B
5153-1
● Alu80

Asa Com 8/8B
1220-B2
Asa60

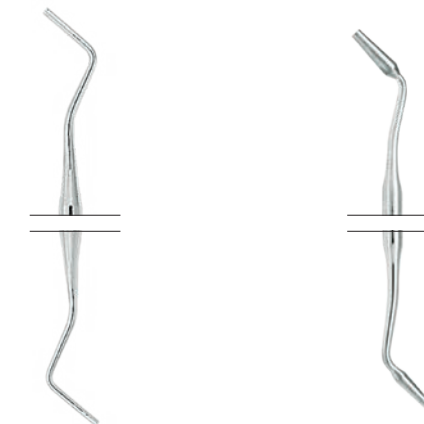

Asa Com 9/9B
1201-1L
Asa60

Asa Com 11/11B
1401-1
Asa60

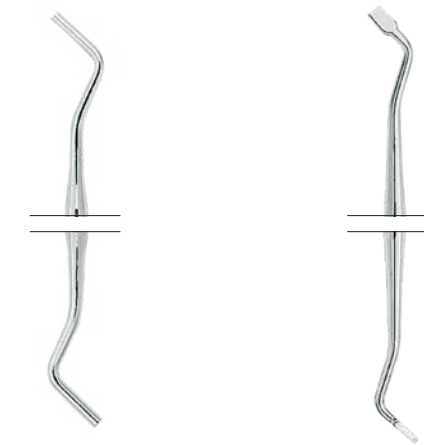

Asa Com 10/10B
1201-2L
Asa60

Asa Com 12/12B
1213-H3
Asa60

Asa Com 7/7B

strumento versatile per la definizione nelle zone gengivali ma utilizzabile anche nelle aree mesiali e distali valido per: classe 1, 2, 3, 4 e 5

Asa Com 8/8B

strumento che combina una punta per la modellazione delle aree occlusali e una paletta per le facce labiali. valido per: classe 1, 2, 3, 4 e 5

Asa Com 9/9B

otturatore munito di due punte piatte di dimensioni diverse valido per: classe 1, 2, 3, 4 e 5

Asa Com 10/10B

otturatore munito di due punte piatte di dimensioni diverse valido per: classe 1, 2, 3, 4 e 5

Asa Com 11/11B

otturatore a sezione conica, munito di due punte di dimensioni diverse Universale

Asa Com 12/12B

otturatore con punte opposte ad angolazione frontale e laterale Universale

Strumenti per composito

Molari, Premolari, Incisivi e Canini



Asa Com 13/13B 5112-4
Asa60

Asa Com 15/15B 1210-3
Asa60

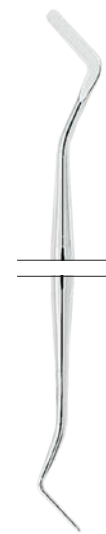

Asa Com 14/14B
1210-1
Asa60

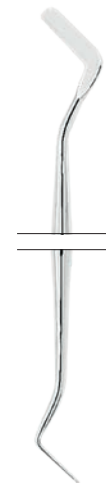

Asa Com 13/13B
strumento con lame opposte per il taglio, l'asportazione e la modellazione Universale

Asa Com 14/14B
strumento versatile per l'applicazione, la stratificazione e la modellazione del composito con punte opposte ad angolazione frontale e laterale Universale

Asa Com 15/15B
strumento versatile per l'applicazione, la stratificazione e la modellazione del composito con punte opposte ad angolazione frontale e laterale valido per: classe 2,3,4 e 5

Strumenti per composito Magic Color MC



MC1510-1D ● Magic Color MC

MC1510-2D ● Magic Color MC

MC1510-3D ● Magic Color MC

MC1510-4D ● Magic Color MC

MC1510-5D ○ Magic Color MC

Strumenti per composito



S1222-7

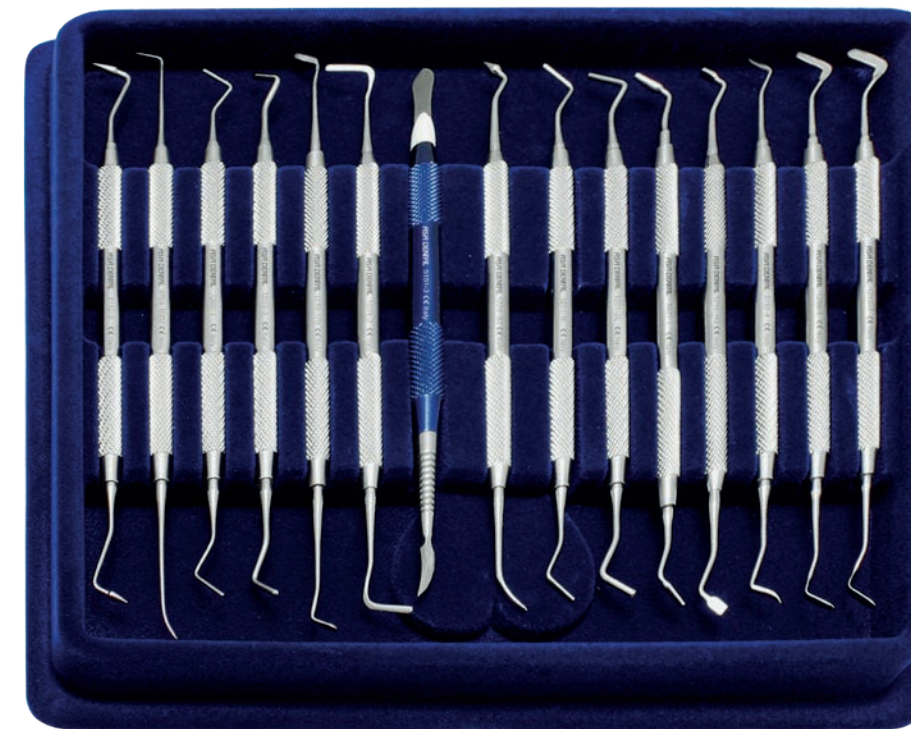

S1222-15

Asa Com 1/1B	5112-3
Asa Com 2/2B	0704-16D2
Asa Com 3/3B	1203-1
Asa Com 4/4B	1203-3
Asa Com 5/5B	1219-179
Asa Com 6/6B	1504-2
Asa Com 7/7B	5153-1

Asa Com 1/1B	5112-3
Asa Com 2/2B	0704-16D2
Asa Com 3/3B	1203-1
Asa Com 4/4B	1203-3
Asa Com 5/5B	1219-179
Asa Com 6/6B	1504-2
Asa Com 7/7B	5153-1
Asa Com 8/8B	1220-B2
Asa Com 9/9B	1201-1L
Asa Com 10/10B	1201-2L
Asa Com 11/11B	1401-1
Asa Com 12/12B	1213-H3
Asa Com 13/13B	5112-4
Asa Com 14/14B	1210-1
Asa Com 15/15B	1210-3

PARODONTOLOGIA

MADE IN ITALY

OTTIMIZZARE LE TEMPISTICHE, INCREMENTANDO LA SODDISFAZIONE DEL PAZIENTE

Noi di Asa Dental siamo consapevoli che ogni professionista si pone due obiettivi prioritari tra loro strettamente correlati: la soddisfazione dei propri pazienti e il buon uso del proprio tempo. Per questa ragione, il nostro target principale si è focalizzato sul garantire un'elevata qualità del prodotto nel minor lasso di tempo possibile. Lavoriamo marcando la nostra produzione di innovazione e progresso, vagliando con estrema cura ogni soluzione progettuale in modo da fornire agli specialisti strumenti esclusivi di nuovo ordine sia in termini di forma, che di impugnatura e dimensione.

- G3 Sonde millimetriche
- G4 Curette e Scaler
- G11 Curette Gracey
- G14 Scaler
- G16 Scollaperiostio ed Elevatori
- G20 Cucchiari alveolari
- G22 Lime
- G24 Bisturi per gengivectomia
- G26 Scalpelli e sgorbie
- G29 Martelli chirurgici
- G30 Accessori
- G31 Pinzette per marcare le tasche
- G32 Pietre per affilare
- G34 Kit

Manici

PUNTA SINGOLA

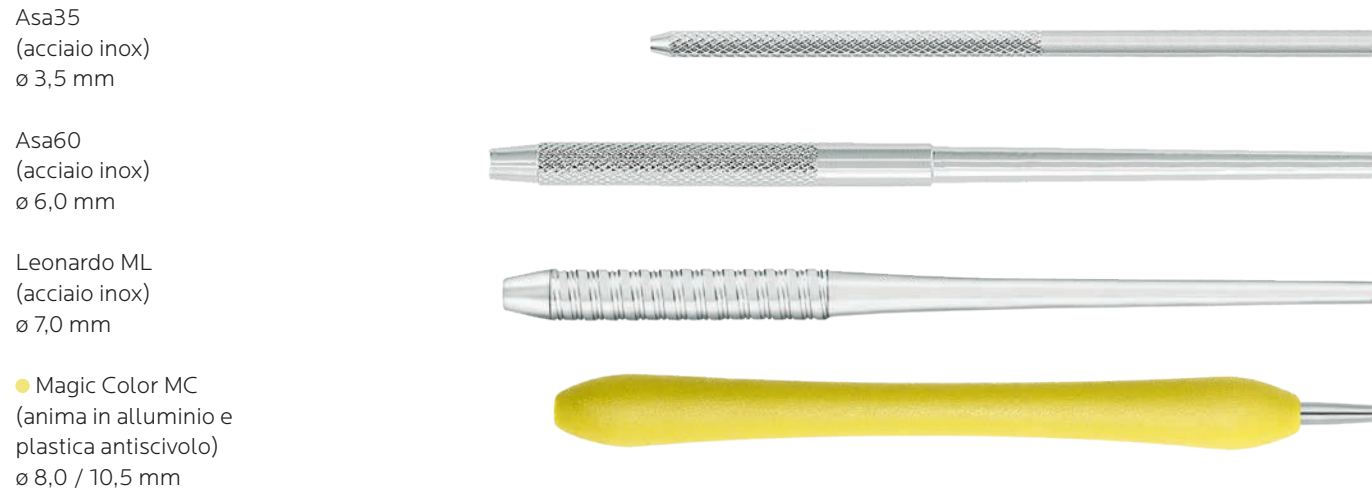

PUNTA DOPPIA



Come usare le informazioni

- CP-12 → modello + nome scientifico
- MC0702-12 → codice Asa Dental
- Magic Color MC → manico

Sonde millimetriche parodontali



Facili e veloci da pulire, queste sonde parodontali garantiscono tutta la necessaria precisione. Le incisioni per la misurazione della profondità resistono alle condizioni d'uso più estreme assicurandone l'affidabilità e l'efficacia nel tempo. Il design ergonomico dell'impugnatura trasforma le sonde nella naturale estensione della tua mano.

- Nuovo processo produttivo
- Sistema di incisione al laser
- Evita pericolose perdite di vernice
- Garantisce una marcatura indelebile
- Le incisioni sono a basso spessore e prive di riflessi
- Il processo mantiene intatta la robustezza delle punte

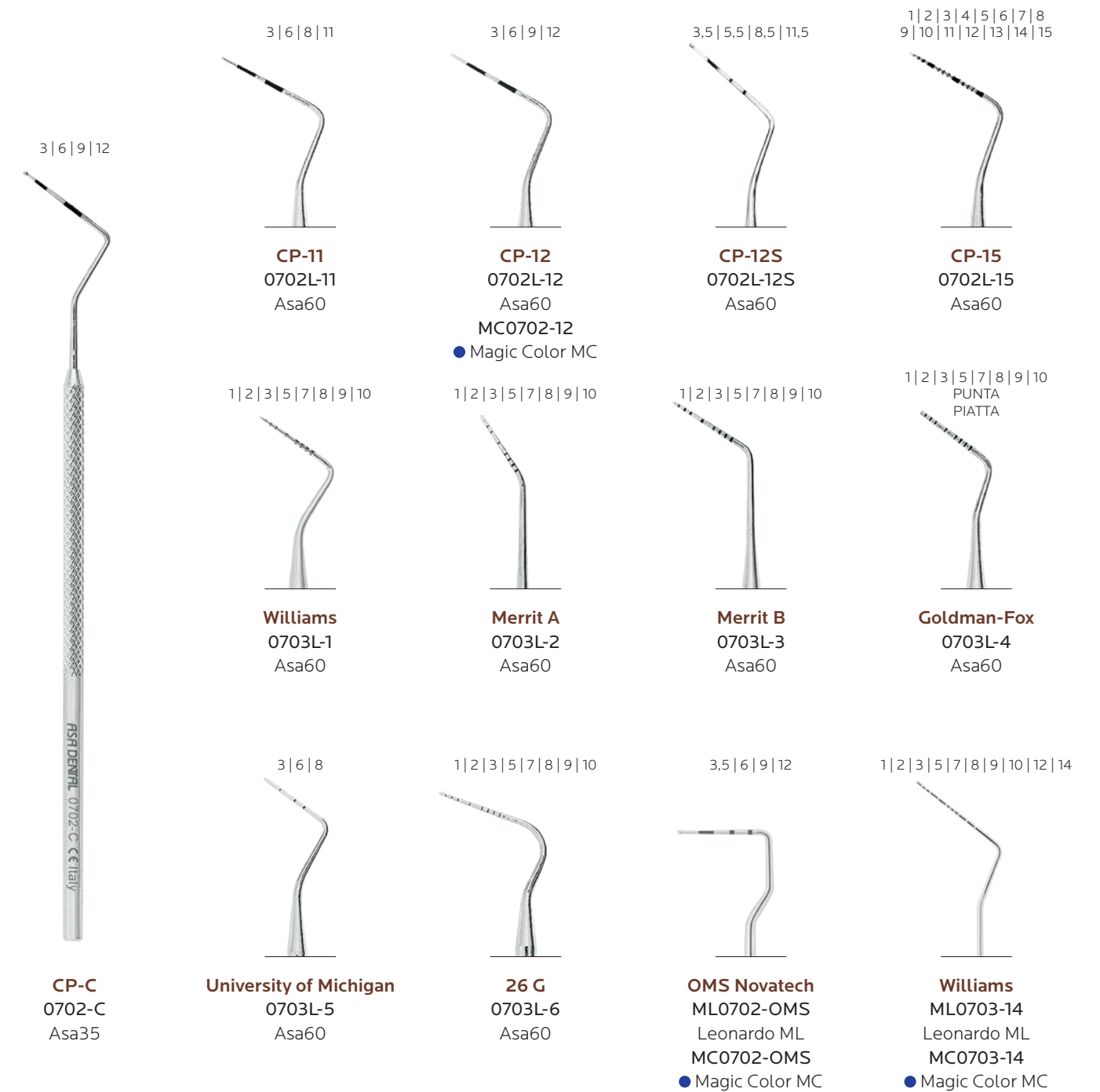

Curette e Scaler

set da 7



02 · 2RL · 4RL · 14 · 412 · 414 · Z
S1806
Asa60
02 · 2RL · 4RL · 14 · 412 · 414 · Z
SMV1806
Asa Light MV



HU 1/2
1806-02
Asa60
MV1806-02
Asa Light MV

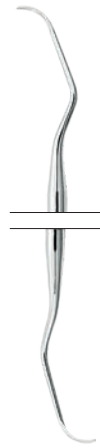

2R/2L Columbia
1806-2RL
Asa60
MV1806-2RL
Asa Light MV
ML1806-2RL
Leonardo ML
MC1806-2RL
● Magic Color MC



411/412 Columbia
1806-412
Asa60
MV1806-412
Asa Light MV

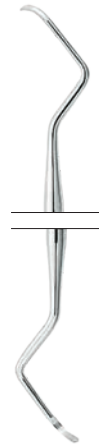

4R/4L Columbia
1806-4RL
Asa60
MV1806-4RL
Asa Light MV
ML1806-4RL
Leonardo ML
MC1806-4RL
● Magic Color MC



413/414 Columbia
1806-414
Asa60
MV1806-414
Asa Light MV

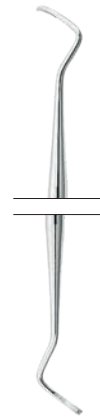

13/14 Columbia
1806-14
Asa60
MV1806-14
Asa Light MV
ML1806-14
Leonardo ML
MC1806-14
● Magic Color MC



Zerfing-Chisel
1820-Z
Asa60



HU 1/2 Langer
1805-02
Asa60
MV1805-02
Asa Light MV

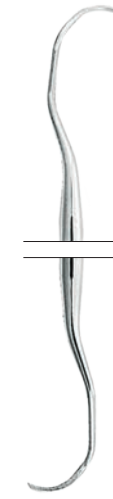

3/4 Langer
1805-04
Asa60
MV1805-04
Asa Light MV

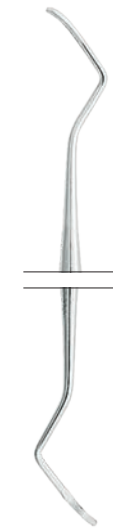

5/6 Barnhart
1821-06
Asa60

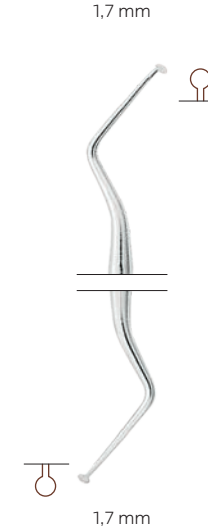

1 De Marco
1808-1
Asa60

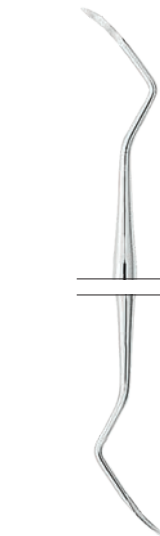

13/14 Indiana University anterior
1824-14
Asa60
MV1824-14
Asa Light MV

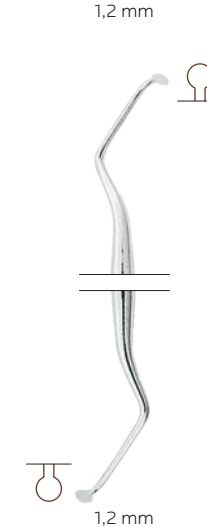

2 De Marco
1808-2
Asa60

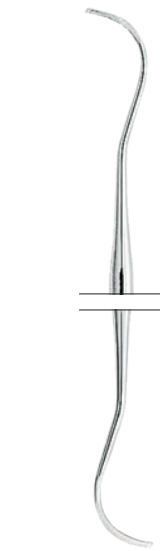

17/18 Indiana University posterior
1824-18
Asa60
MV1824-18
Asa Light MV

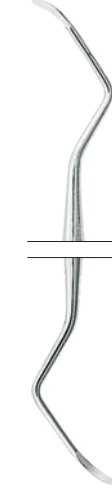

1/2 Barnhart
1821-02
Asa60

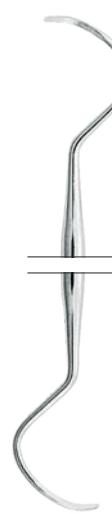

ME-1 (10/11)
1822-ME1
Asa60



3/4 Rule (23/24)
1823-R04
Asa60

Curette e Scaler

set da 7



1 · 2 · 3 · 4 · 5 · 6 · 21

S1809

Asa60

1 · 2 · 3 · 4 · 5 · 6 · 21

SMV1809

Asa Light MV



1 Goldman-Fox
1809-1
Asa60
MV1809-1
Asa Light MV
ML1809-1
Leonardo ML

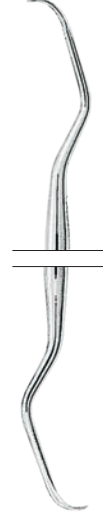

2 Goldman-Fox
1809-2
Asa60
MV1809-2
Asa Light MV
ML1809-2
Leonardo ML

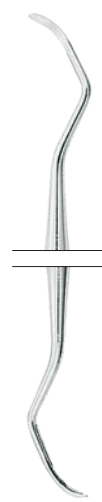

3 Goldman-Fox
1809-3
Asa60
MV1809-3
Asa Light MV
ML1809-3
Leonardo ML

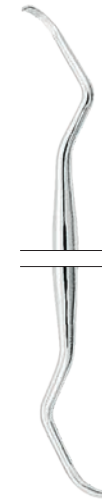

4 Goldman-Fox
1809-4
Asa60
MV1809-4
Asa Light MV
ML1809-4
Leonardo ML

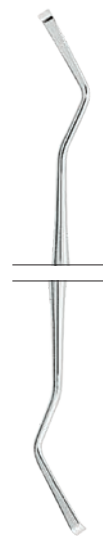

5 Goldman-Fox
1809-5
Asa60
MV1809-5
Asa Light MV
ML1809-5
Leonardo ML

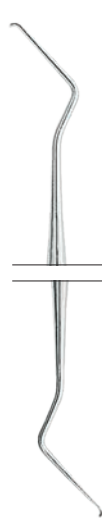

6 Goldman-Fox
1809-6
Asa60
MV1809-6
Asa Light MV

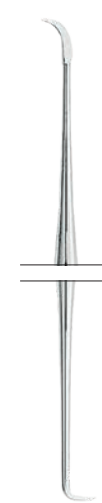

21 Goldman-Fox
1809-21
Asa60
MV1809-21
Asa Light MV
ML1809-21
Leonardo ML

Curette e Scaler



11/12 Mc Call
1825-12
Asa60
MV1825-12
Asa Light MV

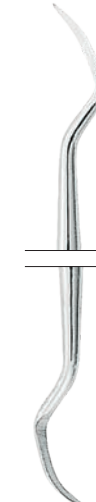

11A/12A Mc Call
1825-12A
Asa60



13S/14S Mc Call
1825-14S
Asa60
MV1825-14S
Asa Light MV
ML1825-14S
Leonardo ML



13/14 Mc Call
1825-14
Asa60
MV1825-14
Asa Light MV

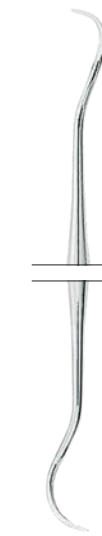

17S/18S Mc Call
1825-18S
Asa60
MV1825-18S
Asa Light MV



19/20 Mc Call
1825-20
Asa60
MV1825-20
Asa Light MV

Curette e Scaler



2/3 Taylor
1826-T03
Asa60
MV1826-T03
Asa Light MV
ML1826-T03
Leonardo ML
LV1826-T03
Leonardo Light LV

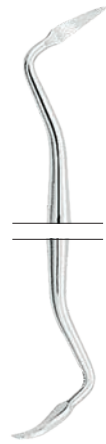

204
1827-204
Asa60

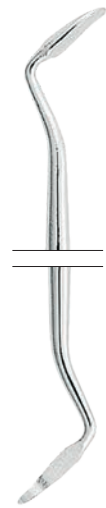

6 Crane-Kaplan
1829-CK6
Asa60
MV1829-CK6
Asa Light MV
ML1829-CK6
Leonardo ML
LV1829-CK6
Leonardo Light LV

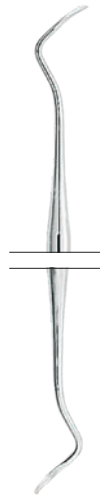

204S
1827-204S
Asa60
MV1827-204S
Asa Light MV
ML1827-204S
Leonardo ML
LV1827-204S
Leonardo Light LV
MC1827-204S
● Magic Color MC

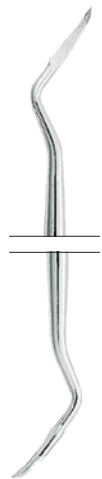

6S Mini Crane-Kaplan
1829-CK6S
Asa60
MV1829-CK6S
Asa Light MV
ML1829-CK6S
Leonardo ML
LV1829-CK6S
● Magic Color MC



7/8 Younger-Good
1830-YG08
Asa60
MV1830-YG08
Asa Light MV
ML1830-YG08
Leonardo ML



31/32 Jacquette
1831-32
Asa60
MV1831-32
Asa Light MV

Curette e Scaler

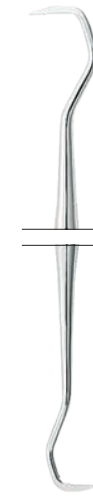

30/33 Jacquette
1831-33
Asa60
MV1831-33
Asa Light MV

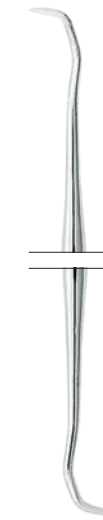

34/35 Jacquette
1831-35
Asa60
MV1831-35
Asa Light MV

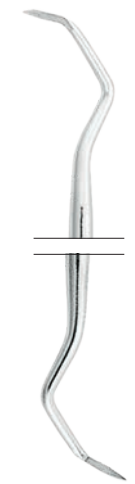

37/38 Jacquette
1831-38
Asa60
MV1831-38
Asa Light MV

1831-32



Tabella di applicazione Gracey

○	Arcate dei denti anteriori
GRA 1/2	Incisivi e Canini
GRA 3/4	Incisivi e Canini
GRA 5/6	Anteriori e Premolari
●	Superfici linguali e labiali dei denti posteriori
GRA 7/8	Premolari e Molari
GRA 9/10	Premolari e Molari
●	Superfici mesiali dei denti posteriori
GRA 11/12	Premolari e Molari
GRA 15/16	Premolari e Molari
●	Superfici distali dei denti posteriori
GRA 13/14	Molari
GRA 17/18	Molari

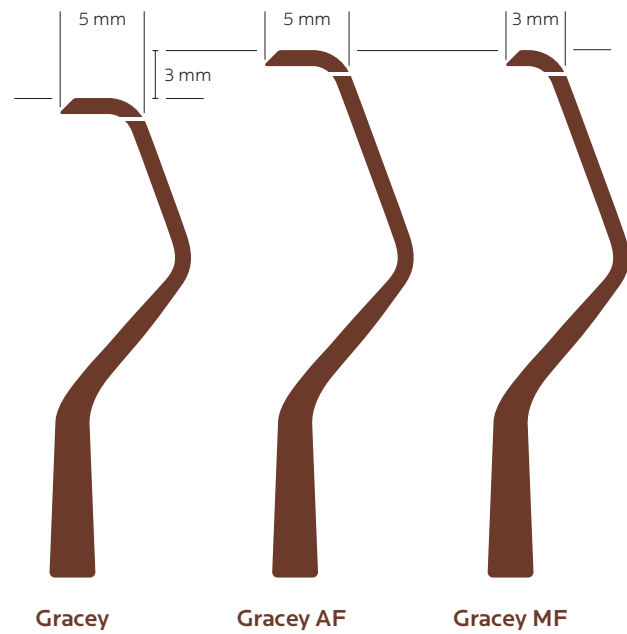
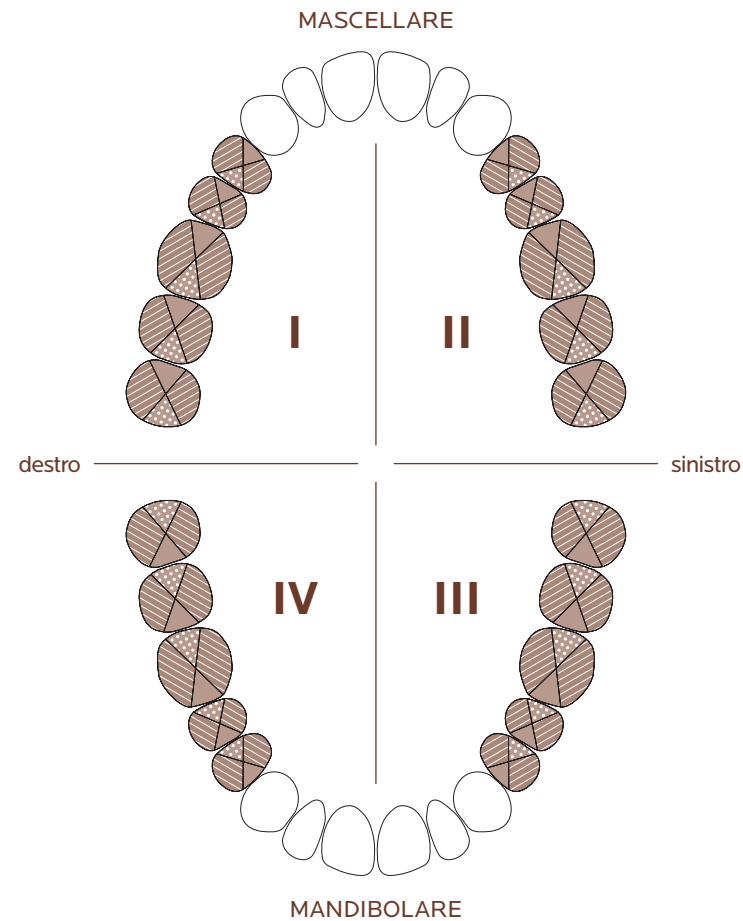

manici Magic Color

● GRA 1/2	● GRA 11/12
● GRA 3/4	● GRA 13/14
● GRA 5/6	● GRA 15/16
● GRA 7/8	● GRA 17/18
● GRA 9/10	

Curette Gracey

	3/4 Gracey 1807-04 Asa60 MV1807-04 Asa Light MV ML1807-04 Leonardo ML LV1807-04 Leonardo Light LV MC1807-04 ● Magic Color MC	5/6 Gracey 1807-06 Asa60 MV1807-06 Asa Light MV ML1807-06 Leonardo ML LV1807-06 Leonardo Light LV MC1807-06 ● Magic Color MC	7/8 Gracey 1807-08 Asa60 MV1807-08 Asa Light MV ML1807-08 Leonardo ML LV1807-08 Leonardo Light LV MC1807-08 ● Magic Color MC	9/10 Gracey 1807-10 Asa60 MV1807-10 Asa Light MV ML1807-10 Leonardo ML LV1807-10 Leonardo Light LV MC1807-10 ● Magic Color MC	11/12 Gracey 1807-12 Asa60 MV1807-12 Asa Light MV ML1807-12 Leonardo ML LV1807-12 Leonardo Light LV MC1807-12 ● Magic Color MC
	1/2 Gracey 1807-02 Asa60 MV1807-02 Asa Light MV ML1807-02 Leonardo ML LV1807-02 Leonardo Light LV MC1807-02 ● Magic Color MC	13/14 Gracey 1807-14 Asa60 MV1807-14 Asa Light MV ML1807-14 Leonardo ML LV1807-14 Leonardo Light LV MC1807-14 ● Magic Color MC	15/16 Gracey 1807-16 Asa60 ML1807-16 Leonardo ML LV1807-16 Leonardo Light LV MC1807-16 ● Magic Color MC	17/18 Gracey 1807-18 Asa60 ML1807-18 Leonardo ML LV1807-18 Leonardo Light LV MC1807-18 ● Magic Color MC	11/14 Gracey Mesial-Distal 1807-11MD Asa60 MV1807-11MD Asa Light MV ML1807-11MD Leonardo ML LV1807-11MD Leonardo Light LV
					12/13 Gracey Mesial-Distal 1807-13MD Asa60 MV1807-13MD Asa Light MV ML1807-13MD Leonardo ML LV1807-13MD Leonardo Light LV

Curette Gracey - AF



1/2 Gracey
1807-02AF
Asa60
ML1807-02AF
Leonardo ML
LV1807-02AF
Leonardo Light LV

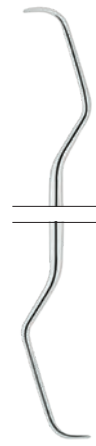

3/4 Gracey
1807-04AF
Asa60
ML1807-04AF
Leonardo ML
LV1807-04AF
Leonardo Light LV

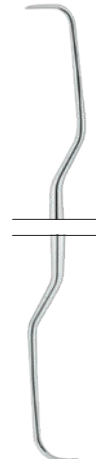

5/6 Gracey
1807-06AF
Asa60
ML1807-06AF
Leonardo ML
LV1807-06AF
Leonardo Light LV

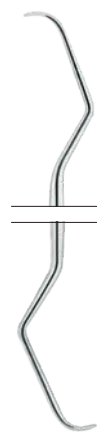

7/8 Gracey
1807-08AF
Asa60
ML1807-08AF
Leonardo ML
LV1807-08AF
Leonardo Light LV



11/12 Gracey
1807-12AF
Asa60
ML1807-12AF
Leonardo ML
LV1807-12AF
Leonardo Light LV



13/14 Gracey
1807-14AF
Asa60
ML1807-14AF
Leonardo ML
LV1807-14AF
Leonardo Light LV



15/16 Gracey
1807-16AF
Asa60
ML1807-16AF
Leonardo ML
LV1807-16AF
Leonardo Light LV

Curette Gracey - MF



1/2 Gracey
1807-02MF
Asa60
ML1807-02MF
Leonardo ML
LV1807-02MF
Leonardo Light LV
MC1807-02MF
● Magic Color MC

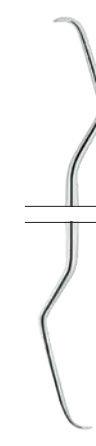

3/4 Gracey
1807-04MF
Asa60
ML1807-04MF
Leonardo ML
LV1807-04MF
Leonardo Light LV
MC1807-04MF
● Magic Color MC

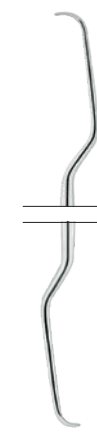

5/6 Gracey
1807-06MF
Asa60
ML1807-06MF
Leonardo ML
LV1807-06MF
Leonardo Light LV
MC1807-06MF
● Magic Color MC



7/8 Gracey
1807-08MF
Asa60
ML1807-08MF
Leonardo ML
LV1807-08MF
Leonardo Light LV
MC1807-08MF
● Magic Color MC



11/12 Gracey
1807-12MF
Asa60
ML1807-12MF
Leonardo ML
LV1807-12MF
Leonardo Light LV
MC1807-12MF
● Magic Color MC

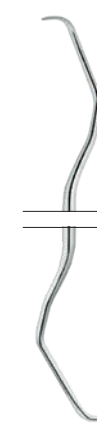

13/14 Gracey
1807-14MF
Asa60
ML1807-14MF
Leonardo ML
LV1807-14MF
Leonardo Light LV
MC1807-14MF
● Magic Color MC



15/16 Gracey
1807-16MF
Asa60
ML1807-16MF
Leonardo ML
LV1807-16MF
Leonardo Light LV
MC1807-16MF
● Magic Color MC

Scaler

Scaler



U15 Towner
1903
Asa60
ML1903
Leonardo ML

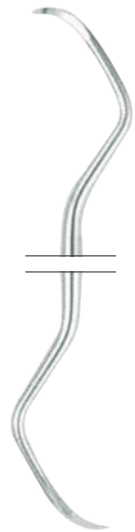

M23
Universal Scaler
1900-M23
Asa60
ML1900-M23
Leonardo ML



H5/33
1904-H5
Asa60
MV1904-H5
Asa Light MV

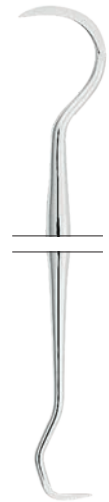

U15/33
Towner Jacquette
1902-1
Asa60
MV1902-1
Asa Light MV
ML1902-1
Leonardo ML
MC1902-1
● Magic Color MC

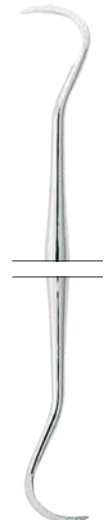

H6/H7
1904-H6
Asa60
MV1904-H6
Asa Light MV

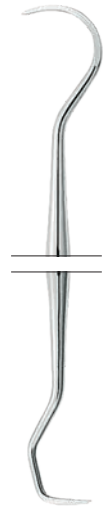

U15/30
Towner Jacquette
1902-2
Asa60
MV1902-2
Asa Light MV

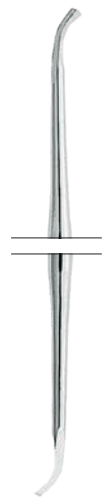

1/2
1905-02
Asa60
MV1905-02
Asa Light MV



1
1901-1
Asa60



1L
left
1900-1L
Asa60



H5 Hygienist
1909-H5
Asa60



1 Jacquette
ML1906-1
Leonardo ML



1R
right
1900-1R
Asa60



H6 Hygienist
1909-H6
Asa60



2 Jacquette
ML1906-2
Leonardo ML



2L
left
1900-2L
Asa60



H7 Hygienist
1909-H7
Asa60



3 Jacquette
ML1906-3
Leonardo ML



2R
right
1900-2R
Asa60



33
1906-33
Asa60

Scollaperiostio ed Elevatori

Scollaperiostio ed Elevatori

3 mm
PUNTA LANCEOLATA



3 mm
PUNTA ARROTONDATA

Buser
PR1850-M
Perfection

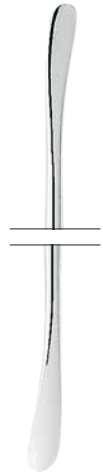

GF Goldman-Fox
MV1850-GF
Asa Light MV

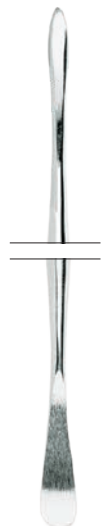

Beale
5114-1
Ottagonale

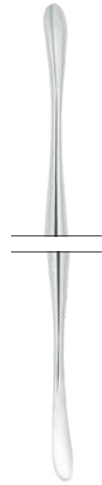

M7 Molt
MV1850-M7
Asa Light MV



9A Allen
MV1850-9A
Asa Light MV

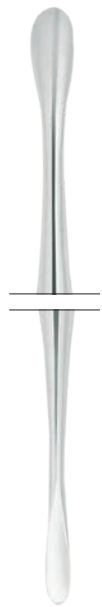

M8 Molt
MV1850-M8
Asa Light MV

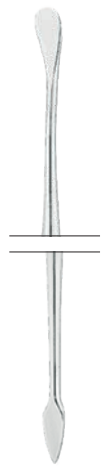

2 Hourigan
MV1851-2
Asa Light MV

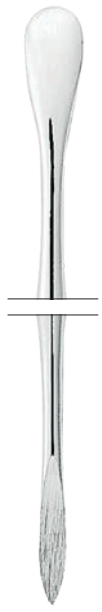

M9 Molt
MV1850-M9
Asa Light MV



PR3 Prichard
MV1851-PR3
Asa Light MV



Partsch
14,5 cm
1849-1
Asa60



1 Hopkins
MV1852-1
Asa Light MV

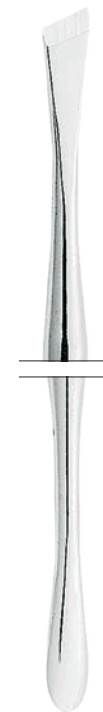

3 Mead
MV1854-3
Asa Light MV

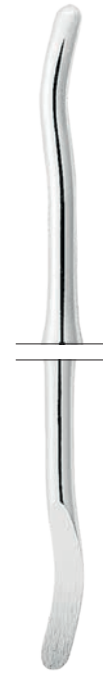

2 Hopkins
MV1852-2
Asa Light MV



15 Freer
MV1853-15
Asa Light MV



16 Freer
MV1853-16
Asa Light MV

Scollaperiostio ed Elevatori

Scollaperiostio ed Elevatori

2 mm



2,5 mm

17 cm
PR1850-1
Perfection



22 Seldin
retractor
1855-22



23 Seldin
retractor
1855-23



König
15,5 cm
1858-1



Williger
17 cm
1856-1



Williger
16 cm
1856-2



Williger
16 cm
1857-1



Williger
13 cm
1857-2

Cucchiai alveolari



1 Hemingway
2000-1
Asa60
MV2000-1
Asa Light MV
ML2000-1
Leonardo ML
MC2000-1
● Magic Color MC

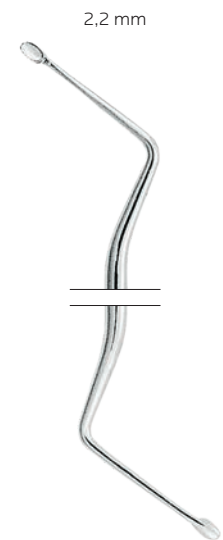

2 Hemingway
2000-2
Asa60
MV 2000-2
Asa Light MV
ML2000-2
Leonardo ML
MC2000-2
● Magic Color MC



3 Hemingway
2000-3
Asa60
MV 2000-3
Asa Light MV
ML2000-3
Leonardo ML
MC2000-3
● Magic Color MC

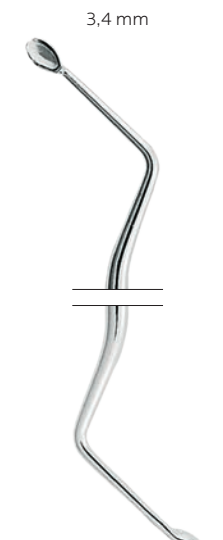

4 Hemingway
2000-4
Asa60
MV2000-4
Asa Light MV
ML2000-4
Leonardo ML

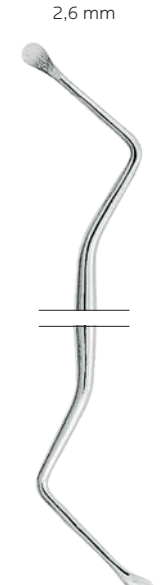

85 Lucas
2001-85
Asa60
MV2001-85
Asa Light MV
ML2001-85
Leonardo ML

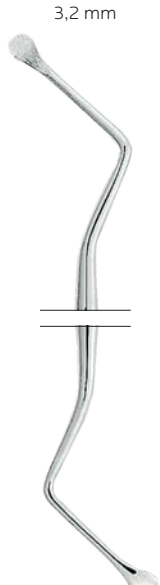

86 Lucas
2001-86
Asa60
MV2001-86
Asa Light MV
ML2001-86
Leonardo ML



87 Lucas
2001-87
Asa60
MV2001-87
Asa Light MV
ML2001-87
Leonardo ML



88 Lucas
2001-88
Asa60
MV2001-88
Asa Light MV
ML2001-88
Leonardo ML

Cucchiai alveolari



00/0 Williger
14 cm
2015-00



1/2 Williger
14 cm
2015-1



00/0
14 cm
2016-00



1/2
14 cm
2016-1



2
U.S.A. model
16 cm
2013-2



2R
U.S.A. model
16 cm
2013-2R

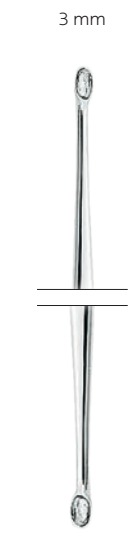

O/1 Williger
14 cm
2015-0

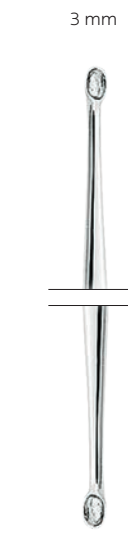

O/1
14 cm
2016-0



2L
U.S.A. model
16 cm
2013-2L

Lime

Lime per alveolotomia



3/7 Hirschfeld
1810-07
Asa60
MV1810-07
Asa Light MV

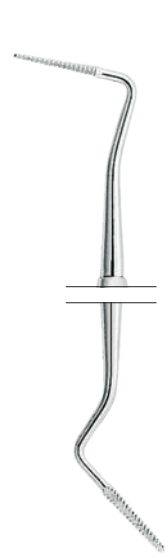

1S/2S Sugarman
1812-02S
Asa60
MV1812-02S
Asa Light MV

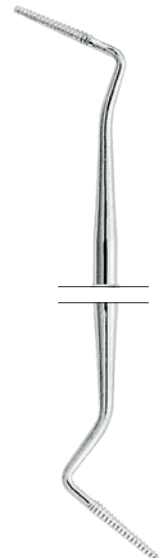

3S/4S Sugarman
1812-04S
Asa60
MV1812-04S
Asa Light MV

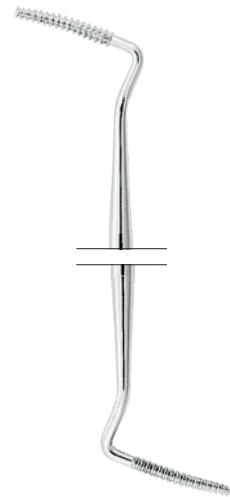

9/10 Schluger
1813-10
Asa60
MV1813-10
Asa Light MV

1812-04S



1 Polokoff
2003-1



33
2004-33



12 Howard
2008-12



45 Miller
2005-45



12A
2007-12A



64 Miller
2005-64



12CA
2007-12CA



10
2006-10

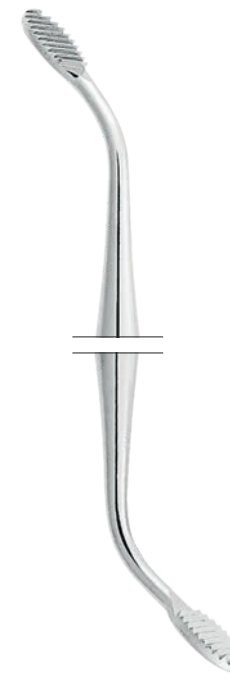

1 Wahl
MV2002-1
Asa Light MV

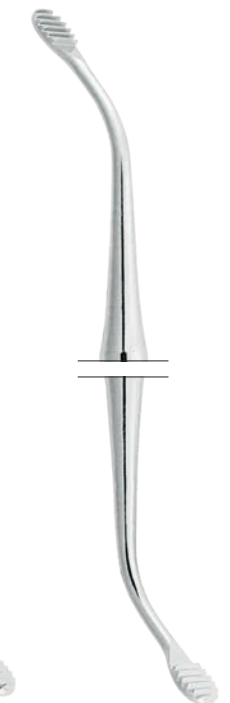

2 Wahl
MV2002-2
Asa Light MV

Bisturi per gengivectomia

Bisturi per gengivectomia



1 (15K) Kirkland
1803-1
Asa60



2 (16K) Kirkland
1803-2
Asa60



1/2 (15K/16K) Kirkland
1803-D
Asa60
MV1803-D
Asa Light MV
ML1803-D
Leonardo ML



1 Orban
1804-1
Asa60

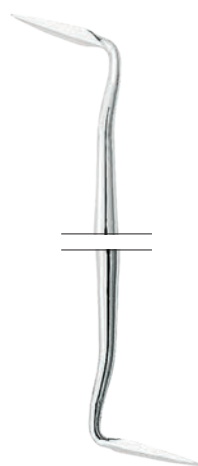

5/6 Buck
1816-06
Asa60
ML1816-06
Leonardo ML



2 Orban
1804-2
Asa60



1/2 Orban
1804-D
Asa60
MV1804-D
Asa Light MV
ML1804-D
Leonardo ML



7 Goldman-Fox
1815-7
Asa60

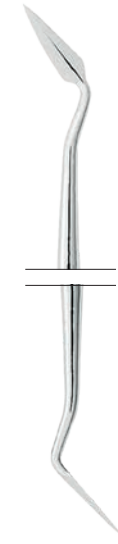

8 Goldman-Fox
1815-8
Asa60



1/2 Sanders
1817-02
Asa60

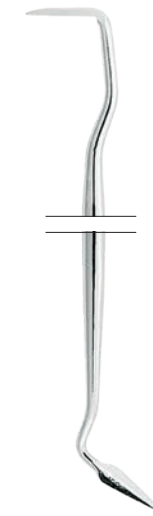

9 Goldman-Fox
1815-9
Asa60

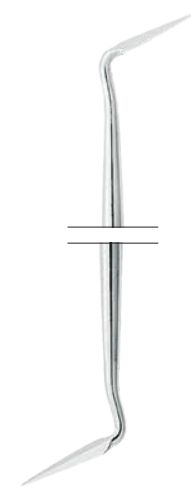

4/5 Sanders
1817-05
Asa60

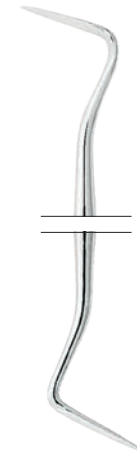

11 Goldman-Fox
1815-11
Asa60



19/20
(University of
South California)
USC Towner
1818-20
Asa60

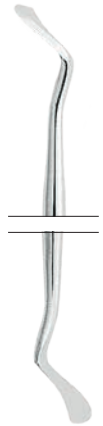

3/4 Buck
1816-04
Asa60



CK3 Crane-Kaplan
1819-CK3
Asa60

Scalpellini chirurgici

Scalpellini e sgorbie per parodontologia



3 Ochsenbein
1802-3
Asa60
MV1802-3
Asa Light MV

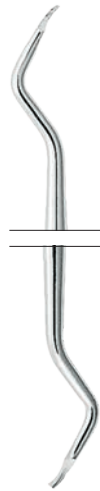

4 Ochsenbein
1802-4
Asa60
MV1802-4
Asa Light MV

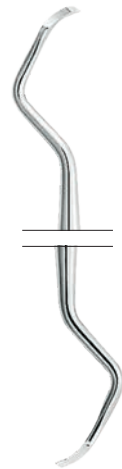

36/37 Rhodes back-action
1811-37
Asa60
MV1811-37
Asa Light MV



1 TG Chisel
1801-1
Asa60



2 TG Chisel
1801-2
Asa60



1/2 TG Chisel
1801-D
Asa60
MV1801-D
Asa Light MV



1 Ochsenbein
1800-1



2 Ochsenbein
1800-2



6 Gardner
1832-6



1 Gardner
1832-1



1W Wakefield
1833-1W



2 Gardner
1832-2



2W Wakefield
1833-2W



5 Gardner
1832-5



3 Buckley
1834-3



5R Gardner
1832-5R

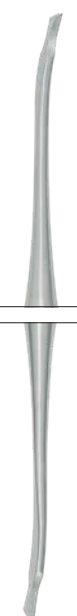

17 cm
PR1801-1
Perfection

Scalpellini e sgorbie per parodontologia

3 mm



Partsch
13,5 cm
1835-3

4 mm



Partsch
13,5 cm
1835-4

5 mm



Partsch
13,5 cm
1835-5

6 mm



Partsch
13,5 cm
1835-6

3 mm



Partsch
13,5 cm
1837-3

4 mm



Partsch
13,5 cm
1837-4

5 mm



Partsch
13,5 cm
1837-5

6 mm



Partsch
13,5 cm
1837-6

3 mm



Partsch
17 cm
1836-3

4 mm



Partsch
17 cm
1836-4

5 mm



Partsch
17 cm
1836-5

6 mm



Partsch
17 cm
1836-6

3 mm



Partsch
17 cm
1838-3

4 mm



Partsch
17 cm
1838-4

5 mm



Partsch
17 cm
1838-5

6 mm



Partsch
17 cm
1838-6

Martelli chirurgici

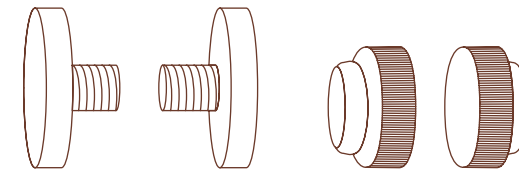

1881-R
coppia inserti di ricambio
in Teflon autoclavabili
max 120°

inserti
intercambiabili
in ferrozell



Partsch
19 cm
1880
con piombo

Mead
19,5 cm
1881

Mead
17 cm
1882

Vickers
19 cm
1884

Herbert
19 cm
1885

Strumenti per parodontologia

Pinzette per marcare le tasche



Tomati
19 cm
0103-78
ulocistotomo



Goldman-Fox
10 cm
0103-60
pinza per tessuti
dimensioni ridotte per accesso
in aree molto limitate



Mini Friedman
12 cm
0103-25
pinza ossivora

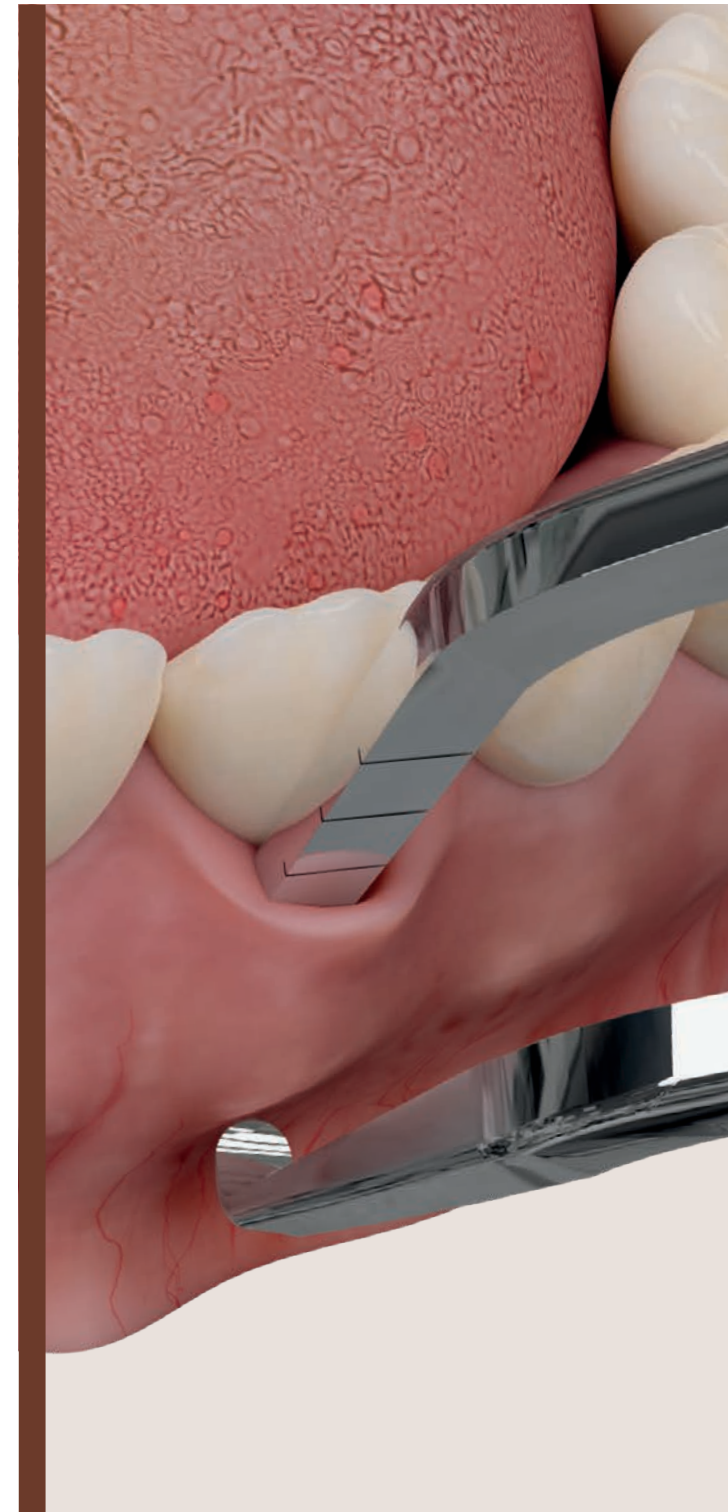

0650-2



1 (Crane-Kaplan)
Goldman-Fox
15 cm
0650-1

2 (Crane-Kaplan)
Goldman-Fox
15 cm
0650-2

Pietre per affilare

pietre in corindone India, beige, per affilare gli strumenti molto smussati

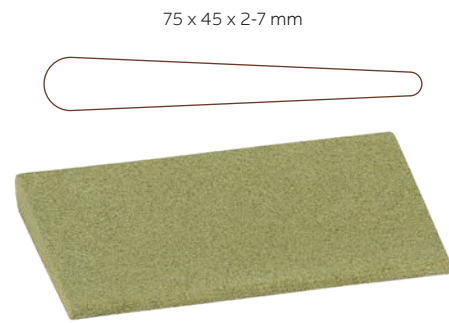

grana fine
1890-1F

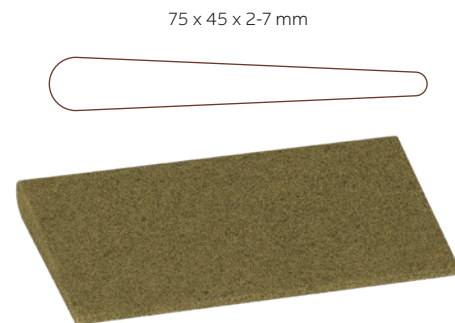

grana media
1890-1M



pietra per affilare "Arkansas" bianco grigiastro, per l'affilatura ripetuta e la finitura degli strumenti levatartaro e delle curette

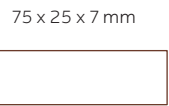

1890-2

pietra per affilare Super "Arkansas", bianca, per affilatura ripetuta e finitura degli strumenti levatartaro e delle curette

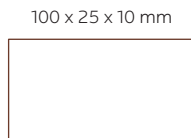

1890-3

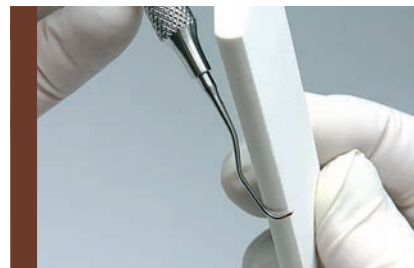

pietra Arkansas con bordo convesso per rifinire l'affilatura

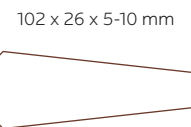

1890-4

pietre per affilare India, in corindone, lima rotonda, beige scuro, per togliere sbavature dalle estremità



1890-5

Pietre per affilare



pietra per affilare "Arkansas", lima rotonda, bianca grigiastro, per togliere sbavature dalle estremità

100 mm x max Ø 10 mm



1890-6

pietra per affilare in carburo di silicio, conica, verde, per togliere sbavature dall'estremità

102 x 8 mm - 15 x 2 - 6 mm



1890-7



barra di prova di plexiglass per controllare l'efficienza del taglio degli strumenti levatartaro e delle curette 6 pz / confezione

100 mm x max Ø 10 mm



1891-1



155 x 80 x 120 mm

S1890

cassetta con supporti completa di pietre per affilare e olio.



Asa Oil
40 ml
8001

olio per affilatura strumenti, non dannoso fisiologicamente

Curette Gracey

set da 3



08 · 12 · 14
S1807-3
Asa60

set da 7



02 · 04 · 06 · 08 · 10 · 12 · 14
S1807
Asa60
SMV1807
Asa Light MV
SML1807
Leonardo ML
SLV1807
Leonardo Light LV
SMC1807
Magic Color MC

set da 3



08AF · 12AF · 14AF
S1807AF-3
Asa60

set da 7



02AF · 04AF · 06AF · 08AF
12AF · 14AF · 16AF
S1807AF
Asa60
SML1807AF
Leonardo ML
SLV1807AF
Leonardo Light LV

set da 3



08MF · 12MF · 14MF
S1807MF-3
Asa60

set da 7



02MF · 04MF · 06MF · 08MF
12MF · 14MF · 16MF
S1807MF
Asa60
SML1807MF
Leonardo ML
SLV1807MF
Leonardo Light LV

Kit di strumenti per parodontologia

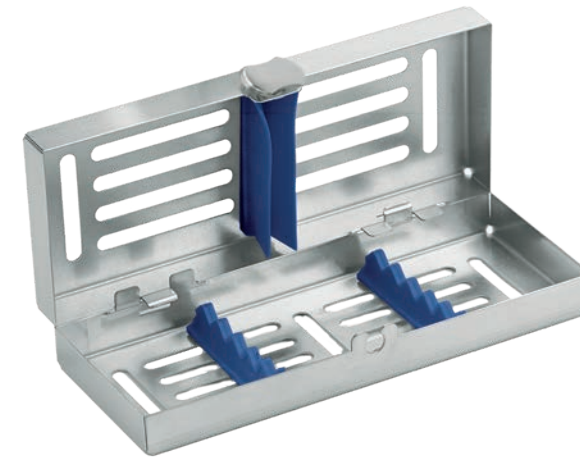

SMC1807-5



1/2	curette Gracey	MC1807-02
11/12	curette Gracey	MC1807-12
13/14	curette Gracey	MC1807-14
6S	curette mini Crane-Kaplan	MC1829-CK6S
U15/33	scaler Towner-Jaquette	MC1902-1
2	pinzetta per medicazione London-College	0601-2
	mini cassetta portastrumenti	2772-1



S1899

2	forbicina Goldman-Fox curva	0304-2
1	pinzetta per marcare le tasche Goldman-Fox destra	0650-1
2	pinzetta per marcare le tasche Goldman-Fox sinistra	0650-2
	sonda millimetrica parodontale Williams	0703L-1
15K/16K	bisturi per gengivectomia Kirkland	1803-D
1/2	bisturi per gengivectomia Orban	1804-D
5/6	curette Gracey	1807-06
11/12	curette Gracey	1807-12
13/14	curette Gracey	1807-14
1	scaler Goldman-Fox	1809-1
5/6	bisturi per gengivectomia Buck	1816-06
13/14	Mc Call scaler	1825-14
6	scaler Crane-Kaplan	1829-CK6
U15	scaler Towner	1903
M9	scollaperiosteo Molt	MV1850-M9

Strumenti per parodontologia

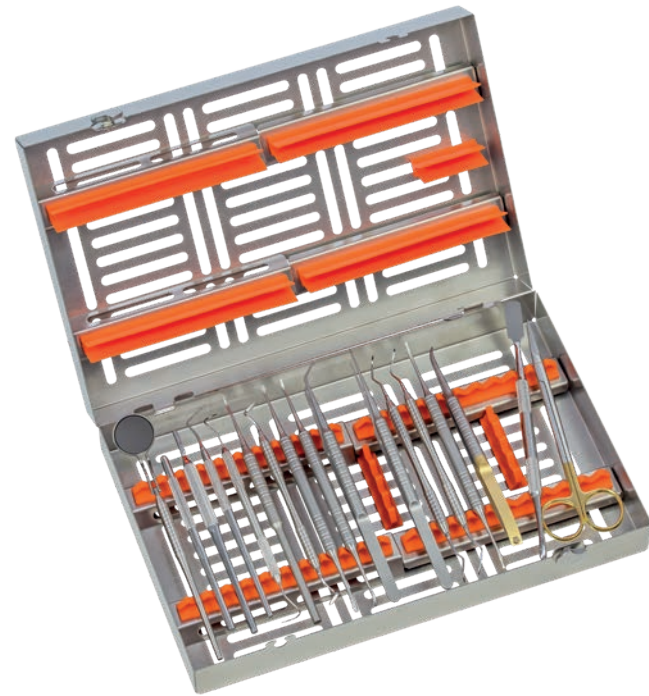

Kit chirurgia parodontale
SPR2781-P

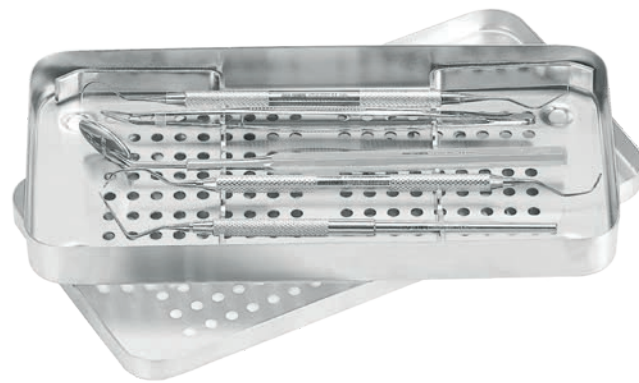

Kit prima visita parodontale
S0600-1



S3003-9

	manico per specchietti	ML2101
5	specchietto doppio	22305
CP-15	sonda millimetrica parodontale	0702L-15
2N	sonda doppia millimetrica parodontale	0708L-2N
	manico per micro lame	0365-1
5	manico per bisturi e lama	0350-5
	dissetto	PR1857-1
1/2	bisturi per gengivectomia Orban	ML1804-D
PR3	scollaperiostio Prichard	MV1851-PR3
	scollaperiostio	PR1850-M
	scollapapilla	PR1850-1
	pinzetta per sutura	PR0625-3
	pinzetta chirurgica atraumatica	PR0632-1
2R/2L	strumento parodontale	ML1806-2RL
4R/4L	strumento parodontale	ML1806-4RL
	scalpello da osso	PR1801-1
	porta aghi Castroviejo	PR0460-15TC
2TC	forbicina per gengive	0309-2TC
	cassetta portastrumenti	2780-1A

	manico per specchietti	2102-IN
4	specchietto piano	2200-4
23/17	sonda doppia	0704-23D1
1N	sonda parodontale	0708-1N
CP-12	sonda millimetrica parodontale	0702L-12
2	pinzetta per medicazione London-College	0601-2
	vassoio	S2702

M9	scollaperiostio Molt	MV1850-M9
PR3	scollaperiostio Prichard	MV1851-PR3
GF	scollaperiostio Goldman-Fox	MV1850-GF
15K/16K	bisturi Kirkland	MV1803-D
	martello Mead	1881
	porta aghi Castroviejo	0446-14TC
	porta aghi Mathieu	0435-17TC
3	manico per bisturi	0350-3
	vassoio	S2722-1

Strumenti per parodontologia



S3003-11

Set di strumenti realizzato secondo le indicazioni del Prof. GUIDO GORACCI, titolare della Cattedra di Odontoiatria Conservatrice presso l'Università degli studi di Roma "La Sapienza"



S1800-23

3	manico per bisturi	0350-3
	divaricatore Sternberg	2602-1
2	forbicine Goldman-Fox	0304-2
M9	scollaperiostio Molt	MV1850-M9
PR3	scollaperiostio Prichard	MV1851-PR3
	porta aghi Crile-Wood	0415-15TC
1	pinzetta chirurgica Semken Taylor	0631-1
23	sonda	0700-23
	manico per specchietto	2102-IN
5	specchietto piano	2200-5
11	lame per bisturi (100 pz)	0351-11
	vassoio	S2722-1

36/37	lima Rhodes back-action	1811-37
15K	bisturi Kirkland	1803-1
3/4	bisturi Buck	1816-04
7	bisturi Goldman-Fox	1815-7
1/2	bisturi Sanders	1817-02
HU 1/2	curette Langer	1805-02
5/6	scaler Bernhart	1821-06
3/4	scaler Rule	1823-R04
1	scaler De Marco	1808-1
5	scaler Goldman-Fox	1809-5
6	scaler Goldman-Fox	1809-6
11/12	curette McCall	1825-12
11A/12A	curette McCall	1825-12A
204	curette	1827-204
31/32	curette Jacquette	1831-32
H5/33	curette	1904-H5
3/7	lima Hirschfeld	1810-07
1S/2S	lima Sugarman	1812-02S
3S/4S	lima Sugarman	1812-04S
1/2	scalpello	1801-D
2	scaler De Marco	1808-2
2	bisturi Kirkland	1803-2
4	scalpello Ochsenbein	1802-4
	vassoio	S2720-2



ORTODONZIA

MADE IN ITALY

LA QUALITÀ AL GIUSTO PREZZO

Ogni specialista, indipendentemente dal tipo di intervento da attuare, necessita di strumenti e apparecchiature affidabili che permettano di lavorare con tranquillità ed efficacia. A tal proposito, noi di Asa Dental offriamo due diverse linee di prodotti: la prima, la linea standard, è composta da strumenti che offrono il compromesso ottimale tra prezzo e prestazioni ed è stata progettata come gamma di prodotti accessibile a tutti. La seconda, la linea premium, è una varietà di strumenti che si rivolge a quei professionisti che richiedono ergonomia e qualità ai massimi dell'eccellenza in qualsiasi circostanza. Perché crediamo nell'eccellenza e ambiamo alla perfezione, ma desideriamo, in primis, che tutti possano accedere a cure dentali di qualità.

- H4 Tronchesi
- H10 Pinze per piegare fili
- H29 Pinze di utilità
- H34 Strumenti per ortodonzia
- H37 Contenitori per protesi

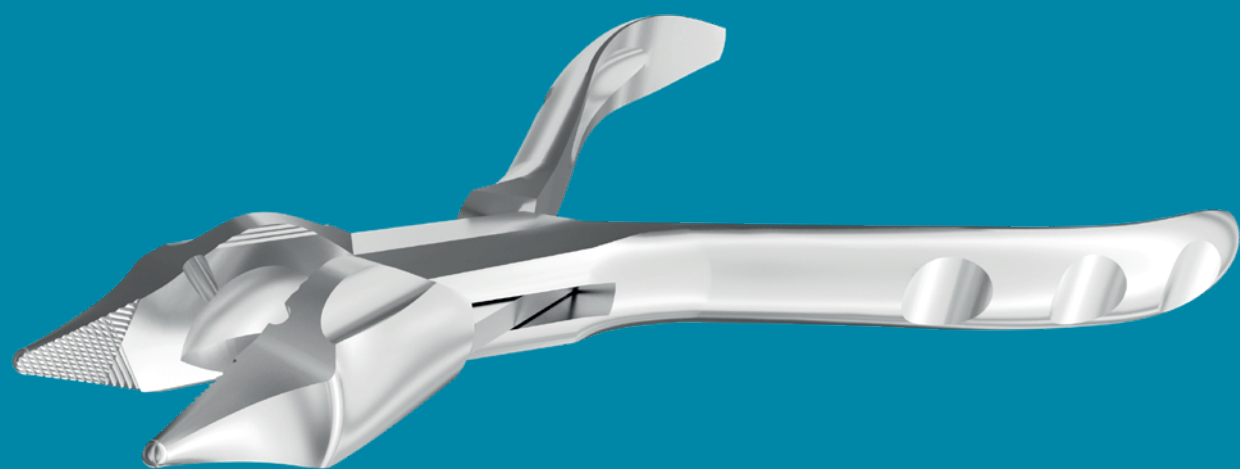

Come leggere questo capitolo



strumento Premium per ortodonzia



strumento Premium per ortodonzia con inserti al carburo di tungsteno (TC)



strumento standard



strumento standard con inserti al carburo di tungsteno (TC)

Come usare le informazioni

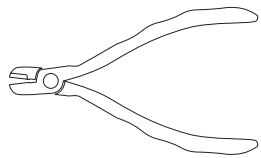

vista intera
strumento Premium per ortodonzia
codice con prefisso 88

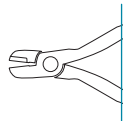

vista parziale
strumento standard
codice con prefisso 58

quando la vista intera e quella parziale compaiono nella stessa pagina, lo strumento è disponibile sia nella versione Premium che in quella standard

Disegno tecnico



i disegni forniscono dettagli aggiuntivi sulla forma di uno strumento

Tronchesi



tronchese per filo duro a 15°
8812-2TC

L'inclinazione a 15° permette di raggiungere agevolmente le zone di difficile accesso.

Dimensioni del filo:
max. 0,56 mm x 0,70 mm
(0,022" x 0,028")

Tronchesi



tronchese distale a taglio netto
8826-1TC

Tronchese distale a taglio netto con inserti in metallo duro.
Dimensioni del filo: max. 0,56 mm x 0,70 mm
(0,022" x 0,028")



tronchese distale universale senza trattenuta del filo
8813-1TC

Tronchese distale universale Mini, senza trattenuta del filo.
Taglio preciso di bracket e tubi boccali.
Dimensioni del filo: max. 0,56 mm x 0,70 mm
(0,022" x 0,028")



tronchese distale universale
8814-1TC

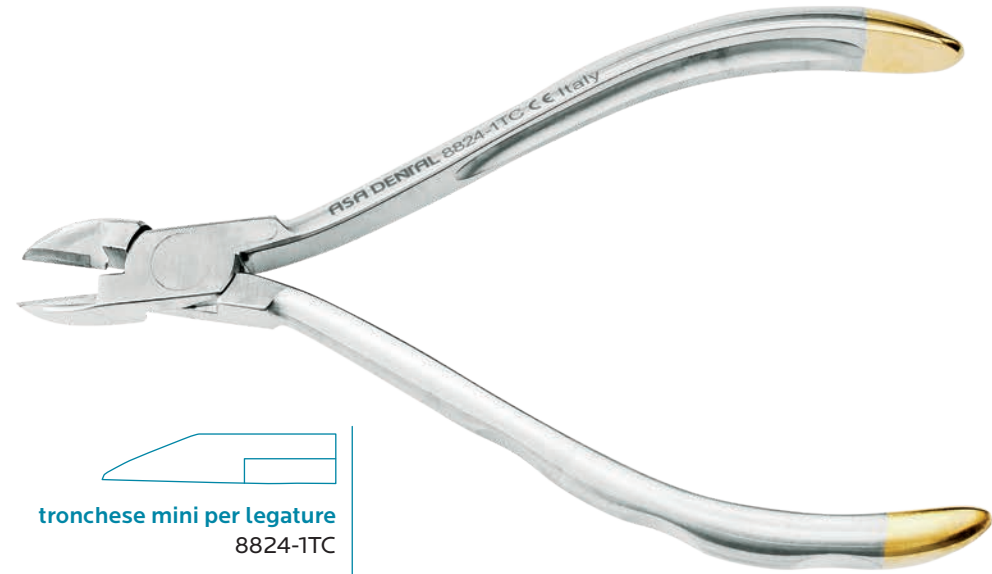

Tronchese distale universale Mini, con trattenuta del filo per garantire la sicurezza e il comfort del paziente durante l'uso.
Dimensioni del filo: max. 0,56 mm x 0,70 mm
(0,022" x 0,028")

Tronchesi

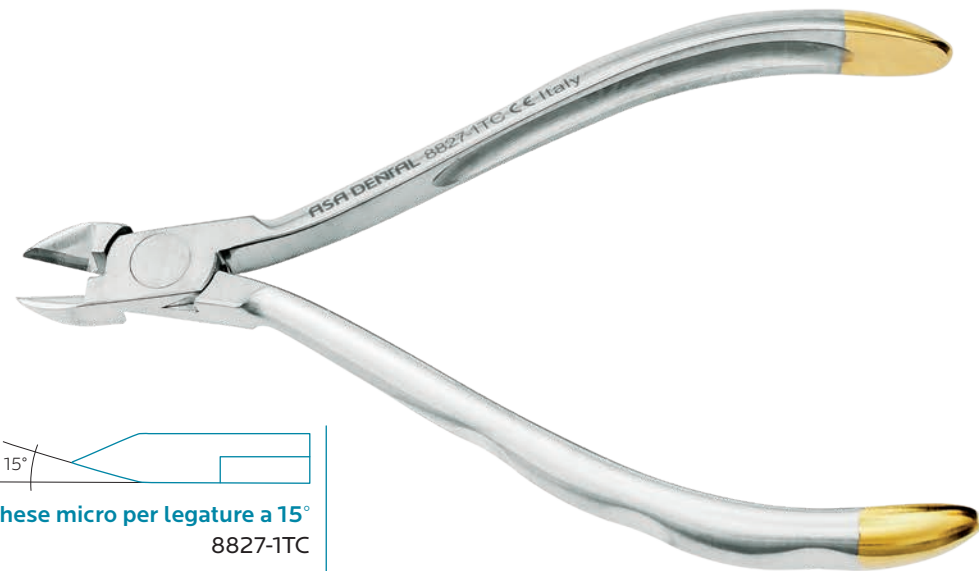

tronchese mini per legature
8824-1TC

Tronchese Mini per legature, dritta.
Profilo ultrasottile per raggiungere agevolmente le zone di difficile accesso.
Dimensioni filo: max. 0,40 mm (0,015")

tronchese micro per legature a 15°
8827-1TC

Tronchese Micro per legature e taglio di filo duro, con lama inclinata a 15°.
Profilo ultrasottile per raggiungere agevolmente le zone di difficile accesso.
Dimensioni filo: max. 0,40 mm (0,015")

Tronchesi

tronchese multiuso
8812-1TC

Tronchese versatile per il taglio di filo duro.
Dimensioni filo: max. 0,56 mm x 0,70 mm
(0,022" x 0,028")



tronchese multiuso
5832



tronchese multiuso
5832-1TC

Stesse caratteristiche del 5832 con l'aggiunta di inserti in carburo di tungsteno

Tronchesi



tronchese micro
5833

Tronchese per legature micro, adatto per filo morbido.
Profilo ultrasottile per raggiungere agevolmente
le zone di difficile accesso.
Dimensioni filo: max. 0,30 mm (0,012")



tronchese micro
5833-1TC

Stesse caratteristiche del 5833
con l'aggiunta di inserti in carburo di tungsteno



tronchese per filo <= 0,9 mm
5880-1

Tronchese per filo duro, adatto a legature e perni di bloccaggio.
Consente di piegare le estremità del filo dopo il taglio distale.
Dimensioni filo: max. 0,9 mm (0,036")



tronchese per filo <= 1,5 mm
5880-2

Tronchese per filo duro, adatto a legature e perni di bloccaggio.
Consente di piegare le estremità del filo dopo il taglio distale.
Dimensioni filo: max. 1,5 mm (0,044")

Tronchesi



tronchese per filo <= 1,2 mm
5880-3TC

Tronchese per filo duro, adatto a legature e perni di bloccaggio.
Consente di piegare le estremità del filo dopo il taglio distale.
Dimensione del filo: max. 1,2 mm (0,044").
Con inserti in carburo di tungsteno



tronchese per taglio distale
5836

Tronchese distale per filo duro, con trattenuta del filo per
garantire la sicurezza e il comfort del paziente durante l'uso.
Dimensioni del filo: sezione rettangolare max. 0,56 mm x 0,7 mm
(0,022" x 0,028")
sezione circolare max. 0,5 mm (0,020")



tronchese per taglio distale
5836-1TC

Stesse caratteristiche del 5836-1TC
con l'aggiunta di inserti in carburo di tungsteno



tronchese per taglio distale micro
5837

Tronchese distale per filo duro, con trattenuta del filo per
garantire la sicurezza e il comfort del paziente durante l'uso.
Dimensioni del filo: sezione rettangolare max. 0,56 mm x 0,7 mm
(0,022" x 0,028")
sezione circolare max. 0,5 mm (0,020")

Pinze per piegare fili

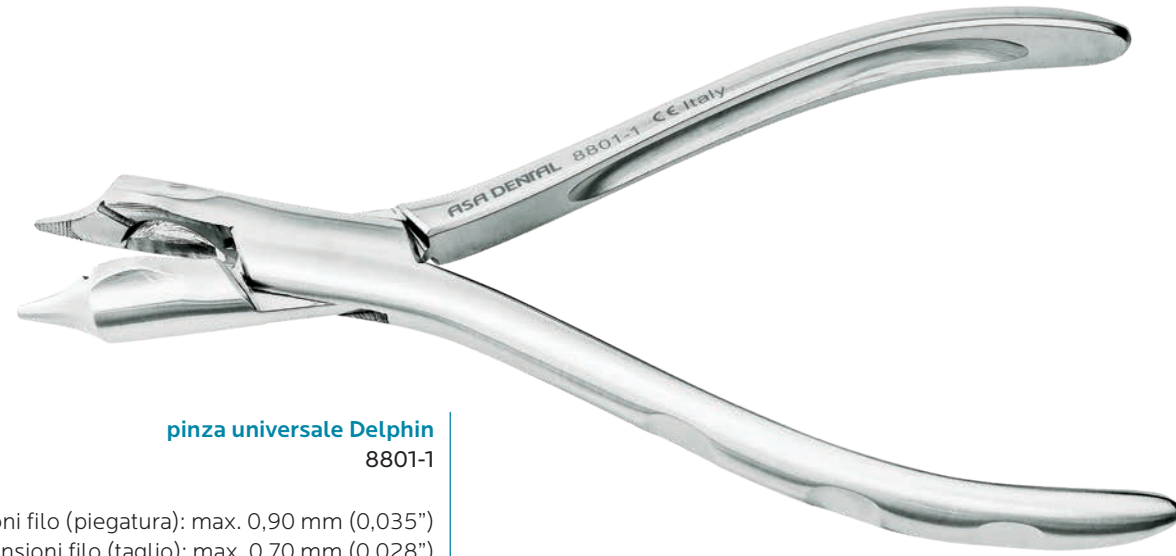

pinza universale Delphin
8801-1

Dimensioni filo (piegatura): max. 0,90 mm (0,035")
Dimensioni filo (taglio): max. 0,70 mm (0,028")



pinza universale Delphin
5801-1



pinza universale
8801-2

Dimensioni filo (piegatura): max. 0,90 mm (0,035")
Dimensioni filo (taglio): max. 0,70 mm (0,028")



pinza universale
5801-3

Pinze per piegare fili



pinza Waldsachs
8802

Dimensioni filo (piegatura): max. 0,90 mm (0,035")
Dimensioni filo (taglio): max. 0,70 mm (0,028")



pinza Waldsachs
5802



3 mm (0,118")
4 mm (0,157")
5 mm (0,197")
6 mm (0,236")



pinza di precisione Nance
8816

Per la creazione di anelli precisi in
4 diverse misure: 3, 4, 5 e 6 mm.
La scanalatura alla base favorisce
la chiusura degli anelli.
Dimensioni filo: max. 0,70 mm (0,028")

Pinze per piegare fili

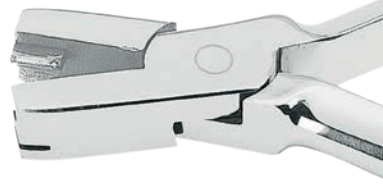

pinza Nance
5800

Pinza per la chiusura loop, per la formazione di stop su archi e per la formazione di ganci Adams.
Dimensioni filo: max. 0,7 mm (0,028")



pinza concava-convessa
5806

Pinza con un becco concavo e uno tondo per la formazione di pieghe ad ansa e loop su fili sottili a sezione quadrata e circolare.
Dimensioni filo: max. 0,5 mm (0,020")



pinza Tweed
5809-1

Pinza Tweed per la formazione di loop su fili a sezione quadrata e circolare, con becco cilindrico sostituibile a tre sezioni. Il becco concavo ha dentellature parallele per mantenere il filo in posizione.
Dimensioni filo: max. 0,56 x 0,7 mm (0,022"x 0,028")
Dimensioni becco: 1,15 mm (0,045"), 1,50 mm (0,059"), 1,90 mm (0,075")

Pinze per piegare fili

1,20 mm (0,047")
1,60 mm (0,063")
2,00 mm (0,075")



pinza Omega Tweed
8804-2

Pinza per la formazione di loop Omega su fili a sezione quadrata e circolare, con becco cilindrico sostituibile a tre sezioni. Il becco concavo ha dentellature parallele per mantenere il filo in posizione.
Dimensioni filo: max. 0,70 mm (0,028")



8804-2P

Punta di ricambio per pinza 8804-2



8804-3P

Vite di ricambio e chiave per pinza 8804-2



pinza Omega Tweed
5809-2

Pinze per piegare fili

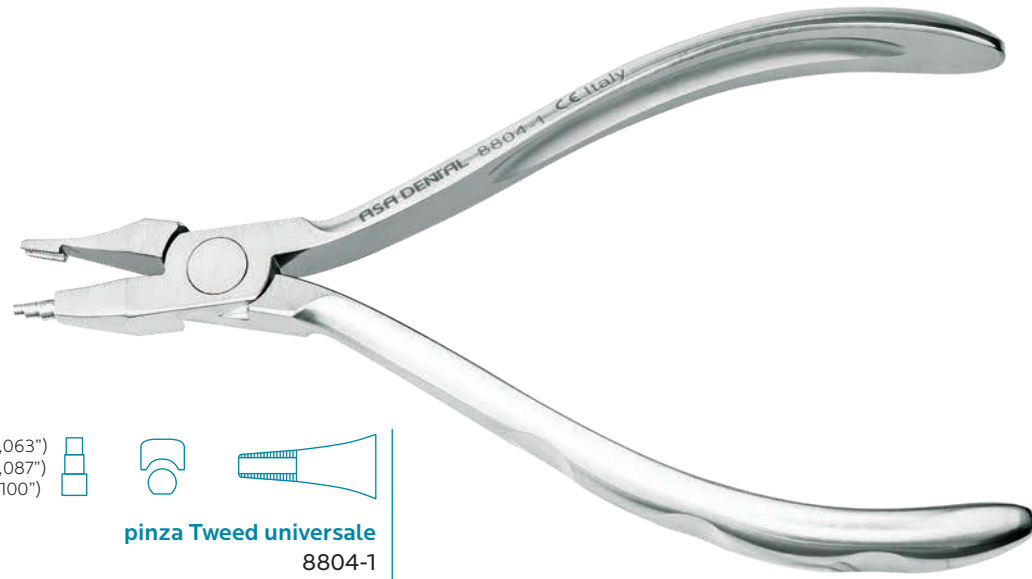

1,60 mm (0,063")
2,20 mm (0,087")
2,80 mm (1,100")

pinza Tweed universale
8804-1

Pinza per la formazione di loop elicoidali e loop di bull con diametri multipli.
Dimensioni filo: max. 0,70 mm (0,028")



pinza Tweed universale
5870

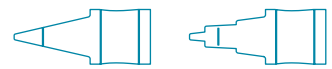

pinza Young
8817

Pinza per la formazione di loop di diverse dimensioni ideale per archi labiali.
Dimensioni filo: max 0,70 mm (0,028")

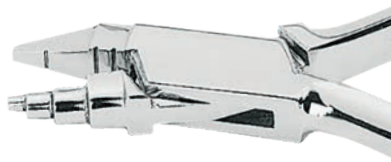

pinza Young
5863

Pinze per piegare fili



pinza Tweed
5809-3

Pinza per la formazione di loop con un becco cilindrico a dimensione fissa e un becco concavo dotato di dentellature.
Dimensioni filo: max. 0,56 x 0,7 mm (0,022" x 0,28")
Dimensioni becco: 1,50 mm (0,059")



pinza Tweed (Angle)
5872-1

Pinza a becchi corti (10mm) per la formazione di archi rettangolari su fili a sezione quadrata e rettangolare.
Le lame risultano parallele ad un'apertura di 0,5 mm (0,020")



3 mm (0,118")
4 mm (0,157")
5 mm (0,197")
6 mm (0,236")

pinza di Nance
5862

Pinza progettata per formare loop in 4 diverse misure su fili a sezione circolare e rettangolare.
Dimensioni filo: max. 0,7 mm (0,028")

Pinze per piegare fili



pinza Reynolds
8805

Pinza per modellazione



pinza Reynolds
5812

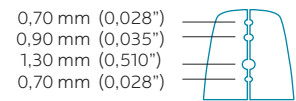

pinza per archi linguali
8807-3

0,76 mm - 0,90 mm (0,030" - 0,036")
Dimensioni filo: max. 0,90 mm (0,036")



pinza per archi linguali
5818

Pinze per piegare fili



pinza per archi mini
8807-1

1,30 mm (0,050")
Dimensioni filo: max. 0,56 mm x 0,64 mm
(0,022" x 0,025")



pinza per archi
8807-2

1,78 mm (0,067")
Dimensioni filo: max. 0,56 mm x 0,64 mm
(0,022" x 0,025")

Pinze per piegare fili

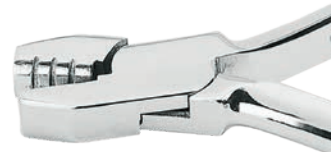

pinza De La Rosa con guide
5821-1

Pinza per formare archi e modellare contorni su fili a sezione circolare e rettangolare. Le misure delle guide sul becco sono di 0,4 mm (0,016"), 0,46 mm (0,018") e 0,56 mm (0,022")



pinza De La Rosa senza guide
5821-2

Pinza per formare archi e modellare contorni su fili a sezione circolare e rettangolare, priva di guide



pinza Mc Kellops
5860-1

Pinza concava-convessa per filo duro, adatta per formare loop su fili da ganci o per archi labiali. Dimensioni filo: max. 0,8 mm (0,032")



pinza piatta
5864

Pinza con punte piatte per piegare fili. Dimensioni filo: max. 0,9 mm (0,036")

Pinze per piegare fili



pinza a punte coniche corte
5865

Pinza a punte coniche per piegare fili e per ganci. Dimensioni filo: max. 0,7 mm (0,028")



pinza a punte coniche lunghe
5868

Pinza a punte coniche per piegare fili e per ganci. Dimensioni filo: max. 0,7 mm (0,028")



pinza Angle
5866

Pinza Angle a becco d'uccello per piegare fili a sezione circolare, quadrata e rettangolare. Dimensioni filo: max. 0,7 mm (0,028")



pinza Angle con lama
5838

Pinza Angle a becco d'uccello per piegare e tagliare fili a sezione circolare, quadrata e rettangolare. Dimensioni filo: max. 0,7 mm (0,028")

Pinze per piegare fili



pinza Adams
8819

Pinza progettata per piegare fili a 90°



pinza Adams
12,2 cm
5867-1

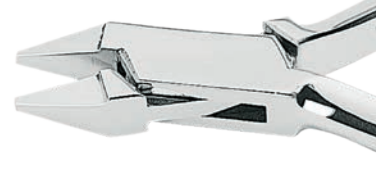

pinza Adams
14,2 cm
5867-2



pinza Johnson
8815

Pinza per contornare corone e bande



pinza Johnson
5861

Pinze per piegare fili



pinza Aderer mini
8820-1

Pinza a tre punte corte per piegare fili
Dimensioni filo: max. 0,50 mm (0,020")



pinza Aderer mini
5869-1



pinza Aderer standard
8820-2

Pinza a tre punte corte per piegare fili
Dimensioni filo: max. 0,70 mm (0,028")



pinza Aderer standard
5869-2

Pinze per piegare fili

□
○



pinza a becco d'uccello universale
8818

Pinza versatile per la formazione di loop

□
○



pinza a becco d'uccello
8821

Pinza a becco d'uccello per filo sottile con scanalatura. Il cono più lungo agevola la creazione precisa di loop, la scanalatura facilita il posizionamento e la duplicazione di loop. Dimensioni filo: max. 0,70 mm (0,028")

Pinze per piegare fili





pinza How universale
8822-1

Pinza How, dritta. Le punte zigrinate la rendono ideale per il posizionamento e la rimozione di archi odontotecnici e perni

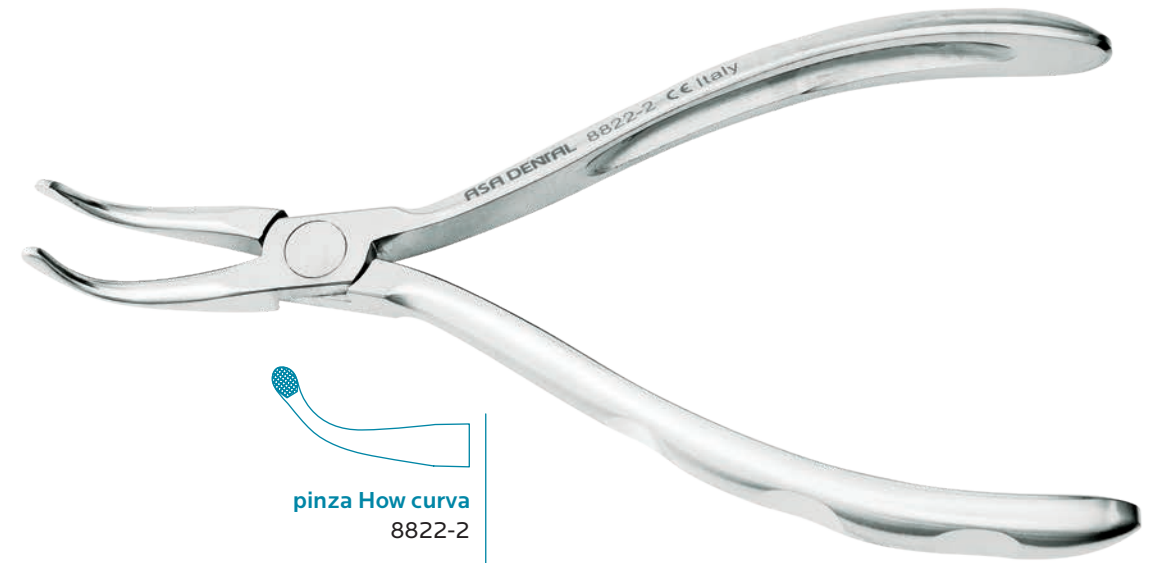

pinza How universale
5874-1



pinza How curva
8822-2

Pinza How, curva. Le punte zigrinate e angolate a 40° la rendono ideale per raggiungere le zone di difficile accesso



pinza How curva
5874-2

Pinze per piegare fili

Δ



pinza a becco d'uccello - filo leggero
5871

Pinza con becchi lunghi progettata per piegare fili a sezione circolare, quadrata e rettangolare. Dimensioni filo: max. 0,4 mm (0,016")



pinza a punte piatte
5875-1

Pinza a punte piatte, sottili e lisce, per qualsiasi piegatura di filo. Dimensioni filo: max. 0,7 mm (0,028")



pinza a punte piatte zigrinate
5875-2

Pinza a punte piatte, sottili e zigrinate, per qualsiasi piegatura di filo. Dimensioni filo: max. 0,7 mm (0,028")



pinza per piegatura - zigrinata
5876-1

Dimensioni filo: max. 0,7 mm (0,028")



pinza per piegatura
5876-2

Dimensioni filo: max. 0,7 mm (0,028")

Pinze per piegare fili



pinza Schwarz
8823

Pinza Schwarz per formare ganci
Dimensioni filo: max. 0,70 mm (0,028")

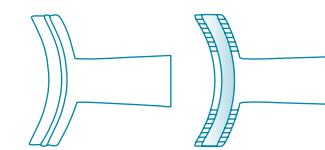

pinza Hammerhead NiTi
8825

Pinza multiuso per piegare fili in NiTi e formare loop senza l'impiego di calore

Pinze per piegare fili



pinza optical
8803

Pinza con scanalatura, ideale per formare loop di chiusura su fili a sezione circolare e rettangolare.
Dimensioni filo: max. 0,70 mm (0,028")

Pinze per piegare fili

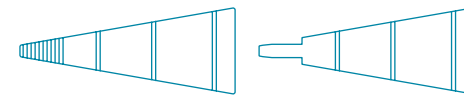

pinza Jarabak
8829

Pinza multiuso per piegare fili leggeri. Le scanalature facilitano la precisione della piegatura e la chiusura dei loop.
Dimensioni filo: max. 0,70 mm (0,028")



pinza hollow chop
8806

Pinza (De La Rosa) indicata per il contorno degli archi.
Dimensioni filo: max. 0,70 mm (0,028")

pinza V-stop
8830

Pinza progettata per creare pieghe a V sugli archi ortodontici, inclusi quelli in nichel titanio, e per prevenire la dislocazione dell'arco.
Dimensioni filo: max. 0,70 mm (0,028")



Pinze per piegare fili

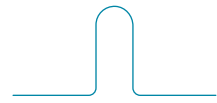

pinza di Nance
8816



pinza Tweed universale
8804-1

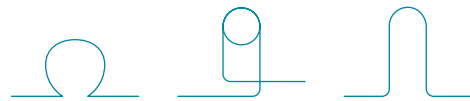

pinza Tweed omega
8804-2



pinza per archi linguali
8807-3



pinza Adams
8819

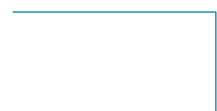

pinza hammerhead NiTi
8825



pinza V-stop
8830



pinza per archi mini
8807-1
pinza per archis
8807-2



pinza Aderer mini
8820-1
pinza Aderer standard
8820-2

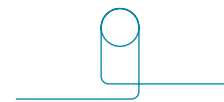

pinza a becco d'uccello universale
8818
pinza a becco d'uccello
8821

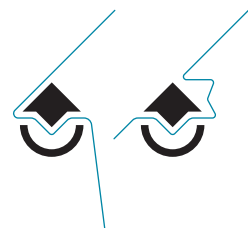

pinza Schwarz
8823

Pinze di utilità



pinza Weingart
8808-1

Pinza ausiliaria Weingart con punte zigrinate, ideale per legature



pinza Weingart
5819



pinza Weingart - slim
8808-2

Pinza ausiliaria Weingart con punte sottili e zigrinate, ideale per legature

Pinze di utilità



pinza togl bracket - becco largo
5826-1

Pinza a becco largo per la rimozione di bracket adesivi. La punta affilata permette di entrare sotto la flangia dell'attacco e ne consente il distacco con estrema facilità, facilitando inoltre la totale rimozione dei residui di materiale adesivo

T

4,4 mm (1/4")
5826-CR1
cuscinetti di ricambio per pinze 5826-1-2, 5828-1-2

T

4,8 mm (3/16")
5826-CR2
cuscinetti di ricambio per pinze 5826-1-2, 5828-1-2



pinza togl attacchi - becco stretto
5826-2

Pinza a becco stretto per la rimozione di bracket adesivi. Funzionalmente simile alla pinza 5826-1



pinza togl bande posteriori - corta
8811-1

Pinza per rimuovere bande e bracket posteriori, corta. La punta è allineata sotto il bordo inferiore del cuscinetto occlusale



8811-1P
ricambio per pinze 8811-1 e 8811-2



pinza togl bande posteriori - corta
5828-1

Pinze di utilità



pinza togl bande posteriori - lunga
8811-2

Pinza per rimuovere bande e bracket posteriori, lunga. La punta è allineata sotto il bordo inferiore del cuscinetto occlusale



8811-1P
ricambio per pinze 8811-1 e 8811-2



pinza togl bande posteriori - lunga
5828-2



pinza togl bracket - larga
8809

Pinza per rimuovere bracket, dritta. Adatta a tutti gli attacchi in acciaio, ceramica e plastica



pinza togl bracket - larga
5824-1

Pinze di utilità



pinza togli bracket - angolata
8810

Pinza per rimuovere bracket, angolata.
Adatta a tutti gli attacchi
in acciaio, ceramica e plastica



pinza togli bracket - angolata
5825



pinza togli adesivo
8831

Pinza per rimuovere
adesivo con lama
reversibile e sostituibile



8831-1P
ricambio per pinza 8831

Pinze di utilità



taglierina universale per bande
8828-1TC

Taglierina per bande.
Dimensioni filo: max. 0,40 mm (0,015")

8828-1TC

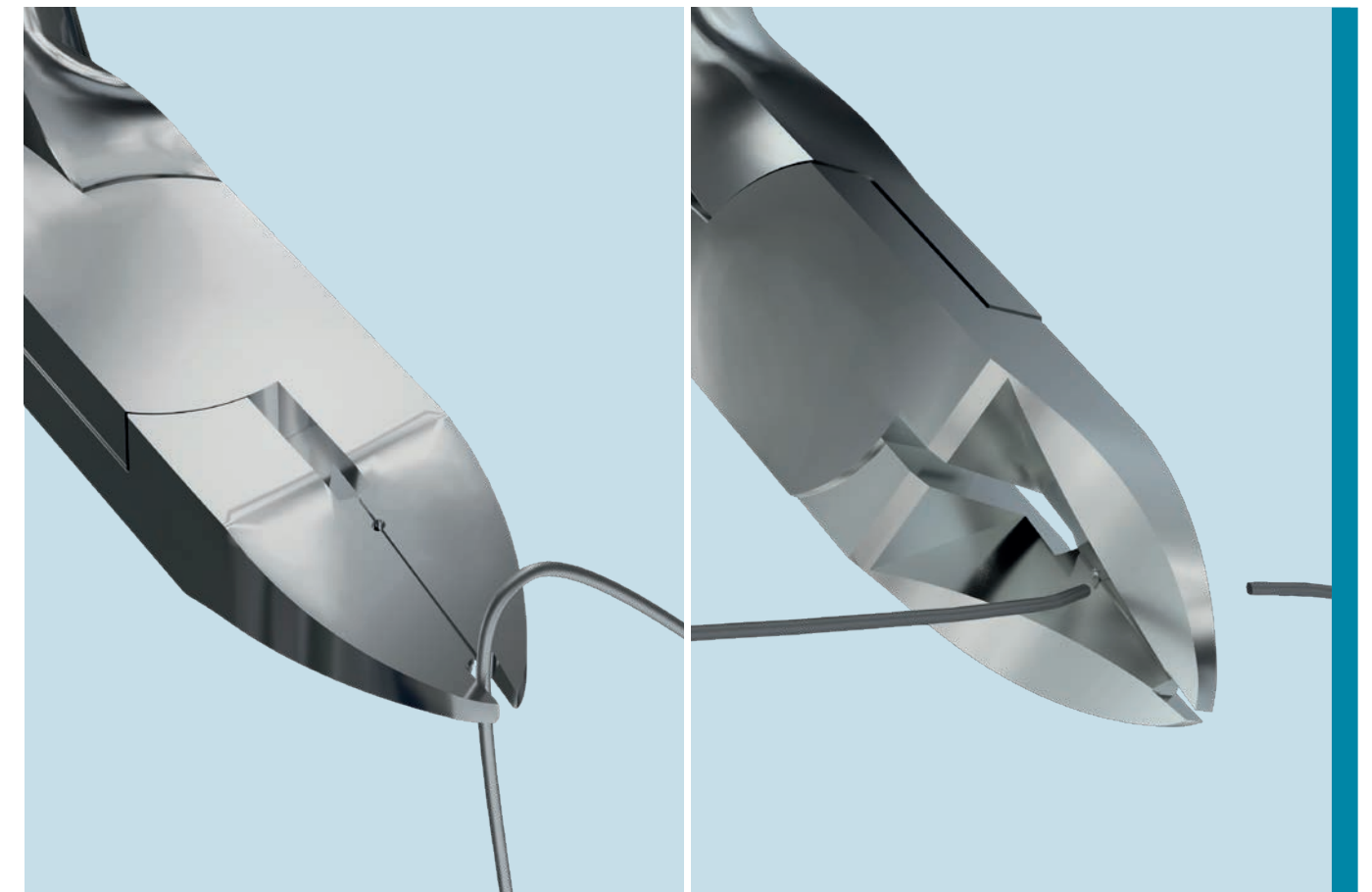

Strumenti per ortodonzia

pinzette per posizionare attacchi adesivi
la presa è automatica e il rilascio avviene soltanto
quando la pinzetta viene premuta.



13,5 cm
2400

13,5 cm
2402

13,5 cm
2401

spingibande



Mershon
14 cm
2410

adattatori di
bande con
inserto di stagno



15 cm
2411

spingibande
sterilizzabile in
autoclave a
vapore saturo



13,5 cm
2412

Strumenti per ortodonzia

strumenti per legature

strumenti per montare
e rimuovere bande



1351-1

1350-1

1350-2

strumento
per elastici



1352-1

pinza tendielastici
per catenelle e separatori



15,5 cm
2450

Strumenti per ortodonzia

marker per il posizionamento di bracket
 misure disponibili 3,5 / 4,0 / 4,5 / 5,0 mm



8832

pinzette per elastici

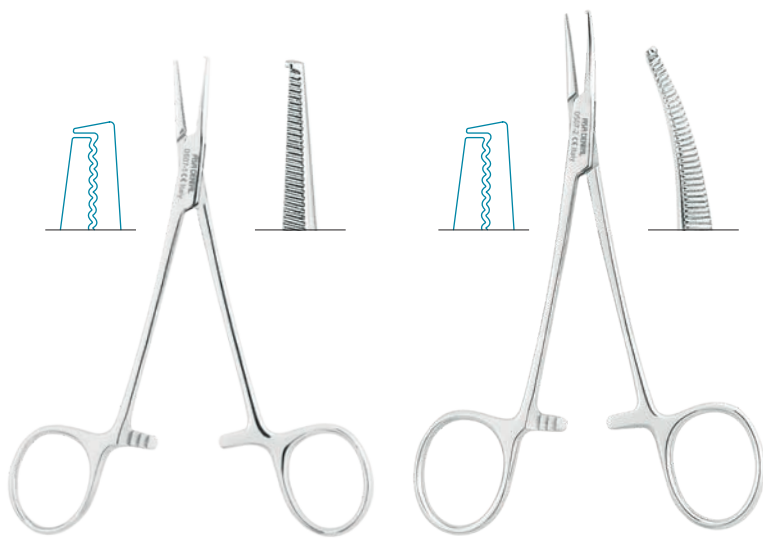

1 Halstead-Mosquito
 retta
 12 cm
 0507-1

2 Halstead-Mosquito
 curva
 12 cm
 0507-2

per legature elastiche

2 mm

3 mm



Luniatschek
 1355-1

Luniatschek
 1355-2

Contenitori per protesi/ortodontici

scatolina in plastica antiurto per apparecchi ortodontici mobili
 10 pz / confezione



Blu
 6900E-A



Bianco
 6900E-B



Celeste
 6900E-C



Giallo
 6900E-G



Rosa
 6900E-R



Verde
 6900E-V



VASSOI E CONTENITORI

MADE IN ITALY

L'EFFICIENZA OPERATIVA, SEMPLIFICATA

Uno studio dentale che cresce per numero di interventi e personale qualificato richiede procedure ancora più efficaci. L'efficienza operativa diventa una conseguenza diretta di una pratica quotidiana ben organizzata, nella quale la gestione ottimale degli strumenti consente di ridurre le perdite di tempo e aumentare la sicurezza dei pazienti. Asa Dental produce vassoi e box che permettono di spostare, sterilizzare e riporre opportunamente tutti gli strumenti che fanno della pratica dei professionisti un supporto irrinunciabile, che si tratti di risolvere problemi estetici o funzionali. Disponibili in diverse misure, forme e materiali, tutti i vassoi dispongono di un vasto set di accessori adatti a suddividere lo spazio interno e bloccare con sicurezza gli strumenti, proteggendo le parti più delicate e i rivestimenti durante le fasi di sterilizzazione.

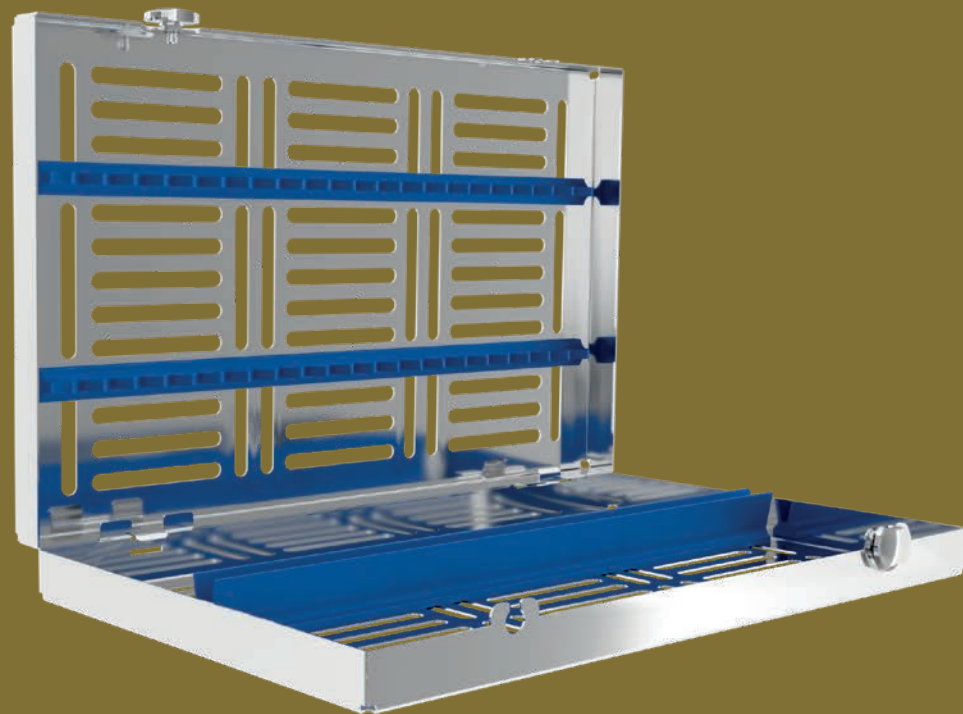

- I2 Cassette in acciaio
- I4 Vassoi in acciaio
- I8 Vassoi in alluminio e accessori
- I12 Lubrificanti per la protezione degli strumenti in autoclave
- I13 Contenitori in alluminio
- I13 Porta vassoi in alluminio
- I13 Pinze per sterilizzazione
- I14 Contenitori per endodonzia
- I17 Porta frese
- I18 Accessori

Cassette portastrumenti in acciaio inox

LARGE
288x182x34 mm

completo di rastrelliera in silicone
per 20 strumenti

- Blu
- 2770-1
- Arancio
- 2770-1A
- Rosso
- 2770-1R
- Verde
- 2770-1V



completo di rastrelliera in silicone
per 15 strumenti

- Blu
- 2770-2
- Arancio
- 2770-2A
- Rosso
- 2770-2R
- Verde
- 2770-2V



completo di rastrelliera in silicone
per 10 strumenti

- Blu
- 2770-3
- Arancio
- 2770-3A
- Rosso
- 2770-3R
- Verde
- 2770-3V



288x182x60 mm

- Arancio
- 2780-1A



MEDIUM
182x144x34 mm

completo di rastrelliera in silicone
per 10 strumenti

- Blu
- 2771-1
- Arancio
- 2771-1A
- Rosso
- 2771-1R
- Verde
- 2771-1V

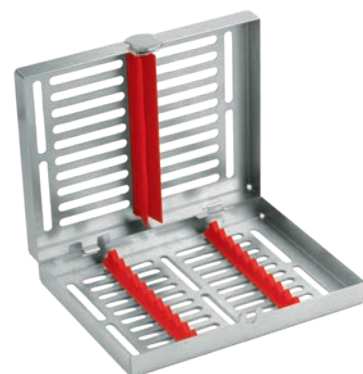

completo di rastrelliera in silicone
per 5 strumenti

- Blu
- 2771-2
- Arancio
- 2771-2A
- Rosso
- 2771-2R
- Verde
- 2771-2V



Cassette portastrumenti in acciaio inox

MINI
182x72x34 mm

completo di rastrelliera in silicone
per 5 strumenti

- Blu
- 2772-1
- Arancio
- 2772-1A
- Rosso
- 2772-1R
- Verde
- 2772-1V

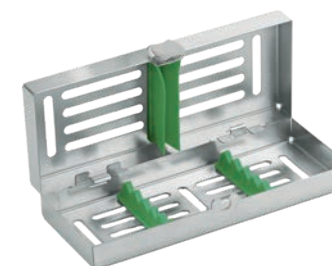

blocca strumenti in silicone
per 10 posti

- Blu
- 2770-G
- Arancio
- 2770-GA
- Rosso
- 2770-GR
- Verde
- 2770-GV



blocca strumenti in silicone
per 5 posti

- Blu
- 2771-G
- Arancio
- 2771-GA
- Rosso
- 2771-GR
- Verde
- 2771-GV



rastrelliera in silicone
per 10 posti

- Blu
- 2772-G
- Arancio
- 2772-GA
- Rosso
- 2772-GR
- Verde
- 2772-GV

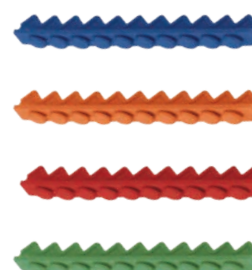

rastrelliera in silicone
per 5 posti

- Blu
- 2773-G
- Arancio
- 2773-GA
- Rosso
- 2773-GR
- Verde
- 2773-GV



serie di 2 pomelli di ricambio
in acciaio completi di rondelle



2774

n° 2 clips per cassette
per forbici

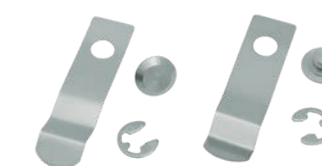
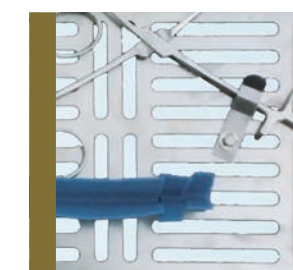

2775

Vassoi portastrumenti in acciaio inox

LARGE
288x187x39 mm

vassoio completo di
base forata, coperchio forato
e griglia

per 16 strumenti
S2722-1

vassoio forato
completo di griglia
per 23 strumenti
S2722-2

288x187x29 mm
coperchio forato
2721-U

284x183x17 mm
base vassoio forata
2721-L



Vassoi portastrumenti in acciaio inox

LARGE
288x187x39 mm

vassoio completo di
base non forata, coperchio non forato
e griglia

per 16 strumenti
S2720-1

vassoio completo di
base non forata, coperchio non forato
e griglia
per 23 strumenti
S2720-2

288x187x29 mm
coperchio non forato
2720-U

284x183x17 mm
base vassoio non forata
2720-L



vassoio completo di
base forata, coperchio non forato
e griglia
per 16 strumenti
S2721-1

vassoio completo di
base forata, coperchio non forato
e griglia
per 23 strumenti
S2721-2

288x187x29 mm
coperchio non forato
2720-U

284 x 183 x 17 mm
base vassoio forata
2721-L



griglia portastrumenti in acciaio inox
per 16 strumenti
2730-1

griglia portastrumenti in acciaio inox
per 23 strumenti
2730-2

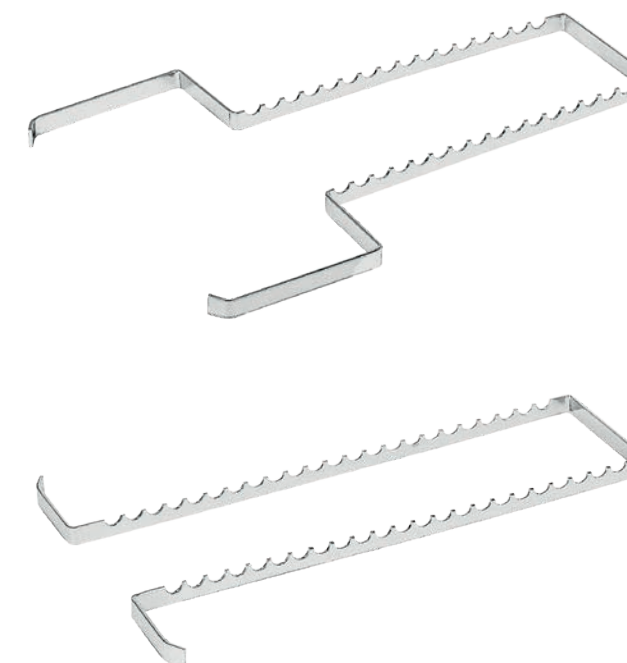

Vassoi portastrumenti in acciaio inox

MEDIUM
200x100x30 mm

vassoio completo di
base forata, coperchio forato
e griglia

per 7 strumenti
S2702

200x100x10 mm
coperchio forato
2702-U

200x100x30 mm
base vassoio forata
2702-L

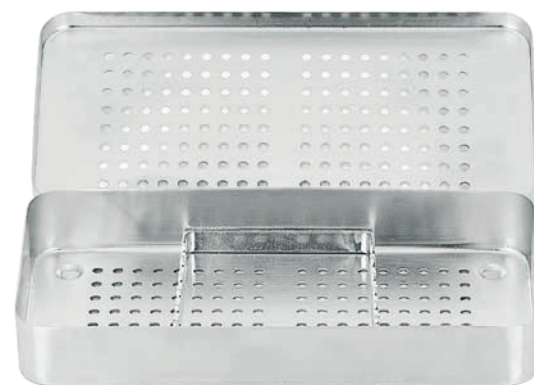

vassoio completo di
base non forata, coperchio non forato
e griglia

per 7 strumenti
S2700

200x100x10 mm
coperchio non forato
2700-U

200x100x30 mm
base vassoio non forata
2700-L

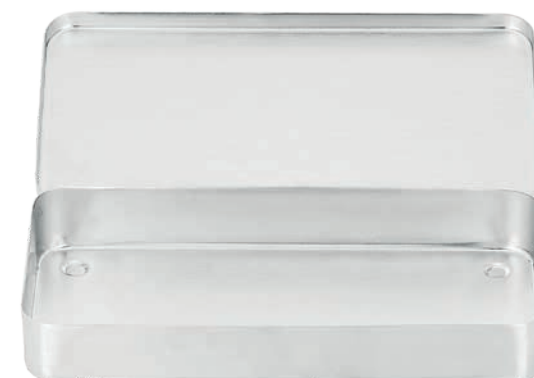

griglia portastrumenti in acciaio inox
per 7 strumenti
2700-G



Vassoi portastrumenti in acciaio inox

MEDIUM
187x144x39 mm

vassoio completo di
base forata, coperchio forato
e griglia

per 8 strumenti
S2723-1

vassoio completo di
base forata, coperchio forato
e griglia

per 4 strumenti
S2723-2

187x144x29 mm
coperchio forato
2723-U

183x142x17 mm
base vassoio forata
2723-L



vassoio completo di
base non forata, coperchio non forato
e griglia

per 8 strumenti
S2724-1

vassoio completo di
base non forata, coperchio non forato
e griglia

per 4 strumenti
S2724-2

187x144x29 mm
coperchio non forato
2724-U

183x142x17 mm
base vassoio non forata
2724-L



griglia portastrumenti in acciaio inox
per 8 strumenti
2730-4



griglia portastrumenti in acciaio inox
per 4 strumenti
2730-5

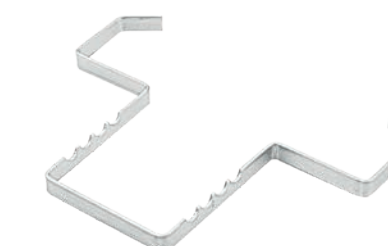

Vassoi portastrumenti in alluminio anodizzato colorato

LARGE
284x183x17 mm

Celeste
AL2720-LC

Rosso
AL2720-LR

Oro
AL2720-LO

Verde
AL2720-LV

Argento
AL2720-LA

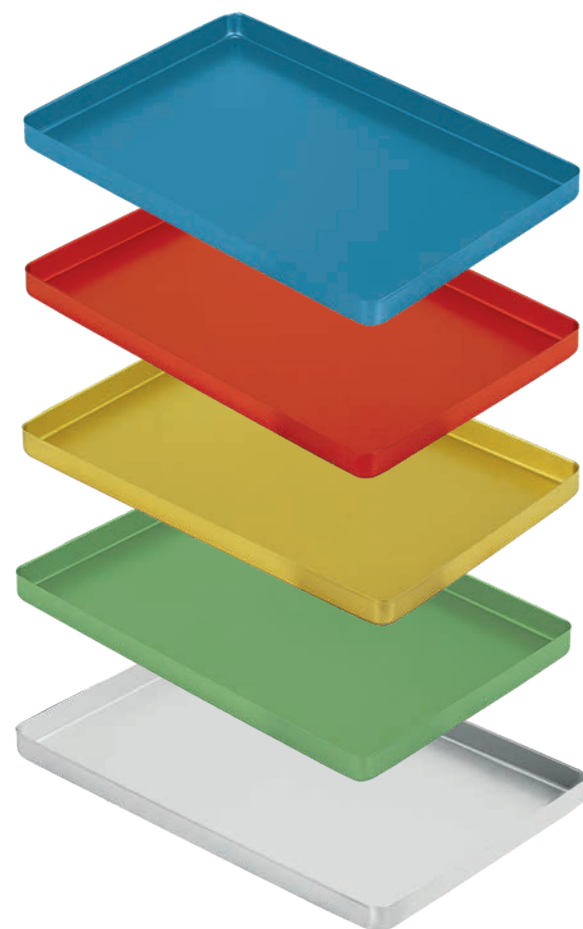

288x187x29 mm
coperchio

Argento
AL2720-UA



Griglie portastrumenti in alluminio

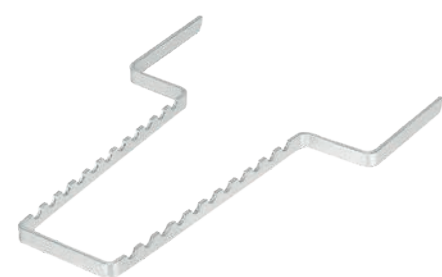

per 11 strumenti
AL2730-1

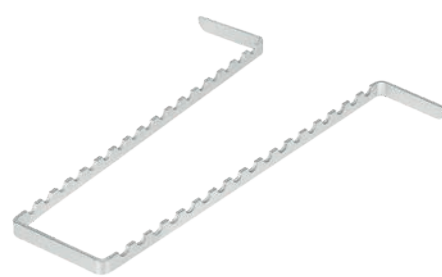

per 17 strumenti
AL2730-2

Vassoi portastrumenti in alluminio anodizzato colorato - forati

LARGE
284x183x17 mm

Celeste
AL2721-LC

Rosso
AL2721-LR

Oro
AL2721-LO

Verde
AL2721-LV

Argento
AL2721-LA

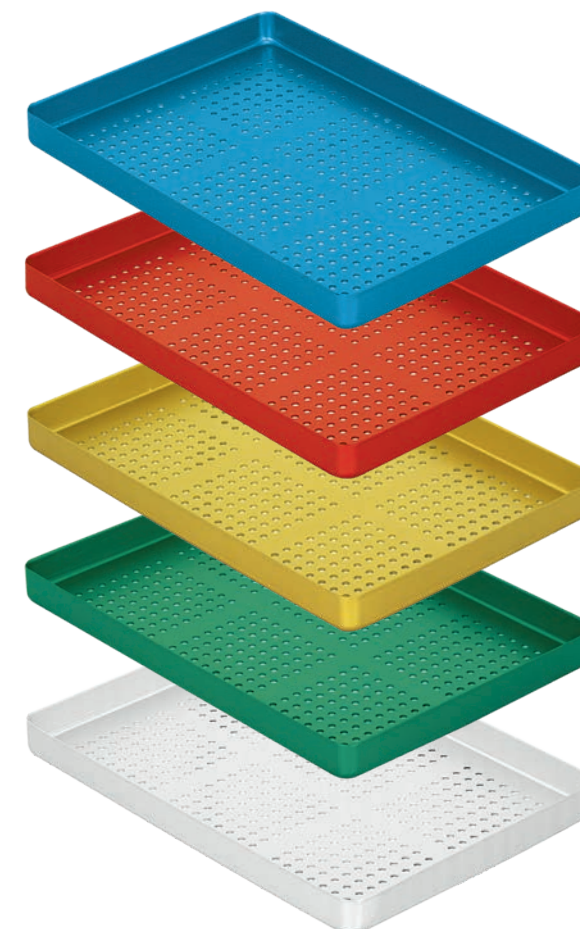

288x187x29 mm
coperchio

Argento
AL2721-UA



Griglie portastrumenti in alluminio



per 10 strumenti
AL2730-3

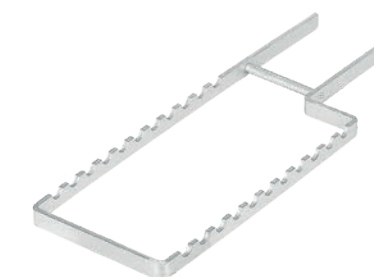

per 11 strumenti
AL2730-4

Vassoi portastrumenti in alluminio anodizzato colorato

MEDIUM
142x183x17 mm

Celeste
AL2722-LC

Rosso
AL2722-LR

Oro
AL2722-LO

Verde
AL2722-LV

Argento
AL2722-LA

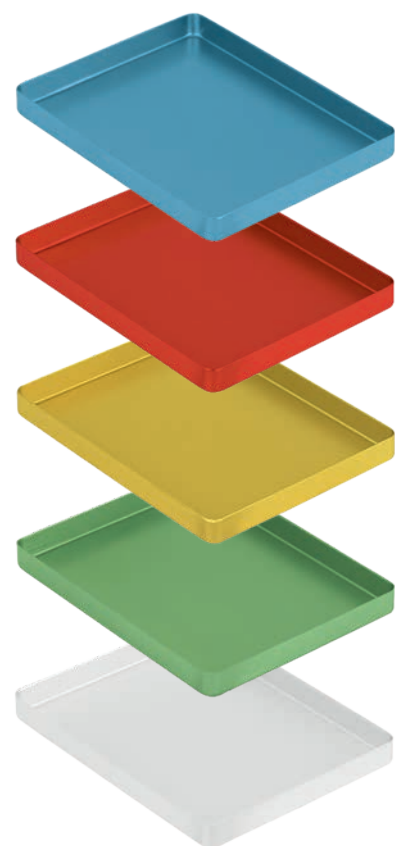

144x187x29 mm
coperchio

Argento
AL2722-UA



Vassoi portastrumenti in alluminio anodizzato colorato

MINI
100x180x11 mm

Celeste
AL2723-LC

Rosso
AL2723-LR

Oro
AL2723-LO

Verde
AL2723-LV

Argento
AL2723-LA



103x182x10 mm
coperchio

Argento
AL2723-UA



AL2722-LC
vassoi in alluminio
per protocollo operativo

Griglie portastrumenti in alluminio

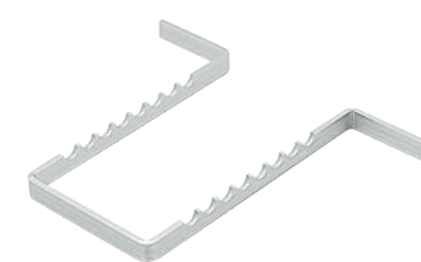

per 8 strumenti
AL2731-1

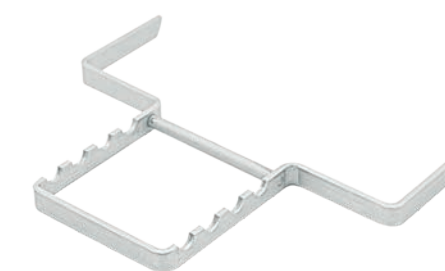

per 4 strumenti
AL2731-2

Vassoi in acciaio inox

MAXI
200x150 mm



2737-1



2737-2

bacinella inox
reniforme



2737-3
170x100x35 mm



2737-4
250x140x40 mm

Vassoio porta pinze

vassoio in acciaio inox porta pinze
STANDARD



S5800

Lubrificanti per la protezione degli strumenti in autoclave

Massima protezione degli strumenti in autoclave. Penetra negli snodi e lubrifica. Protegge e lubrifica gli strumenti chirurgici e dentali prima e dopo la sterilizzazione. Modalità d'uso: oliare prima e dopo la sterilizzazione le punte, gli snodi e le chiusure degli strumenti



Steril Oil
40 ml
8002

Lubrificante speciale per strumenti dentali e chirurgici. Per lubrificare gli snodi di forbici, pinze per estrazione, ossivore, emostatiche, porta aghi ecc. prima e dopo la sterilizzazione. Non viene assorbito durante la sterilizzazione. Protegge dalla corrosione e da altri depositi e cura il buon funzionamento degli strumenti



Silicone
40 ml
8010

Bacinelle in alluminio anodizzato per vassoi portastrumenti



AL2724-1
49x26x10 mm



AL2724-2
49x26x10 mm



AL2724-3
59x49x10 mm



AL2724-4
59x49x10 mm

Porta vassoi in alluminio

STANDARD
300x190x270 mm

MEDIUM
160x190x270 mm



6 ripiani
AL2739-1



6 ripiani
AL2739-2

Pinze per sterilizzazione



20 cm
0565-1



30 cm
0565-2

Contenitori per endodonzia

contenitori per endodonzia in alluminio anodizzato completi di coperchio

MAXI
204x105x54 mm



AL2740-1



AL2740-2



AL2740-3

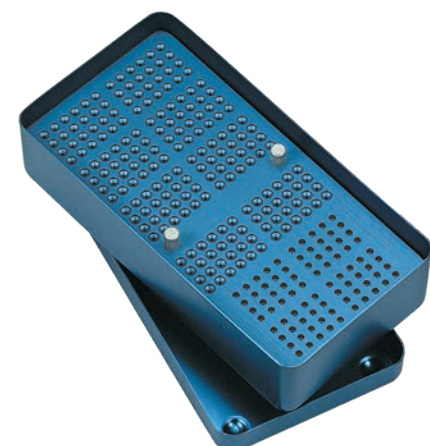

AL2740-4

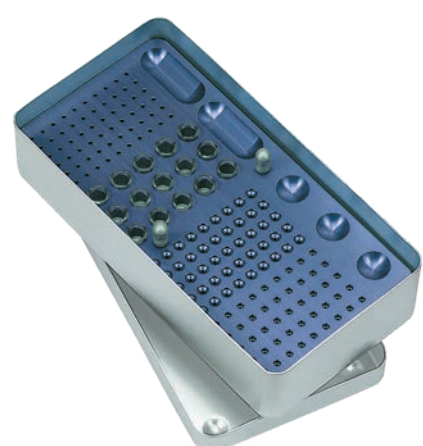

AL2740-5

MEDIUM
125x105x54 mm



AL2741-1



AL2741-2

bicchierini di ricambio
per endo-box



AL2740-R

Contenitori per endodonzia

contenitori per endodonzia in alluminio anodizzato completi di coperchio

MINI
100x44x54 mm



AL2742-1

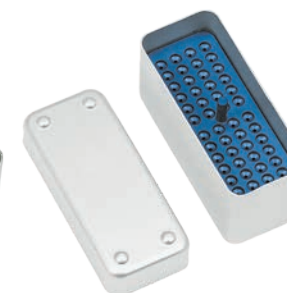

AL2742-2

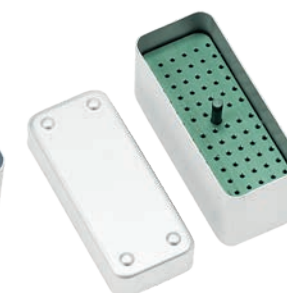

AL2742-3



AL2742-4



AL2742-5



AL2742-6



AL2742-7

contenitori per endodonzia rotondi in alluminio anodizzato
completi di coperchio



AL2744
Ø 48 mm - h. 62 mm



AL2743
Ø 94 mm - h. 70 mm

bicchierini di ricambio
per endo-box



AL2740-R

Accessori per endodonzia

vassoio per endodonzia in alluminio
completo di coperchio
257x116x16 mm

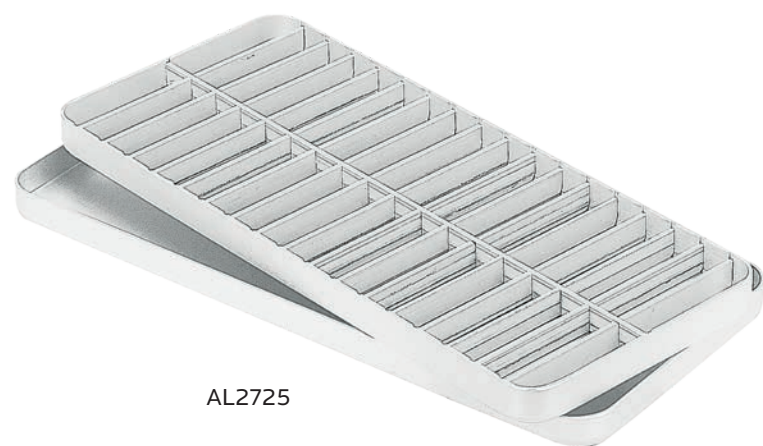

AL2725

pulitori per strumenti canalari in alluminio anodizzato
Ø 40 mm - h. 30 mm



AL2746-1



AL2746-2

misuratori per strumenti canalari, in alluminio anodizzato
100x40x40 mm



AL2747-1A

Ø 34 mm - h. 48 mm



AL2745-1A



AL2745-2C

Porta frese



con 7 porta frese
con coperchio
AL2763-1



con 2 porta frese
AL2763-2

autoclavabili
silicone alimentare atossico
il coperchio in plastica non è autoclavabile

- possibilità di inserire sia frese da turbina sia frese da micromotore, permettendo di preparare un unico porta frese contenente tutte le frese necessarie
- possibilità di predisporre set operativi differenziati per colore permettendo così di ottimizzare al massimo i tempi di intervento, lo stoccaggio e la scelta
- i fori a croce, presenti sui migliori porta frese in silicone, ne bloccano la fuoriuscita, prevenendone cadute accidentali o eventuali rotture



Arancio
S2760-A



Blu
S2760-C

alluminio
sterilizzabile in autoclave a vapore saturo



con bordo, 24 fori FG
AL2760-1
(frese piccole)



con bordo, 24 fori CA
AL2760-2
(frese grandi)



con bordo, 24 fori FG/CA
AL2760-3
(frese piccole e grandi)



AL2760-U
coperchio



con bordo, 36 fori FG
AL2761-1
(frese piccole)



con bordo, 36 fori CA
AL2761-2
(frese grandi)



con bordo, 36 fori FG/CA
AL2761-3
(frese piccole e grandi)



AL2761-U
coperchio per AL2761-1, 2, 3
e per porta frese in silicone



48 fori FG
AL2762-1
(frese piccole)



48 fori CA
AL2762-2
(frese grandi)



48 fori FG/CA
AL2762-3
(frese piccole e grandi)

Accessori

portarifiuti in alluminio anodizzato
sterilizzabili
disponibili in 5 colori
Ø 7 x h. 7,5 cm



AL2764-A



AL2764-C



AL2764-O



AL2764-R



AL2764-V

distributori di cotone in alluminio anodizzato con molla interna
sterilizzabili
disponibili in 5 colori
Ø 7 x h. 7,5 cm



AL2765-A



AL2765-C



AL2765-O



AL2765-R



AL2765-V

portarifiuti monouso
1000 pz / confezione



AL2767-1

supporto in alluminio
per portarifiuti



AL2767-2

Accessori

contenitore in plastica per aghi usati



AL2766

distributore di palline di cotone in acciaio inox
40x40x50 mm



2751-1

lampada ad alcool in acciaio inox
con stoppino



3101



stoppino di ricambio
15 cm



3101-1



PORTAIMPRONTA

MADE IN ITALY

AD OGNUNO LA SUA FORMA

Rilevare l'impronta delle arcate del paziente in maniera corretta è di primaria importanza per poter ottenere un risultato ottimale fin da subito. Scegliere una dimensione sbagliata o una forma non adatta, porta di solito ad un'impronta inadeguata: interventi di terapia conservativa e protesi possono in tal modo dare origine a problemi di scarsa o mal occlusione e richiedere costi e tempi più elevati.

I portaimpronta Asa Dental sono disponibili in diverse forme e materiali, dispongono di un pratico sistema colorimetrico che rende immediata l'individuazione della misura, e garantiscono tutta la necessaria precisione indispensabile per ottenere un risultato perfetto.

- J4 Forate, in acciaio
- J20 Non forate, in acciaio
- J36 Forate, in alluminio
- J39 Per bambini, in alluminio
- J40 Occlusali parziali
- J41 Per implantologia, in alluminio
- J42 In policarbonato

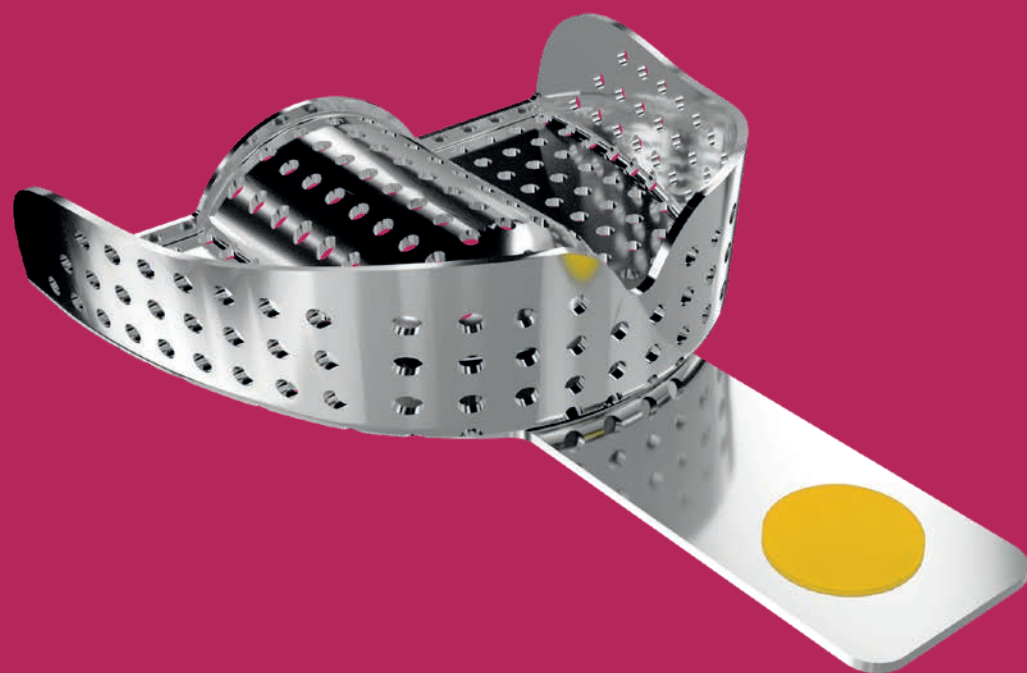

Elementi



Tabella di selezione

MATERIALE PER IMPRONTA	TECNICA					
	Monofasica a 2 materiali	Monofasica a 1 materiale	Bifasica	Impronta bordata	Impronta parziale	Sandwich
Silicone	2802 2803 2807	2880	2800 2801 2804 2804S 2808 2809 2811 2813 2814 2806		2819	2819 2803S
Alginato	2804S 2813	2851 2852 2804 2801 2800 2814	2806 2851	2851		
Polietere/Polisolfuro	2802 2803 2807	2802 2803 2803S 2807 2810				2807S 2810

Legenda

2880: ideale
2807: compatibile

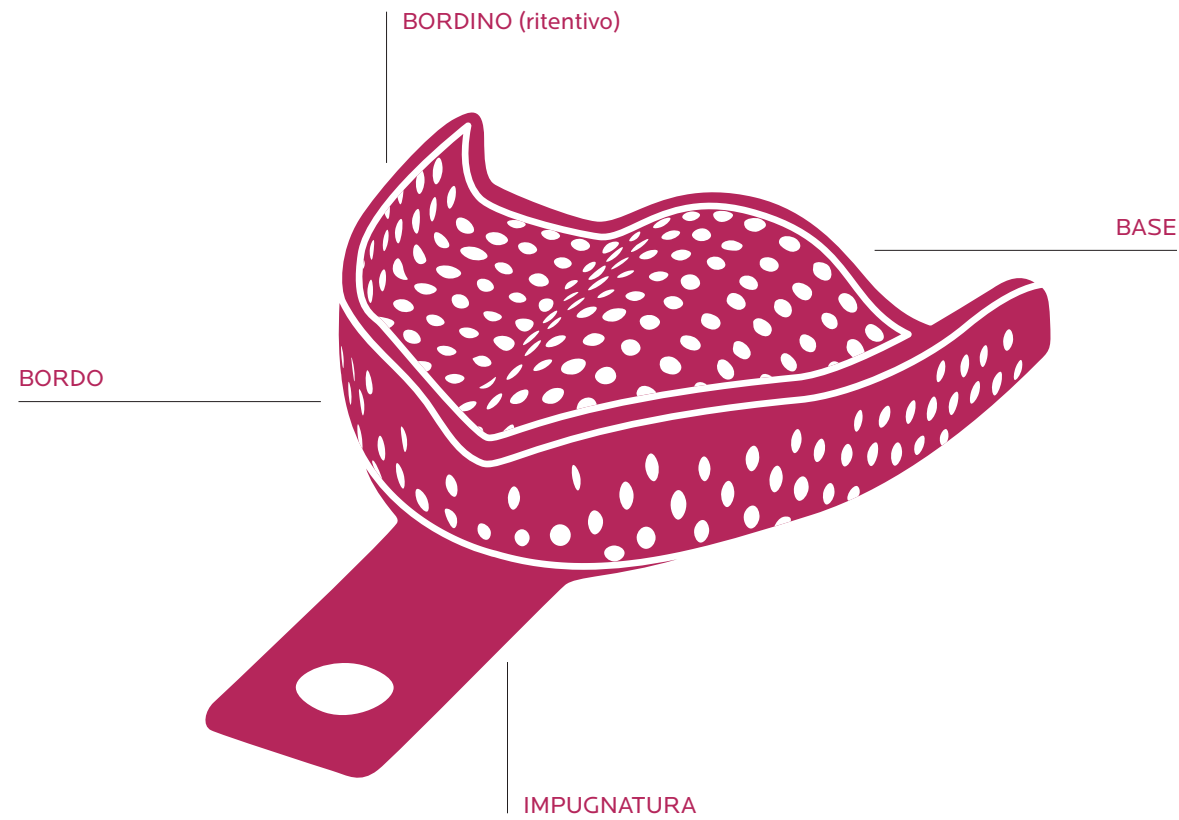
Indice dei colori

ASA Codicolor

- U1/L1
XXS
- U2/L2
XS
- U3/L3
S
- U4/L4
M
- U5/L5
L
- U6/L6
XL



Classificazione

STRUTTURA	DENTIZIONE	FORMA	MATERIALE
forato non forato	edentuli dentuli	completo parziale	acciaio inox alluminio policarbonato

Portaimpronta forati in acciaio inox - PERMA-LOCK

con bordino ritentivo

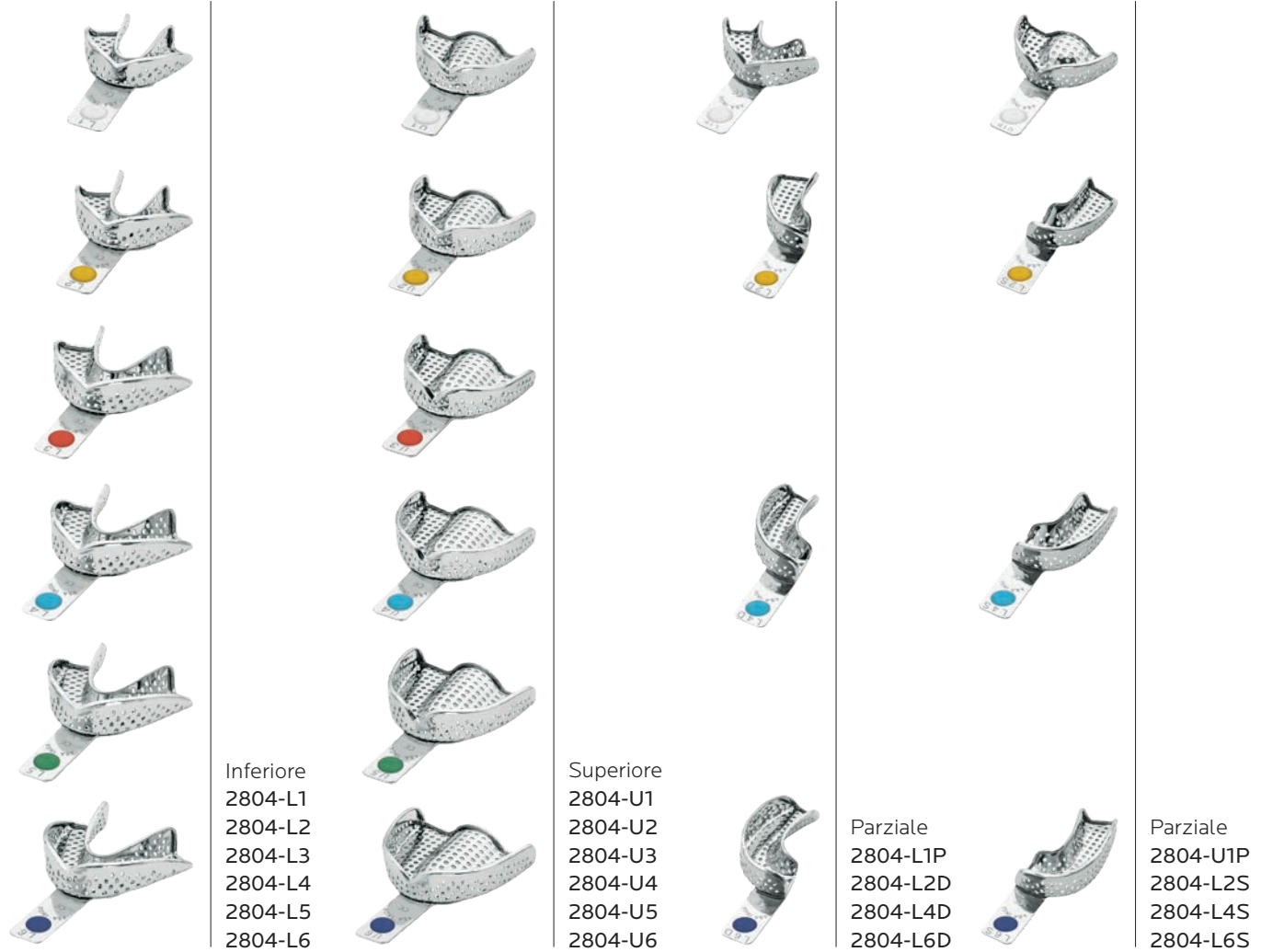

Inferiore
2804-L1
2804-L2
2804-L3
2804-L4
2804-L5
2804-L6

Superiore
2804-U1
2804-U2
2804-U3
2804-U4
2804-U5
2804-U6

Parziale
2804-L1P
2804-L2D
2804-L4D
2804-L6D

Parziale
2804-U1P
2804-L2S
2804-L4S
2804-L6S



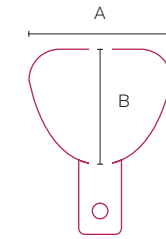
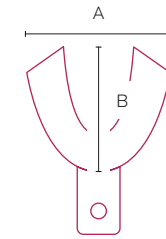

Portaimpronta forati in acciaio inox - PERMA-LOCK

con bordino ritentivo



2804 Superiore		A (mm)	B (mm)
U1	XXS	61	47
U2	XS	64	51
U3	S	66	53
U4	M	69	57
U5	L	71	60
U6	XL	73	62

ASA Codicolor

-  **U1/L1**
XXS
-  **U2/L2**
XS
-  **U3/L3**
S
-  **U4/L4**
M
-  **U5/L5**
L
-  **U6/L6**
XL



Portaimpronta forati in acciaio inox - PERMA-LOCK ANATOMIC

con bordino ritentivo

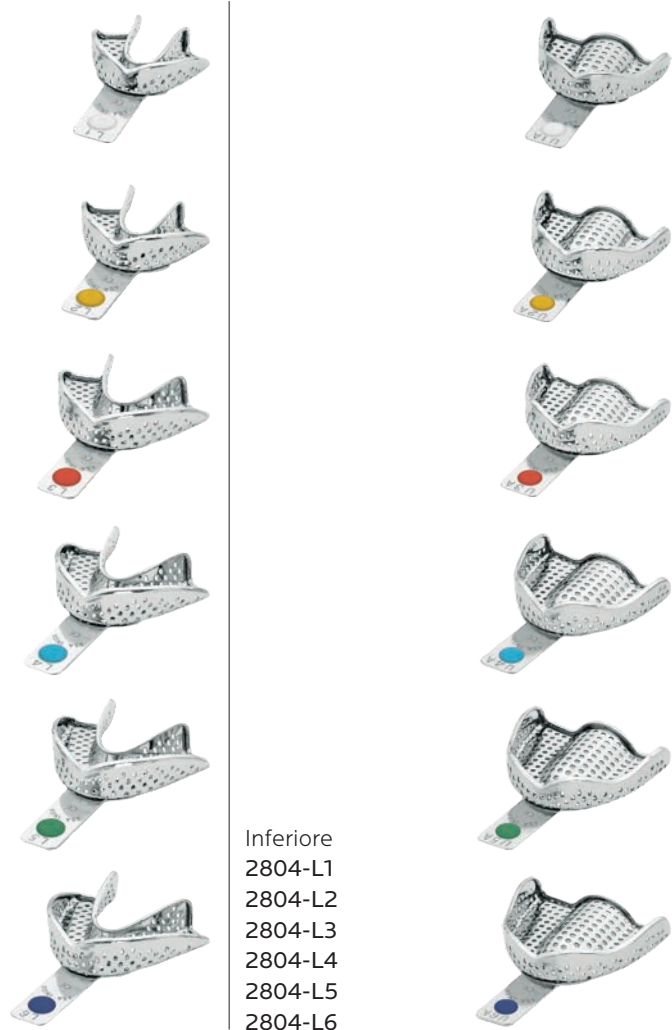

Inferiore
2804-L1
2804-L2
2804-L3
2804-L4
2804-L5
2804-L6



Superiore
2804-U1A
2804-U2A
2804-U3A
2804-U4A
2804-U5A
2804-U6A

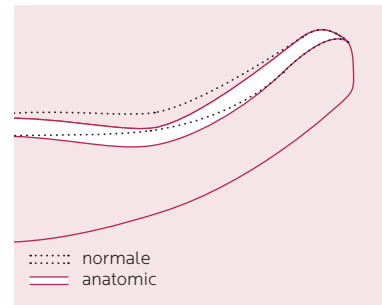

Portaimpronta forati in acciaio inox - PERMA-LOCK ANATOMIC

con bordino ritentivo

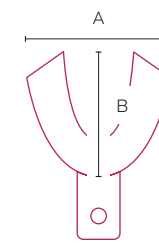

2804 Inferiore		A (mm)	B (mm)
L1	XXS	55	47
L2	XS	60	49
L3	S	72	54
L4	M	74	57
L5	L	76	59
L6	XL	78	61

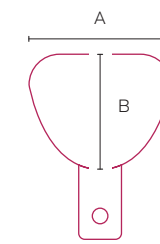

2804A Superiore		A (mm)	B (mm)
U1A	XXS	61	47
U2A	XS	64	51
U3A	S	66	53
U4A	M	69	57
U5A	L	71	60
U6A	XL	73	62



ASA Codicolor

- U1/L1
XXS
- U2/L2
XS
- U3/L3
S
- U4/L4
M
- U5/L5
L
- U6/L6
XL

Portaimpronta forati in acciaio inox - PERMA-LOCK HIGH GRIP

con bordino ritentivo maggiorato e superficie interna microritentiva



Inferiore
2804S-L1
2804S-L2
2804S-L3
2804S-L4
2804S-L5
2804S-L6



Superiore
2804S-U1
2804S-U2
2804S-U3
2804S-U4
2804S-U5
2804S-U6



Portaimpronta forati in acciaio inox - PERMA-LOCK HIGH GRIP

con bordino ritentivo maggiorato e superficie interna microritentiva

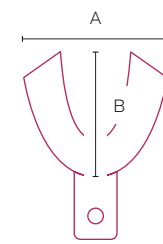

2804S Inferiore		A (mm)	B (mm)
L1	XXS	55	47
L2	XS	60	49
L3	S	72	54
L4	M	74	57
L5	L	76	59
L6	XL	78	61

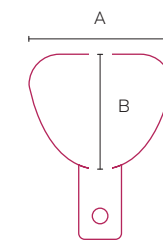

2804S Superiore		A (mm)	B (mm)
U1	XXS	61	47
U2	XS	64	51
U3	S	66	53
U4	M	69	57
U5	L	71	60
U6	XL	73	62



S2804S-12
set da 12



S2804S-8
set da 8



S2804S-6
set da 6

Portaimpronta forati in acciaio inox - depressi anteriormente

con bordino ritentivo



Inferiore
2809-L22
2809-L21
2809-L20



Superiore
2809-U7
2809-U4
2809-U1

L22
L21
L20



S2809-6
set da 6

U7
U4
U1

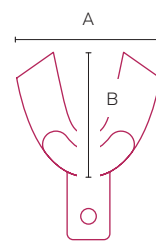

2809 Inferiore		A (mm)	B (mm)
L22	S	76	54
L21	M	79	57
L20	L	81	60

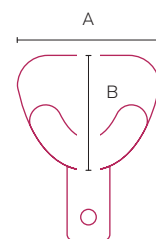

2809 Superiore		A (mm)	B (mm)
U7	S	70	57
U4	M	71	64
U1	L	81	67

Portaimpronta forati in acciaio inox - edentuli

con bordino ritentivo



Inferiore
2806-L69
2806-L68
2806-L67
2806-L66



Superiore
2806-U64
2806-U63
2806-U62
2806-U61

L69
L68
L67
L66

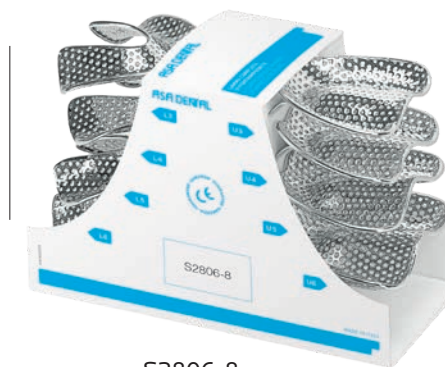

S2806-8
set da 8

U64
U63
U62
U61

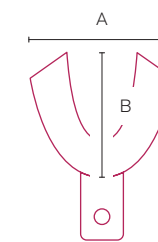

2806 Inferiore		A (mm)	B (mm)
L69	S	70	57
L68	M	73	60
L67	NL	70	64
L66	L	86	64

NL: Narrow Large (large stretta)

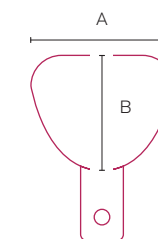

2806 Superiore		A (mm)	B (mm)
U64	S	73	60
U63	NM	70	64
U62	M	76	67
U61	L	79	70

NM: Narrow Medium (medium stretta)

Portaimpronta forati in acciaio inox

senza bordino ritentivo

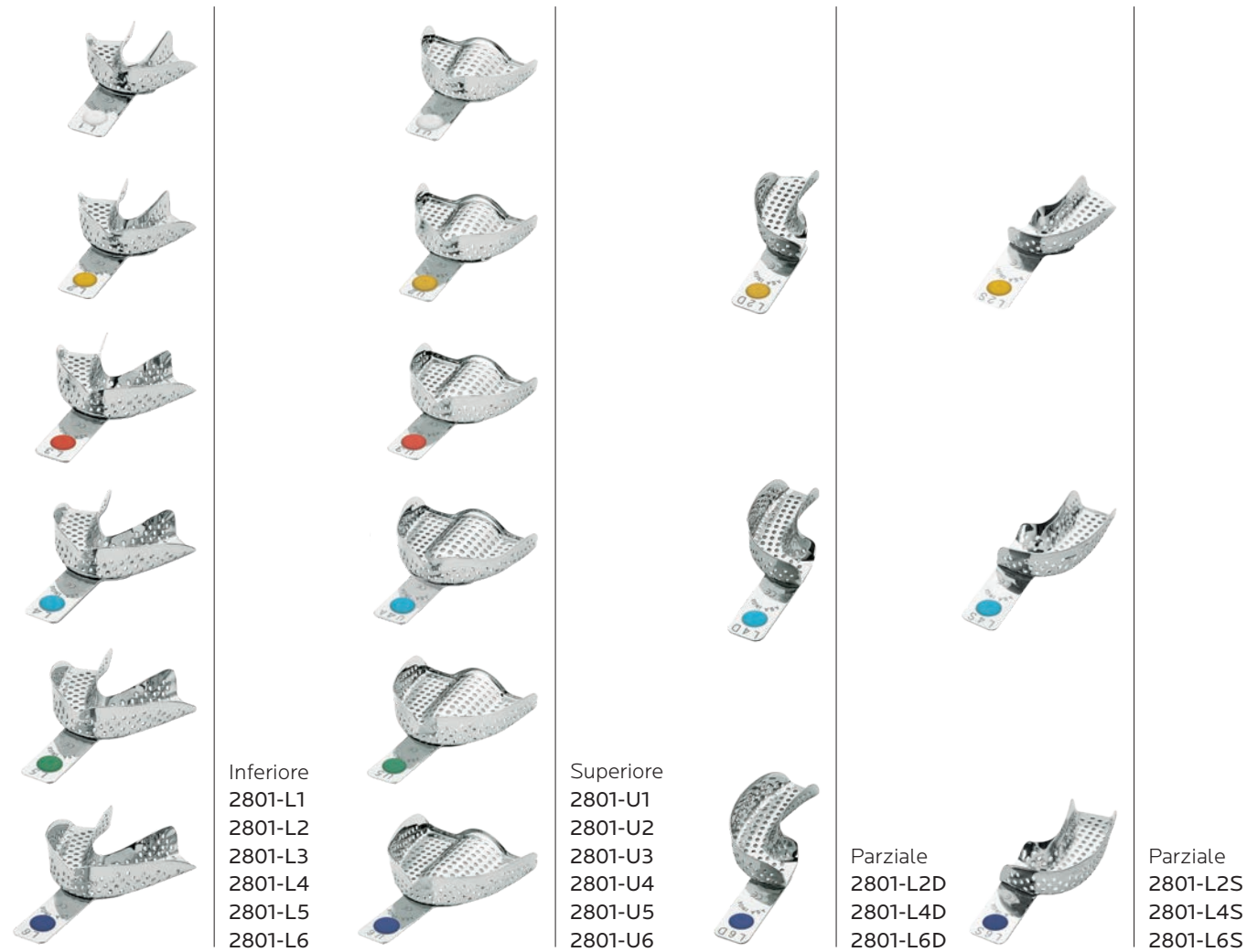
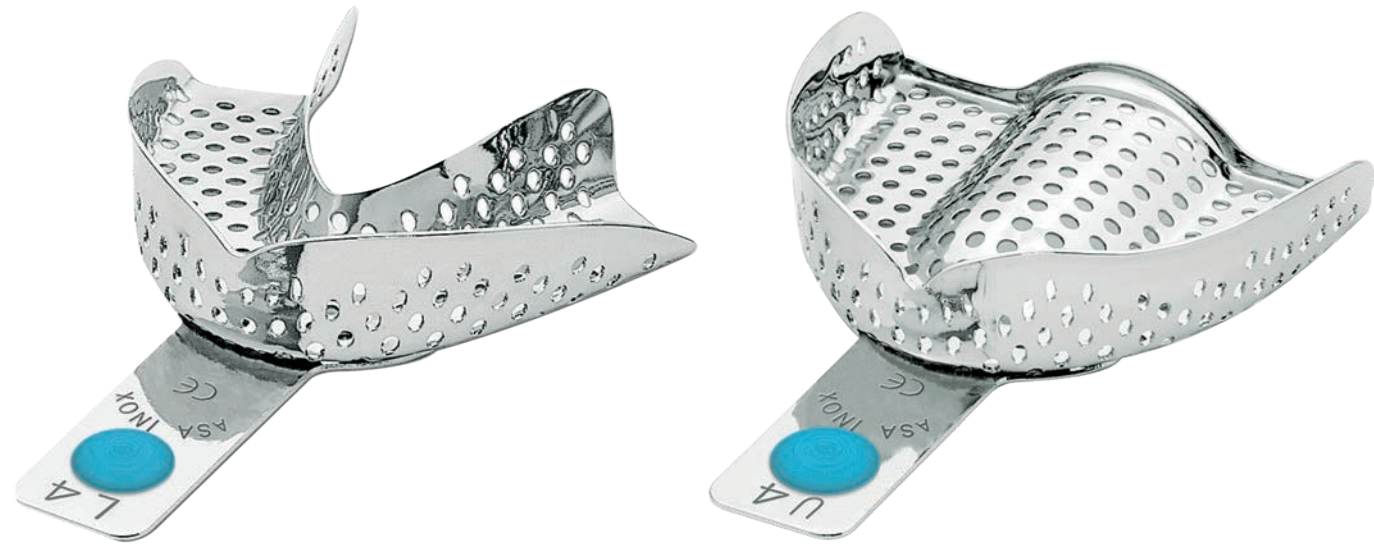

Inferiore
2801-L1
2801-L2
2801-L3
2801-L4
2801-L5
2801-L6

Superiore
2801-U1
2801-U2
2801-U3
2801-U4
2801-U5
2801-U6

Parziale
2801-L2D
2801-L4D
2801-L6D

Parziale
2801-L2S
2801-L4S
2801-L6S

Portaimpronta forati in acciaio inox

senza bordino ritentivo

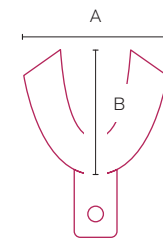

2801 Inferiore		A (mm)	B (mm)
L1	XXS	55	47
L2	XS	60	49
L3	S	72	54
L4	M	74	57
L5	L	76	59
L6	XL	78	61

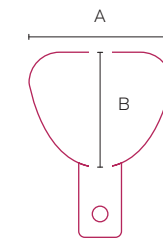

2801 Superiore		A (mm)	B (mm)
U1	XXS	61	47
U2	XS	64	51
U3	S	66	53
U4	M	69	57
U5	L	71	60
U6	XL	73	62

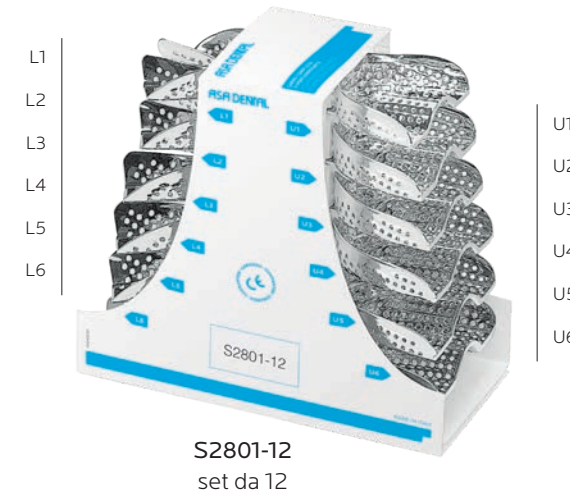

ASA Codicolor

- U1/L1
XXS
- U2/L2
XS
- U3/L3
S
- U4/L4
M
- U5/L5
L
- U6/L6
XL

Portaimpronta forati in acciaio inox - ANATOMIC

senza bordino ritentivo

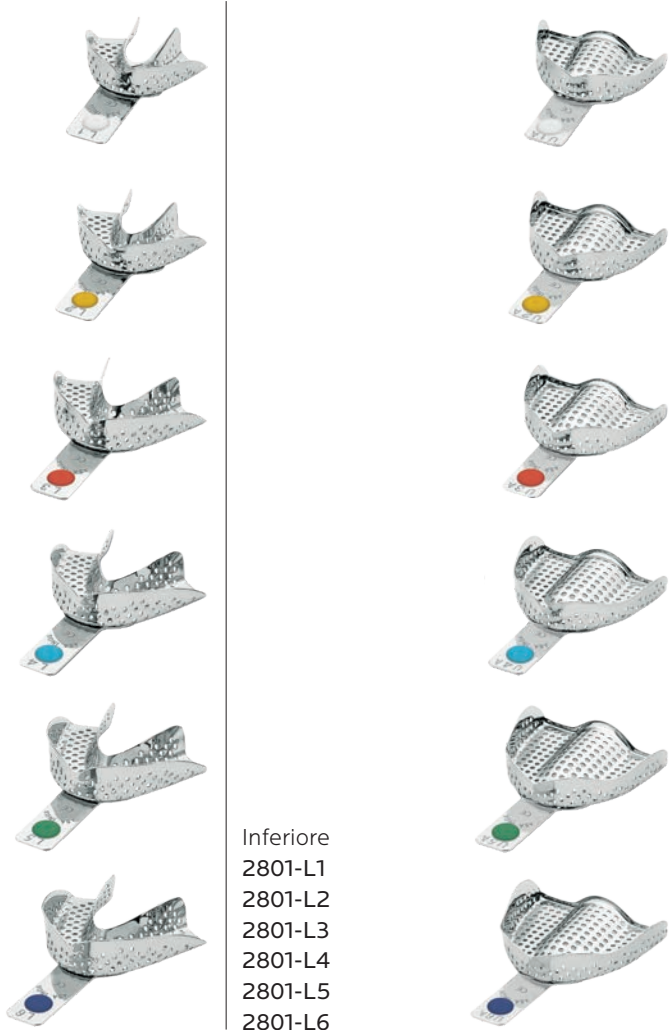
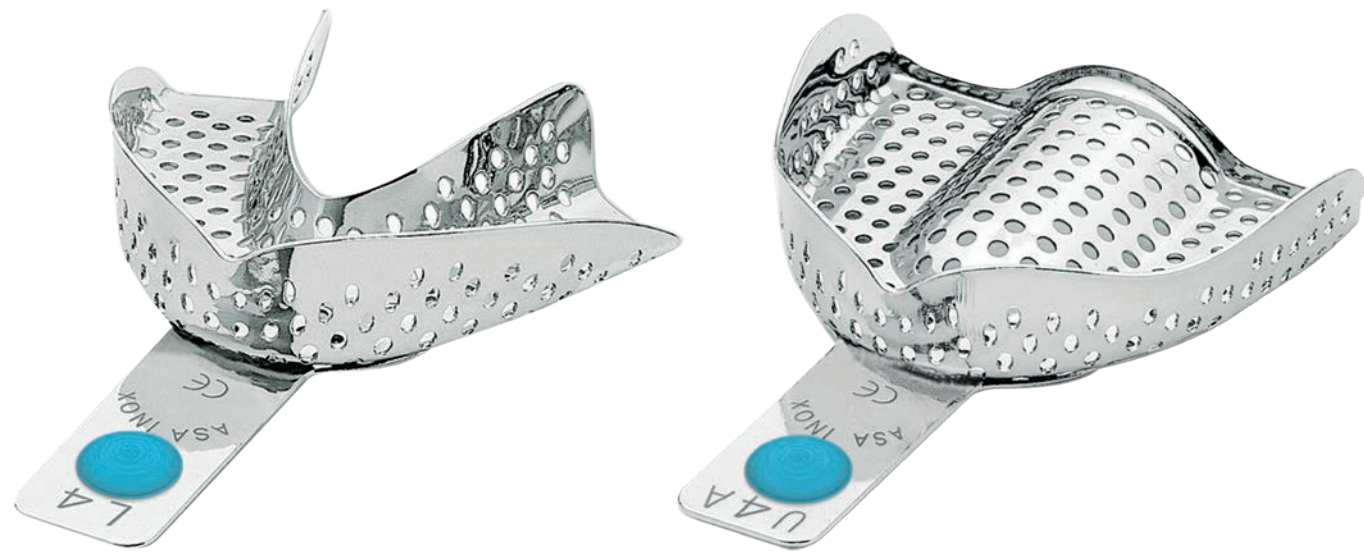

Inferiore
2801-L1
2801-L2
2801-L3
2801-L4
2801-L5
2801-L6



Superiore
2801-U1A
2801-U2A
2801-U3A
2801-U4A
2801-U5A
2801-U6A

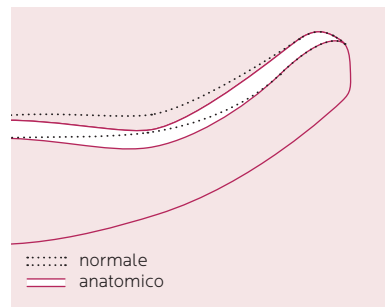

Portaimpronta forati in acciaio inox - ANATOMIC

senza bordino ritentivo

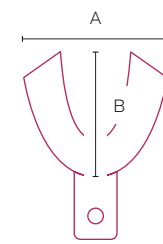

2801 Inferiore		A (mm)	B (mm)
L1	XXS	55	47
L2	XS	60	49
L3	S	72	54
L4	M	74	57
L5	L	76	59
L6	XL	78	61

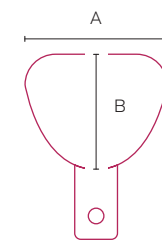

2801A Superiore		A (mm)	B (mm)
U1	XXS	61	47
U2	XS	64	51
U3	S	66	53
U4	M	69	57
U5	L	71	60
U6	XL	73	62



ASA Codicolor

- U1/L1
XXS
- U2/L2
XS
- U3/L3
S
- U4/L4
M
- U5/L5
L
- U6/L6
XL

Portaimpronta forati in acciaio inox - Ehrlicke

senza bordino ritentivo

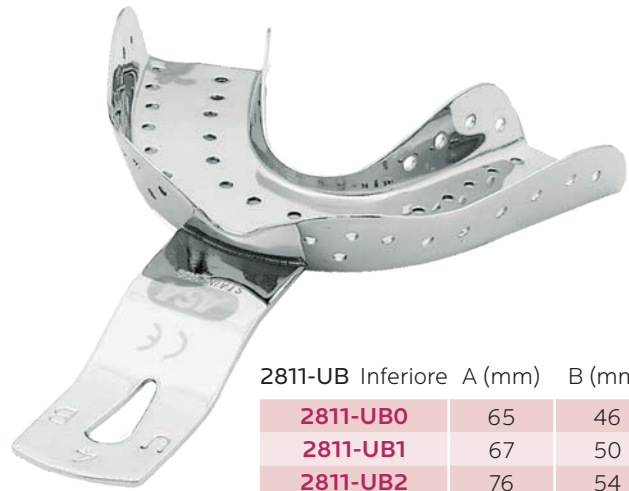
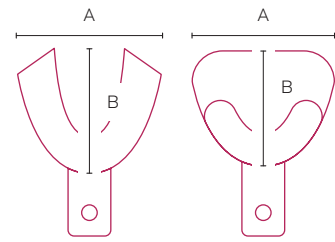

2811-UB Inferiore A (mm) B (mm)

2811-UB0	65	46
2811-UB1	67	50
2811-UB2	76	54
2811-UB3	79	56
2811-UB4	79	61

per arcate inferiori, per bambini



2811-OB Superiore A (mm) B (mm)

2811-OB0	59	52
2811-OB1	66	52
2811-OB2	71	62
2811-OB3	71	64
2811-OB4	80	70

per arcate superiori, per bambini



2811-BS Superiore A (mm) B (mm)

2811-BS2	70	54
-----------------	----	----

per arcate superiori strette

Portaimpronta forati in acciaio inox - Ehrlicke

senza bordino ritentivo

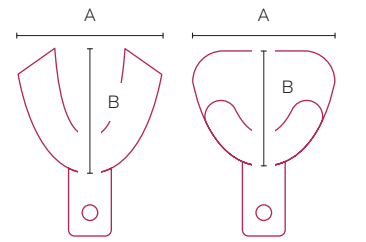

2811-UU Inferiore A (mm) B (mm)

2811-UU1	70	48
2811-UU2	70	53
2811-UU3	72	57

per arcate inferiore edentule



2811-OU Superiore A (mm) B (mm)

2811-OU1	64	46
2811-OU2	68	53
2811-OU3	79	61

per arcate superiori edentule

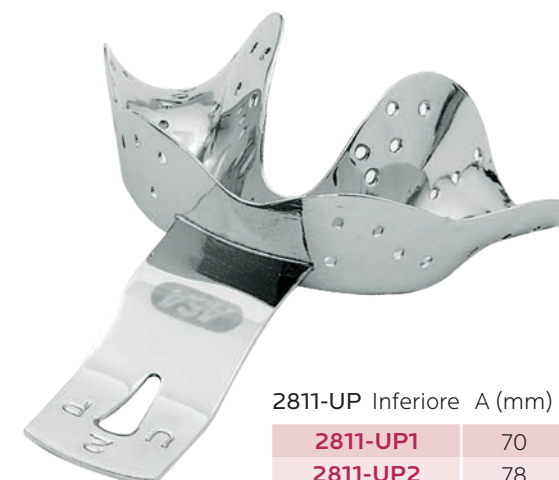

2811-UP Inferiore A (mm) B (mm)

2811-UP1	70	55
2811-UP2	78	59

per arcate inferiori parzialmente dentate



2811-OP Inferiore A (mm) B (mm)

2811-OP1	62	50
2811-OP2	70	56

per arcate superiori parzialmente dentate



S2811-1 set da 10



S2811-2 set da 6



S2811-3 set da 10

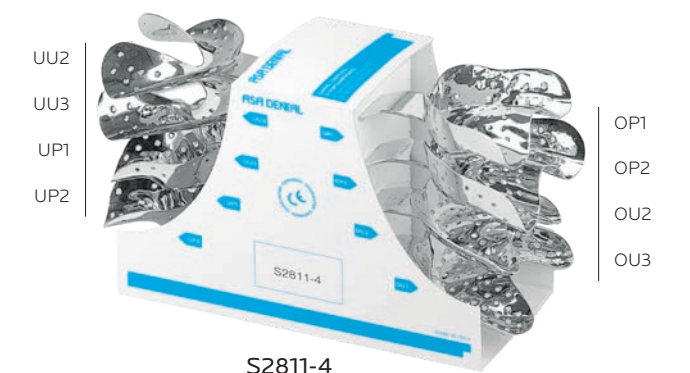

S2811-4 set da 8

Portaimpronta forati in acciaio inox - edentuli

senza bordino ritentivo



Portaimpronta forati in acciaio inox - edentuli

senza bordino ritentivo

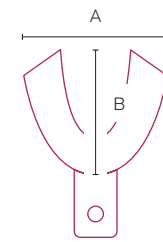

2813 Inferiore		A (mm)	B (mm)
L1	XXS	60	54
L2	XS	67	55
L3	S	70	56
L4	M	74	58
L5	L	76	60
L6	XL	80	62

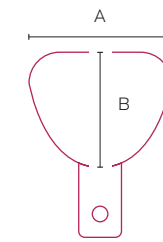

2813 Superiore		A (mm)	B (mm)
U1	XXS	60	50
U2	XS	64	54
U3	S	68	58
U4	M	70	60
U5	L	78	64



Inferiore
2813-L1
2813-L2
2813-L3
2813-L4
2813-L5
2813-L6



Superiore
2813-U1
2813-U2
2813-U3
2813-U4
2813-U5

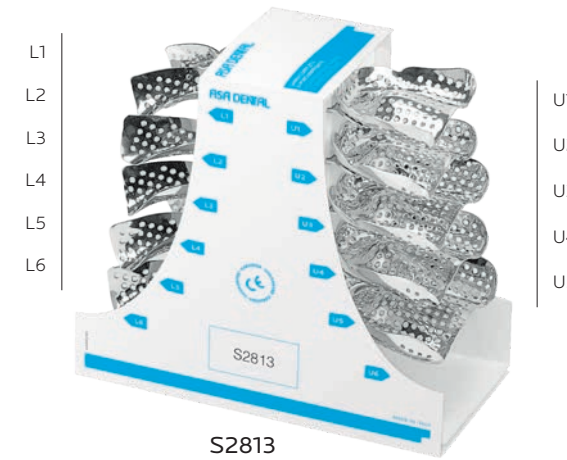

S2813
set da 11 pezzi
più compasso per
impronte definitive



MB026-1
compasso in acciaio inox

Portaimpronta non forati in acciaio inox - NEW SUPER

con bordino ritentivo



Portaimpronta non forati in acciaio inox - NEW SUPER

con bordino ritentivo

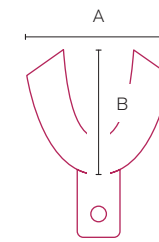



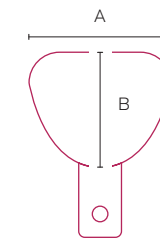

2803 Inferiore		A (mm)	B (mm)
L5	XS	69	50
L4	S	72	57
L3	M	76	57
L2	L	78	59
L1	XL	80	63



2803 Superiore		A (mm)	B (mm)
U5	XS	65	51
U4	S	67	53
U3	M	71	55
U2	L	74	60
U1	XL	81	63

ASA Codicolor

-  **U5/L5**
XS
-  **U4/L4**
S
-  **U3/L3**
M
-  **U2/L2**
L
-  **U1/L1**
XL



Inferiore
2803-L5
2803-L4
2803-L3
2803-L2
2803-L1



Superiore
2803-U5
2803-U4
2803-U3
2803-U2
2803-U1



Portaimpronta non forati in acciaio inox - PERMA-LOCK

con bordino ritentivo

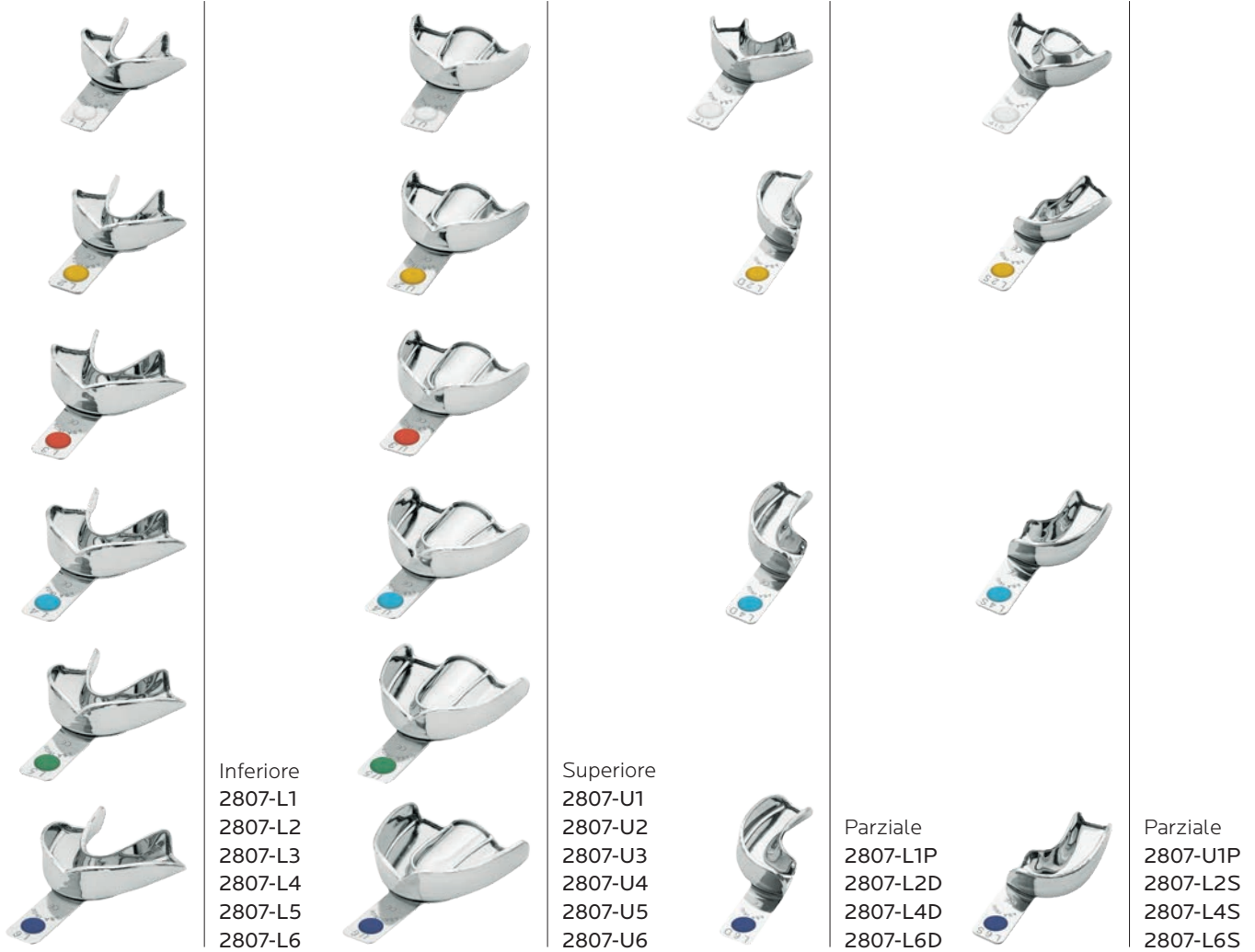

Inferiore
2807-L1
2807-L2
2807-L3
2807-L4
2807-L5
2807-L6

Superiore
2807-U1
2807-U2
2807-U3
2807-U4
2807-U5
2807-U6

Parziale
2807-L1P
2807-L2D
2807-L4D
2807-L6D

Parziale
2807-U1P
2807-L2S
2807-L4S
2807-L6S

Portaimpronta non forati in acciaio inox - PERMA-LOCK

con bordino ritentivo

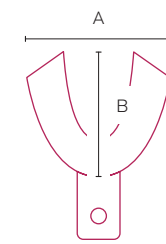

2807 Inferiore		A (mm)	B (mm)
L1	XXS	55	47
L2	XS	60	49
L3	S	72	54
L4	M	74	57
L5	L	76	59
L6	XL	78	61

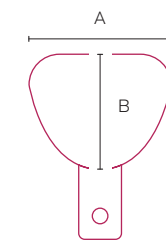

2807 Superiore		A (mm)	B (mm)
U1	XXS	61	47
U2	XS	64	51
U3	S	66	53
U4	M	69	57
U5	L	71	60
U6	XL	73	62



ASA Codicolor

- U1/L1
XXS
- U2/L2
XS
- U3/L3
S
- U4/L4
M
- U5/L5
L
- U6/L6
XL

Portaimpronta non forati in acciaio inox - PERMA-LOCK ANATOMIC

con bordino ritentivo

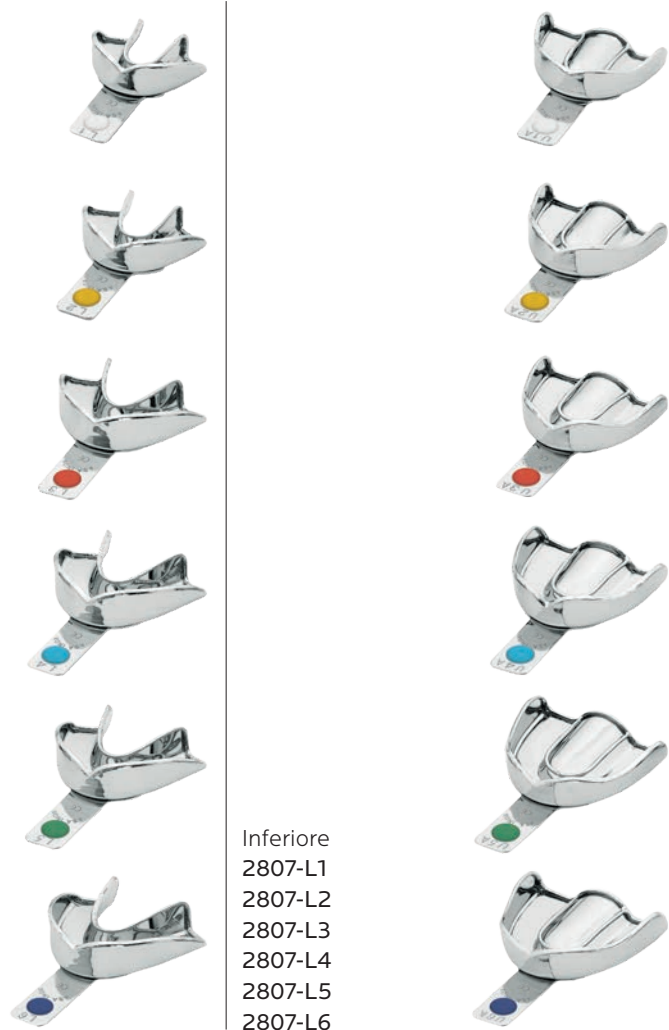

Inferiore
2807-L1
2807-L2
2807-L3
2807-L4
2807-L5
2807-L6



Superiore
2807-U1A
2807-U2A
2807-U3A
2807-U4A
2807-U5A
2807-U6A

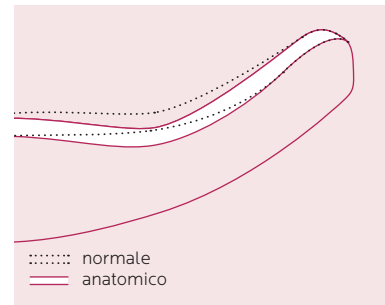

Portaimpronta non forati in acciaio inox - PERMA-LOCK ANATOMIC

con bordino ritentivo

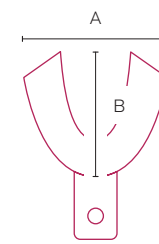

2807 Inferiore		A (mm)	B (mm)
L1	XXS	55	47
L2	XS	60	49
L3	S	72	54
L4	M	74	57
L5	L	76	59
L6	XL	78	61

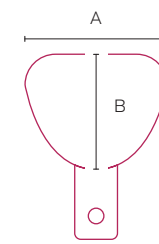

2807A Superiore		A (mm)	B (mm)
U1A	XXS	61	47
U2A	XS	64	51
U3A	S	66	53
U4A	M	69	57
U5A	L	71	60
U6A	XL	73	62



ASA Codicolor

- U1/L1
XXS
- U2/L2
XS
- U3/L3
S
- U4/L4
M
- U5/L5
L
- U6/L6
XL

Portaimpronta non forati in acciaio inox - PERMA-LOCK HIGH GRIP

con bordino ritentivo maggiorato e superficie interna microritentiva



Portaimpronta non forati in acciaio inox - PERMA-LOCK HIGH GRIP

con bordino ritentivo maggiorato e superficie interna microritentiva

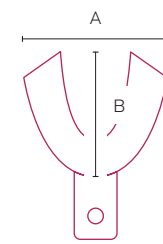

2807S Inferiore		A (mm)	B (mm)
L1	XXS	55	47
L2	XS	60	49
L3	S	72	54
L4	M	75	57
L5	L	76	59
L6	XL	78	61

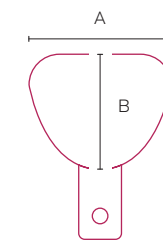

2807S Superiore		A (mm)	B (mm)
U1	XXS	61	47
U2	XS	64	51
U3	S	66	53
U4	M	69	57
U5	L	71	60
U6	XL	73	62

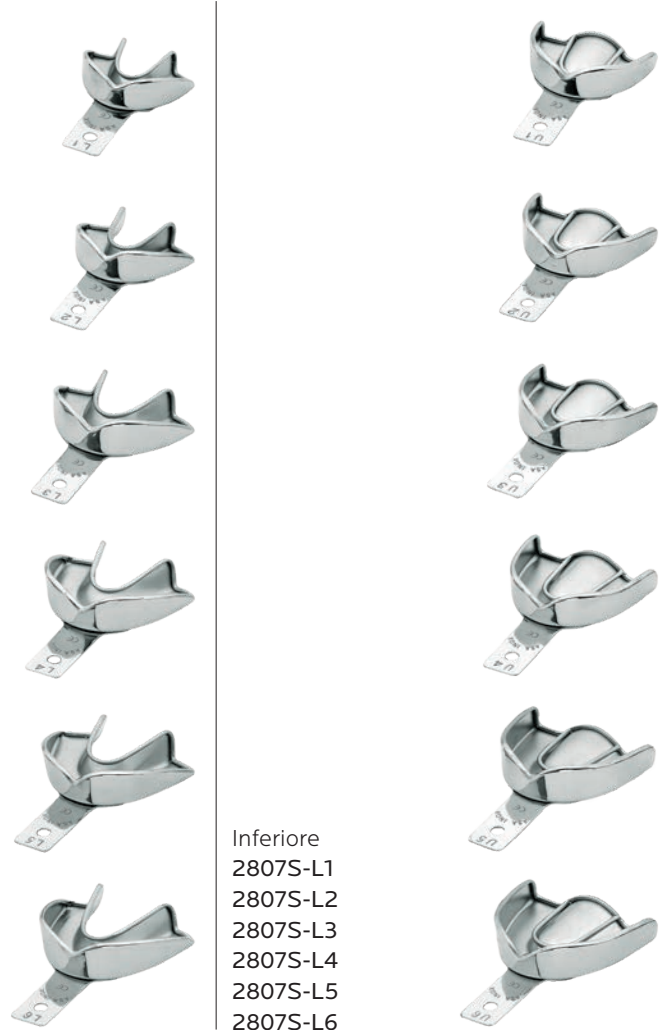

Inferiore
2807S-L1
2807S-L2
2807S-L3
2807S-L4
2807S-L5
2807S-L6



Superiore
2807S-U1
2807S-U2
2807S-U3
2807S-U4
2807S-U5
2807S-U6



S2807S-12
set da 12



S2807S-8
set da 8



S2807S-6
set da 6

Portaimpronta non forati in acciaio inox - depressi anteriormente

con bordino ritentivo



Inferiore
2810-L22
2810-L21
2810-L20



Superiore
2810-U7
2810-U4
2810-U1



S2810-6
set da 6

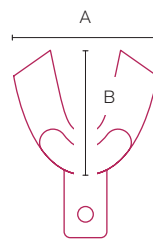

2810 Inferiore		A (mm)	B (mm)
L22	S	76	54
L21	M	79	57
L20	L	81	60

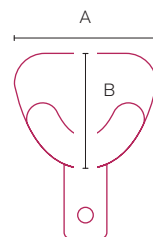

2810 Superiore		A (mm)	B (mm)
U7	S	70	57
U4	M	71	64
U1	L	81	67

Portaimpronta non forati in acciaio inox - edentuli

con bordino ritentivo



Inferiore
2808-L69
2808-L68
2808-L67
2808-L66



Superiore
2808-U64
2808-U63
2808-U62
2808-U61



S2808-8
set da 8

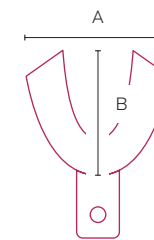

2808 Inferiore		A (mm)	B (mm)
L69	S	70	57
L68	M	73	60
L67	NL	70	64
L66	L	86	64

NL: Narrow Large (large stretta)

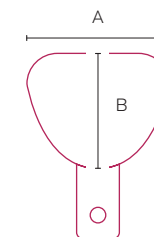

2808 Superiore		A (mm)	B (mm)
U64	S	73	60
U63	NM	70	64
U62	M	76	67
U61	L	79	70

NM: Narrow Medium (medium stretta)

Portaimpronta non forati in acciaio inox - NEW SUPER HIGH GRIP

con bordino ritentivo maggiorato e superficie interna microritentiva



Portaimpronta non forati in acciaio inox - NEW SUPER HIGH GRIP

con bordino ritentivo maggiorato e superficie interna microritentiva

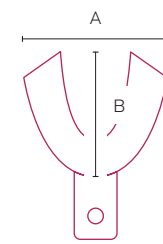

2803S Inferiore		A (mm)	B (mm)
L5	XS	69	50
L4	S	72	57
L3	M	76	57
L2	L	78	59
L1	XL	80	63

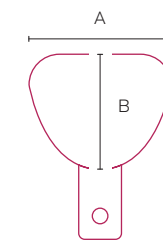

2803S Superiore		A (mm)	B (mm)
U5	XS	65	51
U4	S	67	53
U3	M	71	55
U2	L	74	60
U1	XL	81	63

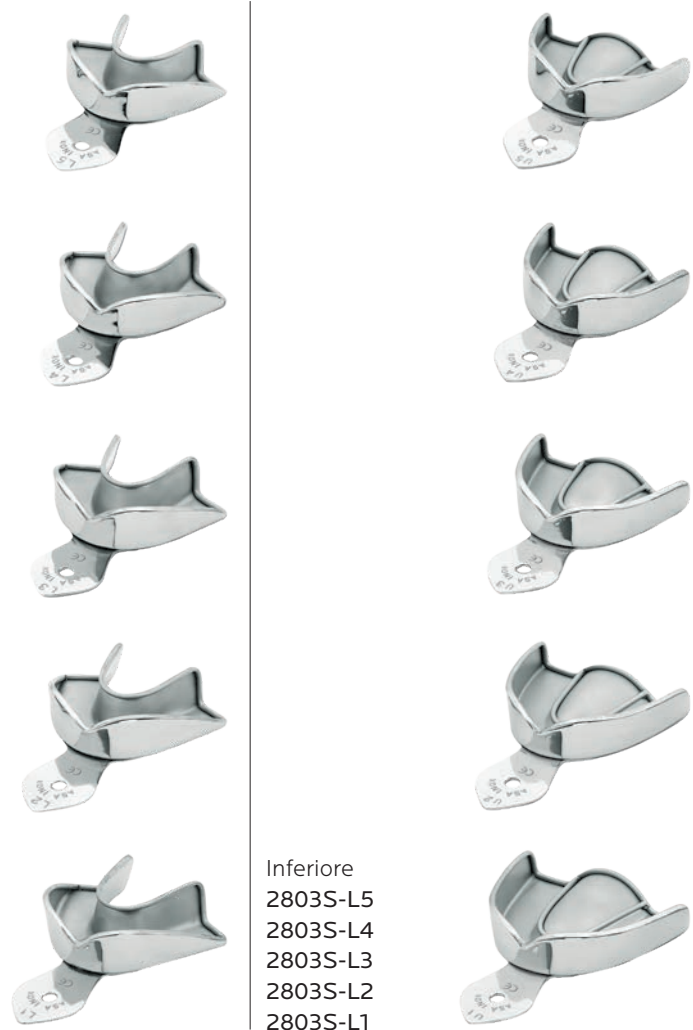

Inferiore
2803S-L5
2803S-L4
2803S-L3
2803S-L2
2803S-L1

Superiore
2803S-U5
2803S-U4
2803S-U3
2803S-U2
2803S-U1



Portaimpronta non forati in acciaio inox

senza bordino ritentivo

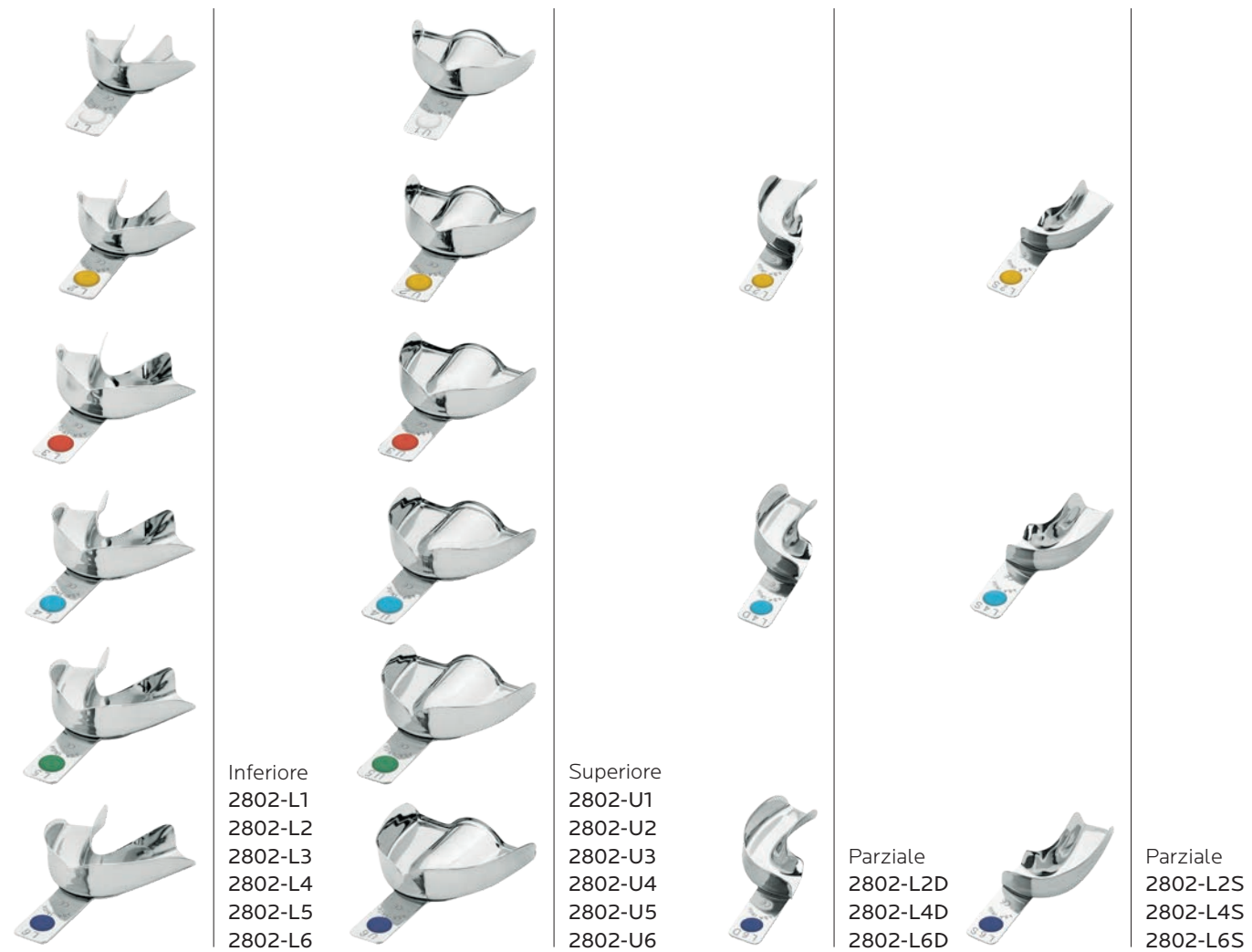

Inferiore
2802-L1
2802-L2
2802-L3
2802-L4
2802-L5
2802-L6

Superiore
2802-U1
2802-U2
2802-U3
2802-U4
2802-U5
2802-U6

Parziale
2802-L2D
2802-L4D
2802-L6D

Parziale
2802-L2S
2802-L4S
2802-L6S

Portaimpronta non forati in acciaio inox

senza bordino ritentivo

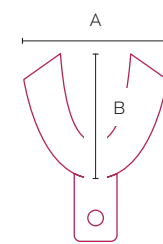

2802 Inferiore		A (mm)	B (mm)
L1	XXS	55	47
L2	XS	60	49
L3	S	72	54
L4	M	74	57
L5	L	76	59
L6	XL	78	61

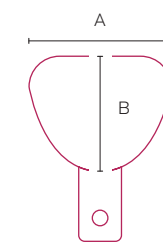

2802 Superiore		A (mm)	B (mm)
U1	XXS	61	47
U2	XS	64	51
U3	S	66	53
U4	M	69	57
U5	L	71	60
U6	XL	73	62

ASA Codicolor

- U1/L1
XXS
- U2/L2
XS
- U3/L3
S
- U4/L4
M
- U5/L5
L
- U6/L6
XL



Portaimpronta non forati in acciaio inox - ANATOMIC

senza bordino ritentivo

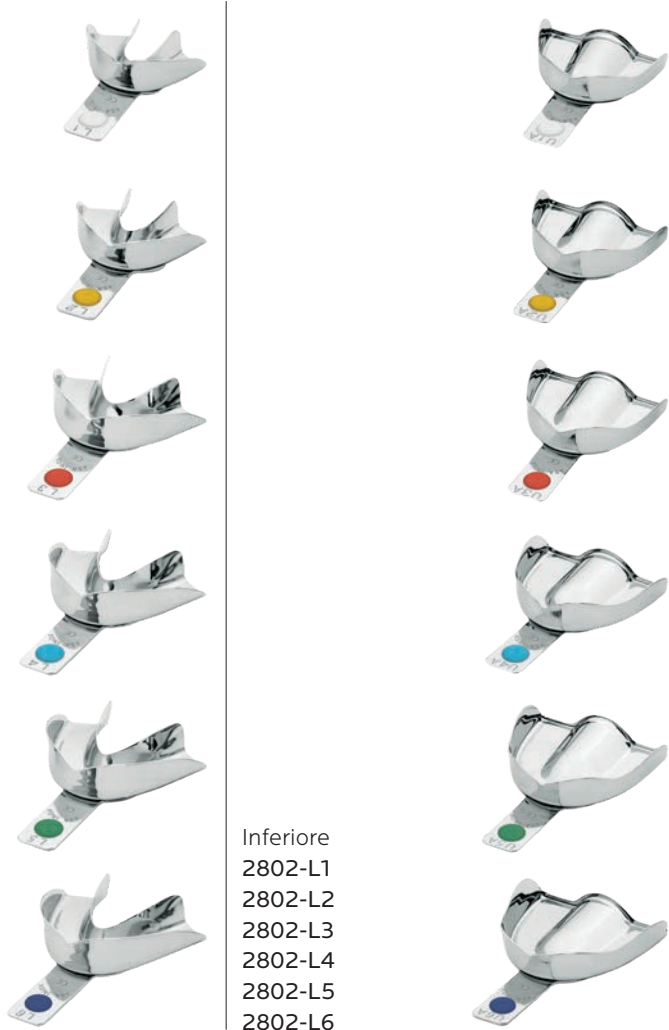

Inferiore
2802-L1
2802-L2
2802-L3
2802-L4
2802-L5
2802-L6



Superiore
2802-U1A
2802-U2A
2802-U3A
2802-U4A
2802-U5A
2802-U6A

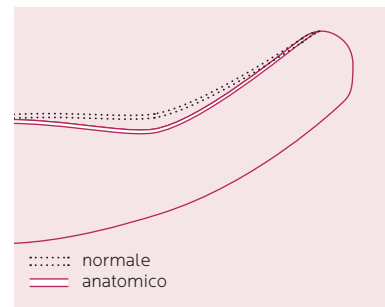

Portaimpronta non forati in acciaio inox - ANATOMIC

senza bordino ritentivo

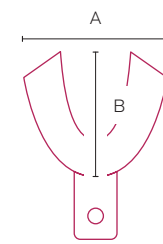

2802 Inferiore		A (mm)	B (mm)
L1	XXS	55	47
L2	XS	60	49
L3	S	72	54
L4	M	74	57
L5	L	76	59
L6	XL	78	61

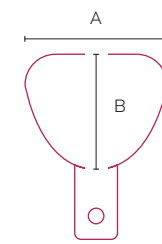

2802A Superiore		A (mm)	B (mm)
U1A	XXS	61	47
U2A	XS	64	51
U3A	S	66	53
U4A	M	69	57
U5A	L	71	60
U6A	XL	73	62



ASA Codicolor

- U1/L1
XXS
- U2/L2
XS
- U3/L3
S
- U4/L4
M
- U5/L5
L
- U6/L6
XL

Portaimpronta forati in alluminio

senza bordino ritentivo

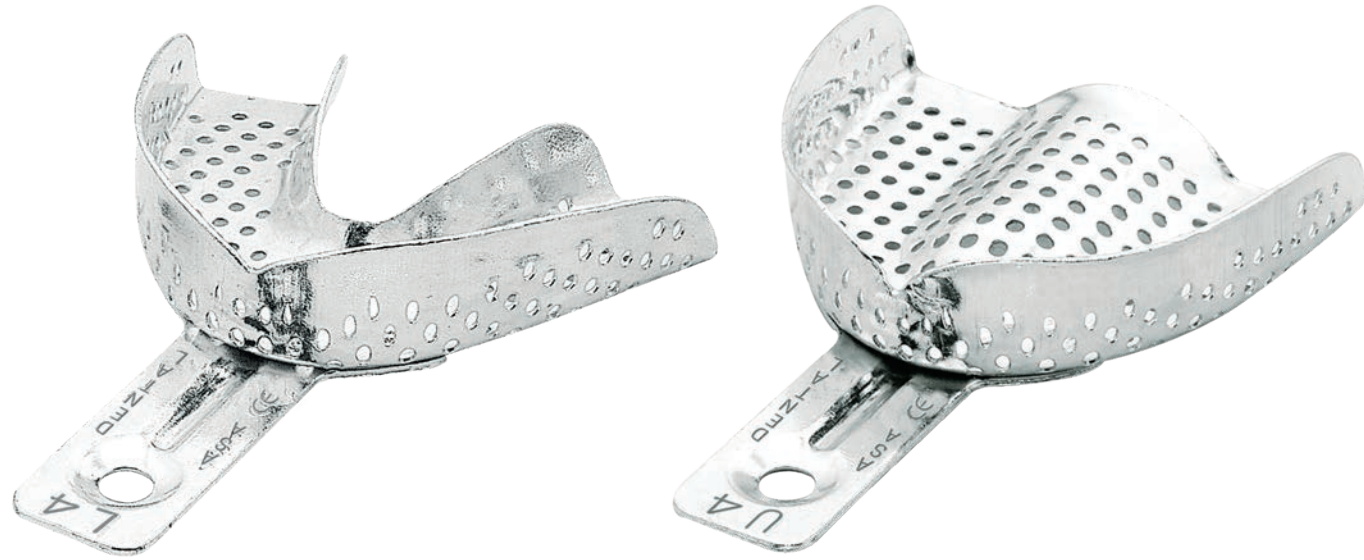

Portaimpronta forati in alluminio

senza bordino ritentivo

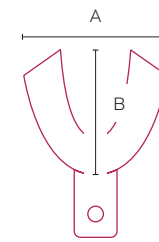

2800 Inferiore		A (mm)	B (mm)
L1	XXS	56	48
L2	XS	59	50
L3	S	72	52
L4	M	76	57
L5	L	77	56
L6	XL	78	59

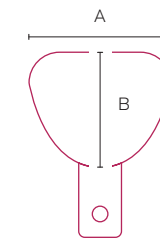

2800 Superiore		A (mm)	B (mm)
U1	XXS	63	48
U2	XS	66	51
U3	S	68	54
U4	M	71	58
U5	L	74	62
U6	XL	76	63

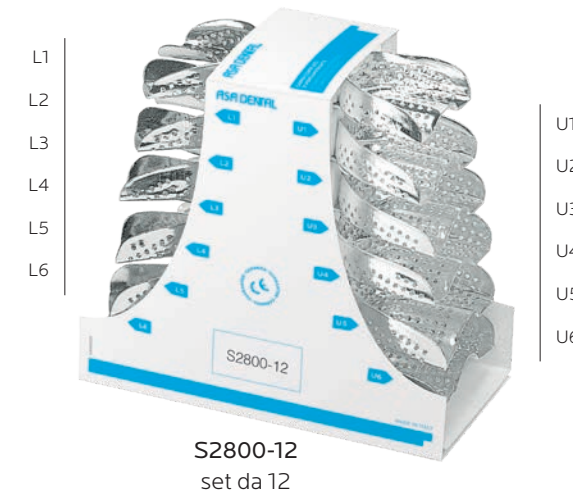
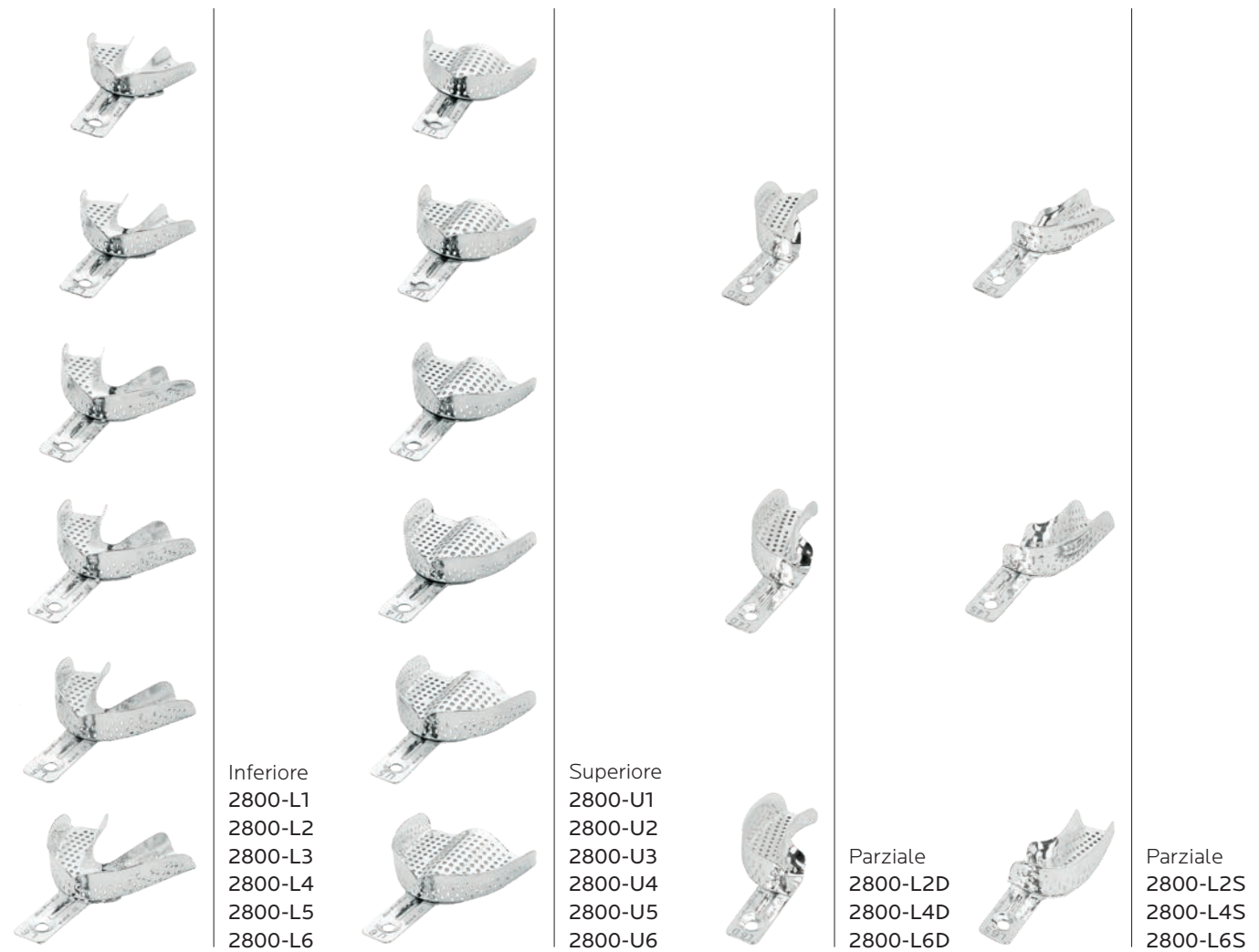

L1
L2
L3
L4
L5
L6

U1
U2
U3
U4
U5
U6

S2800-12
set da 12

Portaimpronta forati in alluminio per implantologia

senza bordino ritentivo

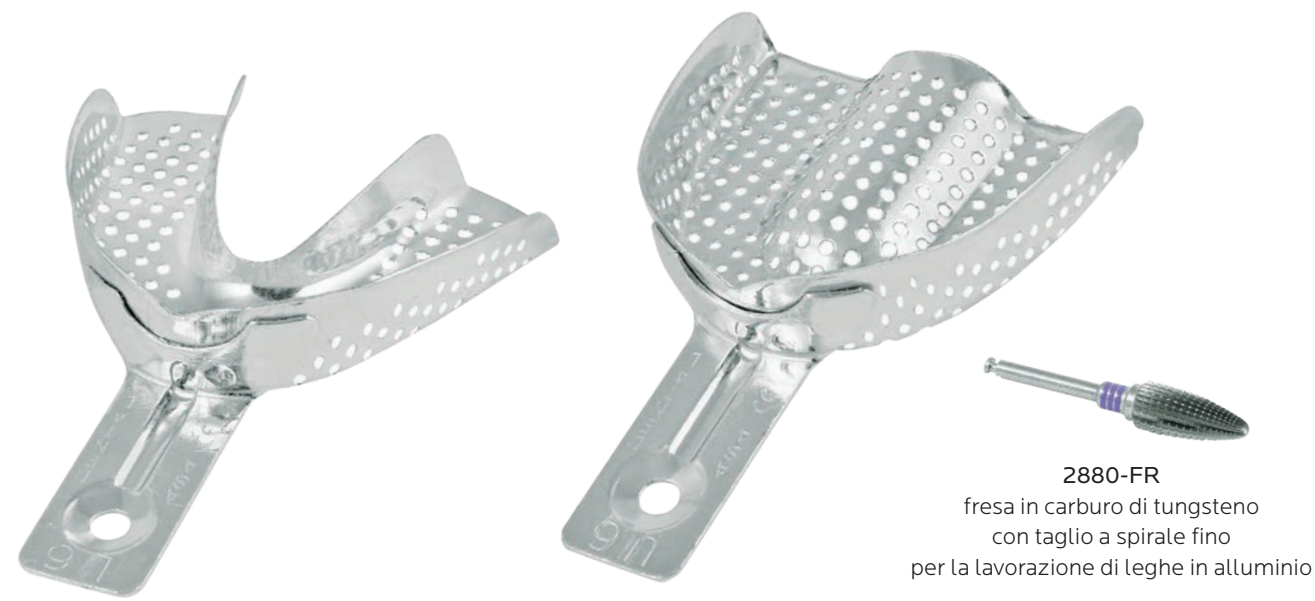

2880-FR
fresa in carburo di tungsteno
con taglio a spirale fino
per la lavorazione di leghe in alluminio



S2880-12
set da 12
S2880-12FR
set da 12 più fresa

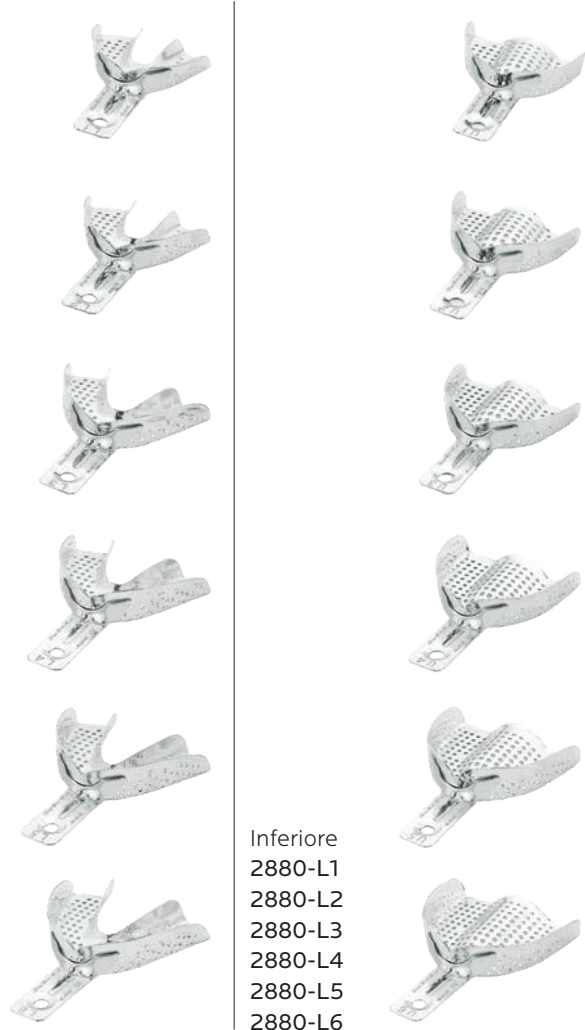

Inferiore
2880-L1
2880-L2
2880-L3
2880-L4
2880-L5
2880-L6

Superiore
2880-U1
2880-U2
2880-U3
2880-U4
2880-U5
2880-U6

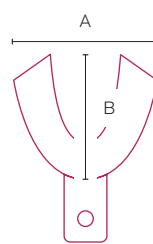

2880 Inferiore		A (mm)	B (mm)
L1	XXS	56	48
L2	XS	59	50
L3	S	72	52
L4	M	76	57
L5	L	77	56
L6	XL	78	59

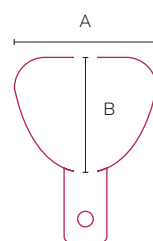

2880 Superiore		A (mm)	B (mm)
U1	XXS	63	48
U2	XS	66	51
U3	S	68	54
U4	M	71	58
U5	L	74	62
U6	XL	76	63

Portaimpronta forati in alluminio - ORTHOBABY per bambini

senza bordino ritentivo

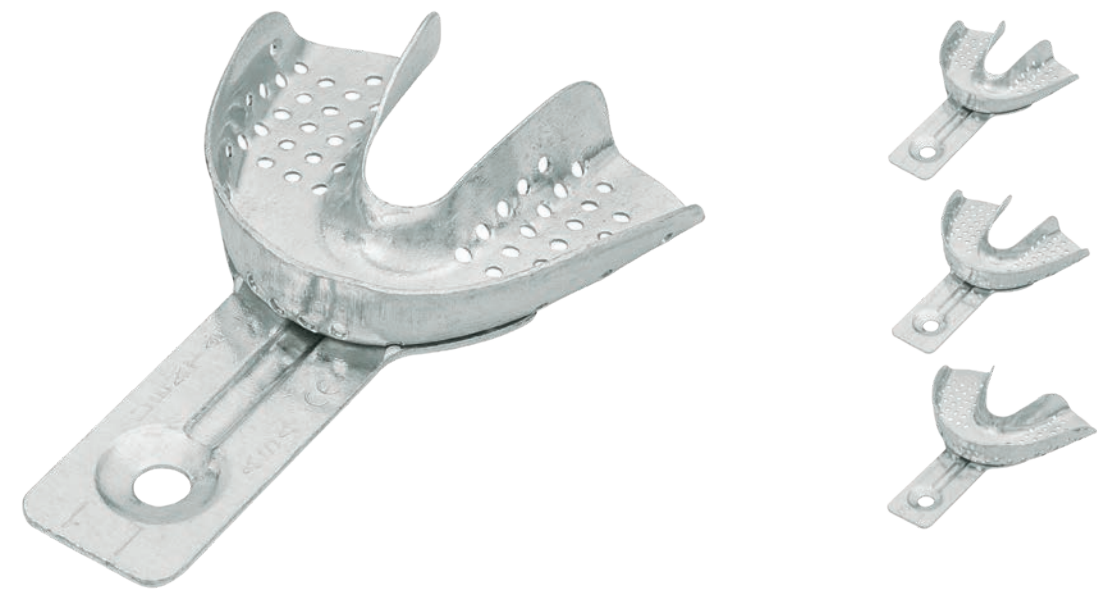

S2816-6
set da 6



Inferiore
2816-L1
2816-L2
2816-L3



Superiore
2816-U1
2816-U2
2816-U3

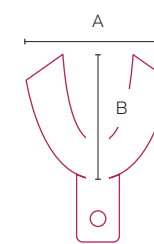

2816 Inferiore		A (mm)	B (mm)
L1	S	55	45
L2	M	60	48
L3	L	69	48

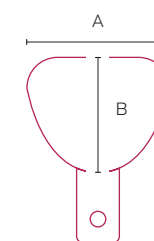

2816 Superiore		A (mm)	B (mm)
U1	S	57	38
U2	M	58	48
U3	L	63	50

Portaimpronta occlusali parziali in acciaio inox

permettono di prendere l'impronta di due semi-arcate antagoniste



2819-OCC



2819-OCP

AsaClean

soluzione pronta all'uso a PH neutro per la rimozione di alginato da portaimpronte e strumenti



8020
contenuto 1000 ml

Portaimpronta forati in alluminio colorate per implantologia

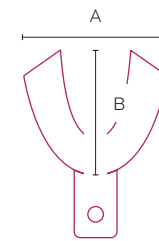

2814 Inferiore		A (mm)	B (mm)
L0	XS	69	50
L1	S	72	57
L2	M	76	57
L3	L	78	59
L4	XL	80	63

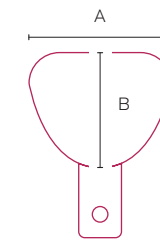

2814 Superiore		A (mm)	B (mm)
U0	XS	65	51
U1	S	67	53
U2	M	71	55
U3	L	74	60
U4	XL	81	63



Inferiore
2814-L0
2814-L1
2814-L2
2814-L3
2814-L4



Superiore
2814-U0
2814-U1
2814-U2
2814-U3
2814-U4

Portaimpronta in policarbonato

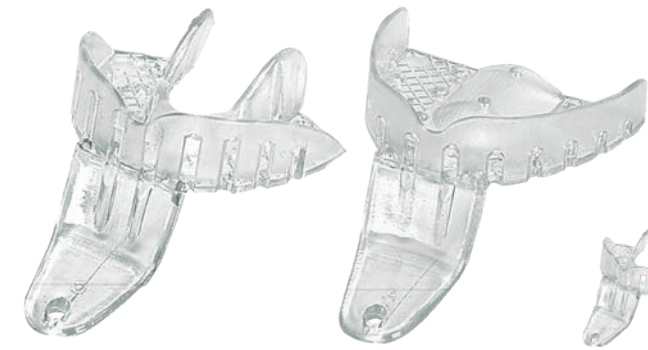

2852-12
set da 12

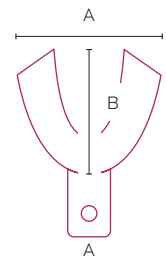

Inferiore	A (mm)	B (mm)
L1	61	50
L2	67	52
L3	72	56
L4	74	58

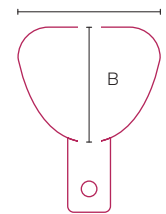

Superiore	A (mm)	B (mm)
U1	61	49
U2	65	53
U3	70	59
U4	73	6

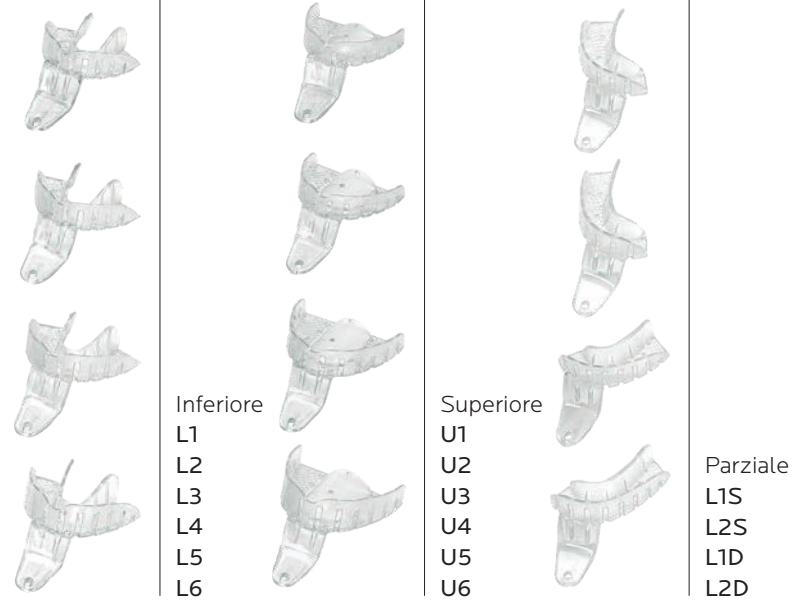

Portaimpronta in policarbonato - edentuli

sterilizzabili in autoclave max. 130°C



S2851-24
set da 24
13x inferiore
7x superiore
4x misti
compasso

2851-13
set da 13
inferiore

2851-7
set da 7
superiore

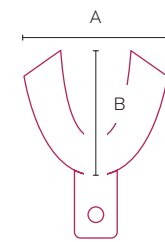

Inferiore	A (mm)	B (mm)
L1	57	49
L2	58	53
L3	60	54
L4	61	55
L5	61	56
L6	61	57
L7	62	57
L8	64	55
L9	64	59
L10	66	57
L11	65	60
L12	67	58
L13	70	59

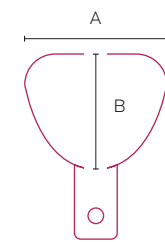

Superiore	A (mm)	B (mm)
U1	62	54
U2	63	58
U3	64	58
U4	66	60
U5	70	62
U6	75	63
U7	77	64

MIXED	A (mm)	B (mm)
U1P	64	63
U2P	67	57
L1C	75	49
L2C	76	53

Portaimpronta ortodontici in policarbonato - ORTHOBABY per bambini



2850-8
set da 8

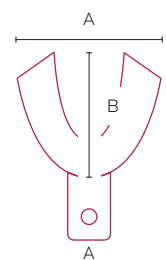

Inferiore	A (mm)	B (mm)
L1	52	44
L2	58	49
L3	62	53
L4	66	56

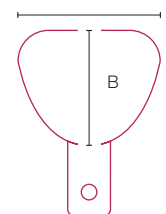

Superiore	A (mm)	B (mm)
U1	50	46
U2	56	51
U3	59	55
U4	63	59

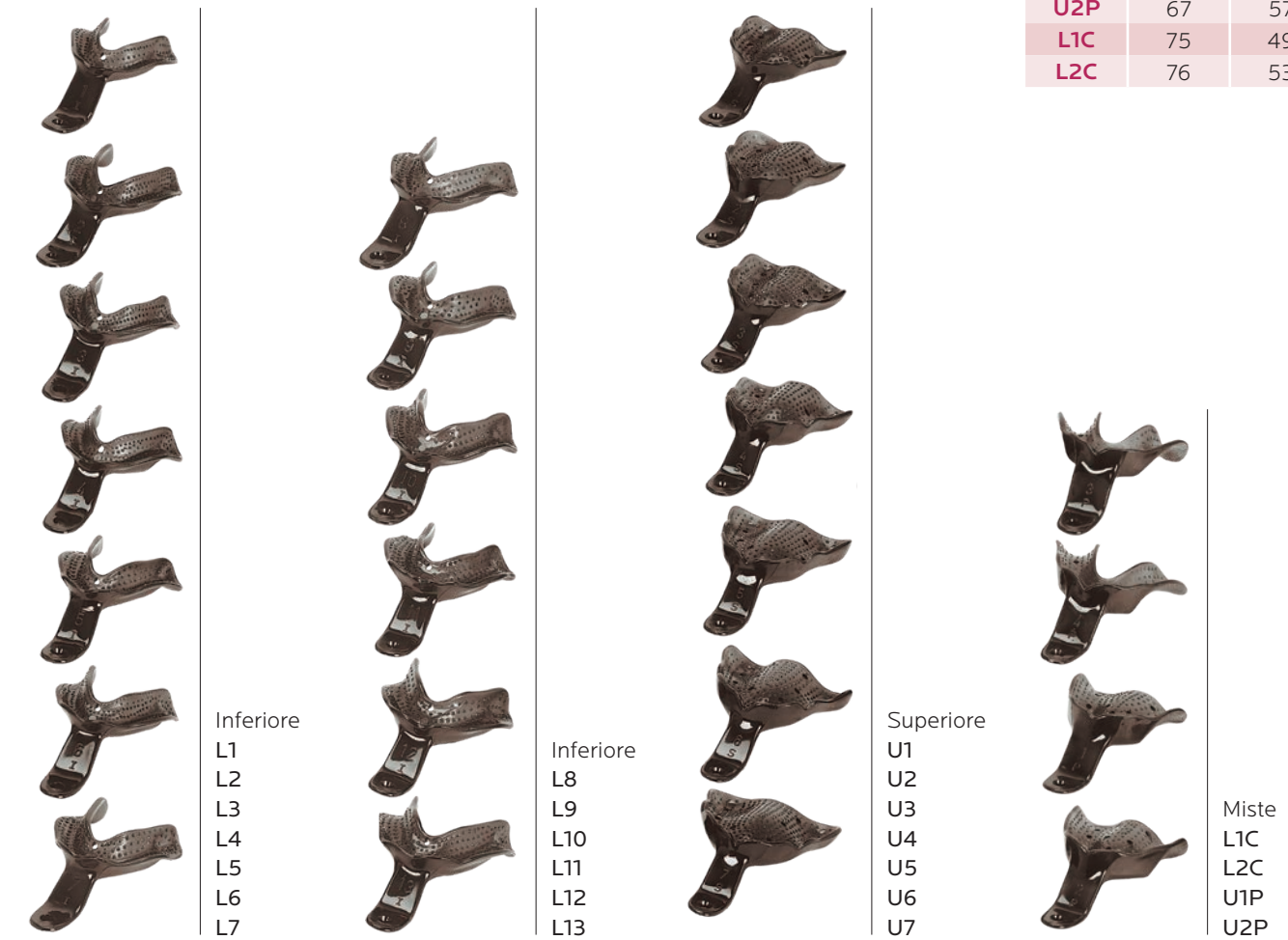
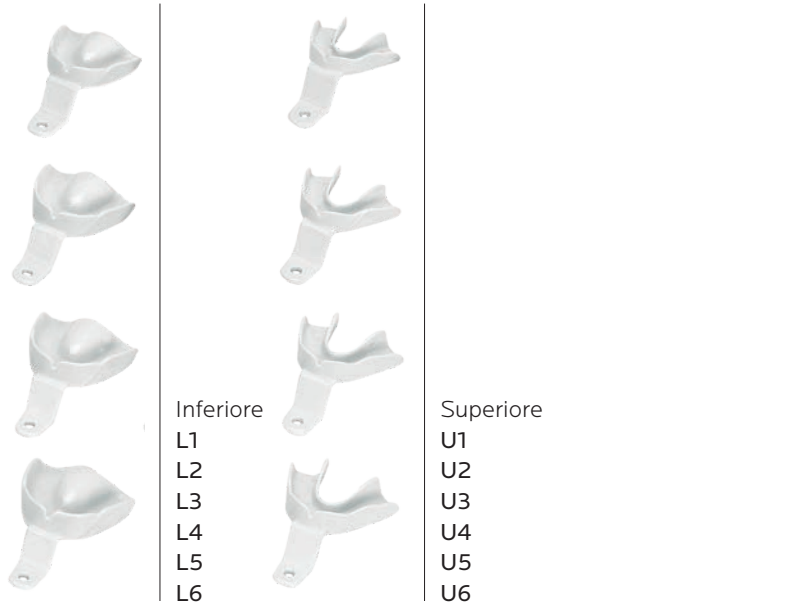



STRUMENTI PER LABORATORIO

MADE IN ITALY



LA FORMULA VINCENTE: OTTIMA COMPETENZA E TECNICA AVANZATA

Per ottenere risultati insperati e trasformare impronte dentali in protesi efficaci è fondamentale il lavoro che un odontotecnico svolge dietro le quinte. Sulla base di precise informazioni che comprendono dettagli anatomici e funzionali, il lavoro dello specialista integra competenze tecniche, capacità artistiche, materiali avanzati e strumenti di elevata precisione per creare qualsiasi tipo di ricostruzione, incluse corone, ponti, protesi parziali, complete o rimovibili.

Gli strumenti per laboratorio di Asa Dental spaziano da articolatori a valori medi estremamente versatili, attraverso un'ampia gamma di accessori, fino a strumenti di modellazione precisi, tutti necessari per creare le forme migliori e aiutare gli esperti a ripristinare l'aspetto estetico e funzionale della bocca dei loro pazienti.

- K2 Articolatori
- K10 Easy Bow
- K13 Strumenti per modellare cera
- K18 Strumenti per cera
- K19 Pinzette
- K20 Pennelli per ceramica
- K21 Strumenti per ceramica
- K22 Coltelli
- K24 Spatole e tazze
- K27 Contenitori per protesi
- K28 Forbicine
- K29 Strumenti per corone
- K30 Calibri
- K31 Martelli
- K32 Pinze per cilindri e muffole
- K33 Sehetti e lame
- K34 Kit

ARTICOLATORI valori medi

Progettati per semplificare e velocizzare le operazioni su qualsiasi modello, il 5050 e il 5050Plus sono articolatori non-Arcon a valori medi che rispondono con assoluta precisione alle esigenze dei professionisti, indipendentemente dalla tecnica di protesizzazione utilizzata. La struttura leggera, stabile ed ergonomica facilita set-up e lavoro sia partendo dall'arcata superiore che da quella inferiore, con la possibilità di lavorare comodamente inclinando l'articolatore a 60°. Le caratteristiche di questi articolatori permettono di simulare esattamente il tragitto condiloideo per garantire quella precisione che dona a protesi e ricostruzioni dentali funzionalità e occlusione ottimali, qualunque sia il movimento mandibolare del paziente.

L'articolatore 5050 permette di lavorare efficacemente su protesi e modelli di diverse misure ed è compatibile con i polimerizzatori a pressione disponibili in commercio. Progettato pensando all'ergonomia dell'operatore, offre una stabilità totale nella posizione di lavoro standard, in quella a 60° che privilegia il comfort dell'operatore, ma anche ruotato sottosopra, nel caso di pazienti edentuli in classe III. Il sistema anti-rotazione dell'asta incisale garantisce un posizionamento non solo preciso ma anche corretto, mentre l'asta antiribaltamento assicura la necessaria stabilità quando la branca superiore è completamente aperta. Il piano oclusale e le calotte hanno 4 linee ellittiche di riferimento per assistere nel corretto posizionamento del modello indipendentemente dalle dimensioni, sia partendo dall'arcata superiore che da quella inferiore.

CARATTERISTICHE TECNICHE

- design per posizione di lavoro ergonomica a 60°
- ideale per pazienti di classe III
- compatibile per dimensione con i polimerizzatori a pressione in commercio
- sistema anti-rotazione per asta incisale
- calotta con 4 traiettorie ellittiche di riferimento per modelli a partire da arcata inferiore
- piano oclusale con 4 traiettorie ellittiche di riferimento per modelli a partire da arcata superiore
- asta antiribaltamento per stabilità ad apertura completa
- sistema di protezione antishock

DATI TECNICI

distanza intercondilare	110 mm
inclinazione condilare fissata a	30°
angolo di Bennett	0 - 7°
inclinazione base incisale	10°
distanza fra le piastrine di montaggio	87 mm
apertura	180°

INCLUDE

4 piastrine di montaggio	5000-1
2 viti di serraggio	5011-6



5050

ARTICOLATORI valori medi

Il 5050Plus è sicuramente l'articolatore più versatile tra quelli che compongono la linea di prodotti per laboratorio di Asa Dental. In aggiunta alle prestazioni offerte dal 5050, il 5050Plus offre il vantaggio dell'esclusivo sistema ad asta posteriore con piano inclinato che garantisce assoluta precisione anche quando, per aumentare la visibilità, l'operatore rimuove l'asta incisale: la vite di regolazione posteriore conserva inalterate le traiettorie e le inclinazioni durante le varie combinazioni dei movimenti di lateralità, protrusione e retrusione. Completa la configurazione un sistema ad asta incisale magnetica che previene qualsiasi alterazione del modello durante le fasi di solidificazione del gesso. Semplice, preciso ed ergonomico, il 5050Plus è la risposta più efficace da parte di Asa Dental a tutti gli odontotecnici che richiedono un articolatore a valori medi non-Arcon versatile e affidabile.

CARATTERISTICHE TECNICHE

- design per posizione di lavoro ergonomica a 60°
- ideale per pazienti di classe III
- compatibile per dimensione con i polimerizzatori a pressione in commercio
- sistema anti-rotazione per asta incisale
- sistema con asta posteriore regolabile per lavorazioni precise anche senza asta incisale
- calotta con 4 traiettorie ellittiche di riferimento per modelli a partire da arcata inferiore
- piano oclusale con 4 traiettorie ellittiche di riferimento per modelli a partire da arcata superiore
- asta incisale magnetica per stabilità totale durante la cristallizzazione del gesso
- asta antiribaltamento per stabilità ad apertura completa
- sistema di protezione antishock

DATI TECNICI

distanza intercondilare	110 mm
inclinazione condilare fissata a	30°
angolo di Bennett	0 - 7°
inclinazione base incisale	0°
distanza fra le piastrine di montaggio	87 mm
inclined contrast table	24°
apertura	180°

INCLUDE

4 piastrine di montaggio	5000-1
2 viti di serraggio	5011-6



5050Plus

ARTICOLATORI valori medi

Articolatore anatomico in lega di alluminio pressofuso utilizzabile con il piano di Camper o con arco facciale arbitrario; bloccaggio in relazione alla centrica; ritorno automatico in asse cerniera con molle di richiamo; perfetta stabilità in posizione aperta; asse cerniera con antishock che preserva l'asse cerniera da rottura o grave danneggiamento in caso di caduta accidentale dell'articolatore; viti maggiorate per piastre; le spalle posteriori hanno un andamento anatomico che favorisce una salda e pratica tenuta dell'articolatore

CARATTERISTICHE TECNICHE

- altezza e larghezza maggiori
- più spazio quando si usano i sistemi per monconi sfilabili
- più spazio per il montaggio delle protesi mobili con masticazioni alte o zoccoli grandi
- più spazio quando si utilizzano le piastrine magnetiche
- migliore accesso posteriore
- distanza di lavoro interna variabile
- asta incisale ed asta antiribaltamento in acciaio
- asse cerniera in acciaio
- protezione con sistema antishock

DATI TECNICI

distanza intercondilare	120 mm
inclinazione condilare fissata a	30°
angolo di Bennett fissato a	7°
inclinazione base incisale	10°
distanza fra le piastrine di montaggio	90-110 mm
peso	700 gr
apertura	180°

INCLUDE

2 distanziatori	5030-29
4 piastrine di montaggio	5000-1
2 viti di serraggio per distanziatore	5030-6
2 viti di serraggio per piastrine	5011-6

ACCESSORI

arco facciale	5021
tavolo di trasferimento	5024
piano di occlusione	5030-2
taratore	5033



5030

ARTICOLATORI valori medi

Il 5032 ha le stesse caratteristiche del 5030 più:
asta posteriore regolabile con vite micrometrica di registro, per lavorare con asta incisale rimossa, con mantenimento inalterato delle traiettorie e inclinazioni nei movimenti di lateralità e protrusiva/retrusiva; movimento di traslazione pura (istruzioni e chiave per l'attivazione fornite insieme al prodotto)

CARATTERISTICHE TECNICHE

- asta posteriore sulla parte superiore per accesso e visibilità posteriore inalterati
- asse cerniera con possibilità di movimento traslazione pura

DATI TECNICI

distanza intercondilare	120 mm
inclinazione condilare fissata a	30°
angolo di Bennett fissato a	7°
inclinazione base incisale	10°
distanza fra le piastrine di montaggio	90-110 mm
peso	700 gr
apertura	180°

INCLUDE

2 distanziatori	5030-29
2 piastrine magnetiche	5000-1M
2 viti di serraggio per distanziatore	5030-6
2 viti di serraggio per piastrine	5011-6

ACCESSORI

arco facciale	5021
tavolo di trasferimento	5024
piano di occlusione	5030-2
taratore	5033



5032

ARTICOLATORI valori medi

INCLUDE

2 piastrine di montaggio	5000-1
2 viti di serraggio per piastrine	5050-6



5002

occlusore

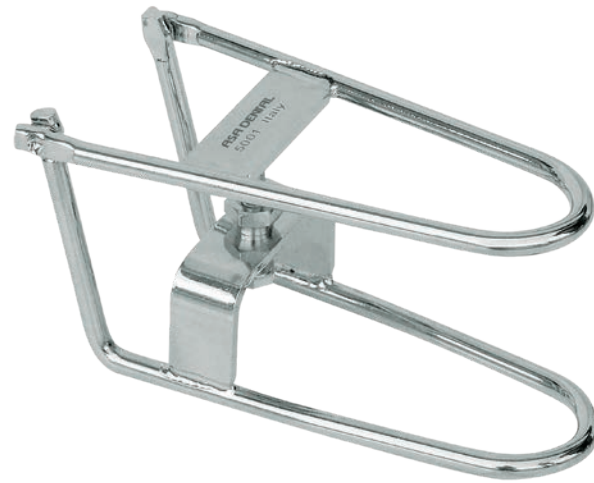

5001

parti di ricambio

piastrina di montaggio
piastrina in pressofusione in alluminio
utilizzabile sugli articolatori

5050
5050Plus
5030
5032
5002
5000
5010
5011



5000-1

ARTICOLATORI parti di ricambio



5000-26
magnete



5000-26

5000-30
camicia porta magnete



5000-30

5000-1M
• piastrina pressofusa
in alluminio teflonato
• camicia porta magnete (5000-30)
• magnete (5000-26)
utilizzabile sugli articolatori
5050
5050Plus
5030
5032
5002
5000
5010
5011



5000-1M



5000-30



5000-26

5000-25
contromagnete per gesso
per piastrina pressofusa
in alluminio teflonato
10 pz / confezione



5000-25

5030-29
distanziatore
utilizzabile sugli articolatori
5030
5032



5030-29

ARTICOLATORI
parti di ricambio

5050Plus

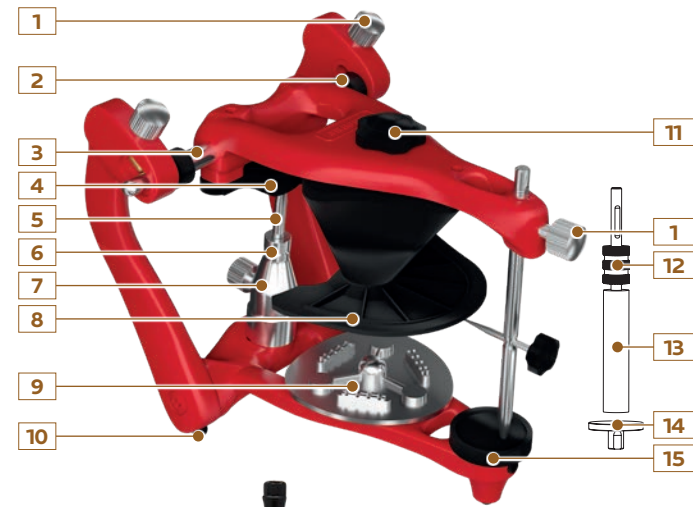

5050

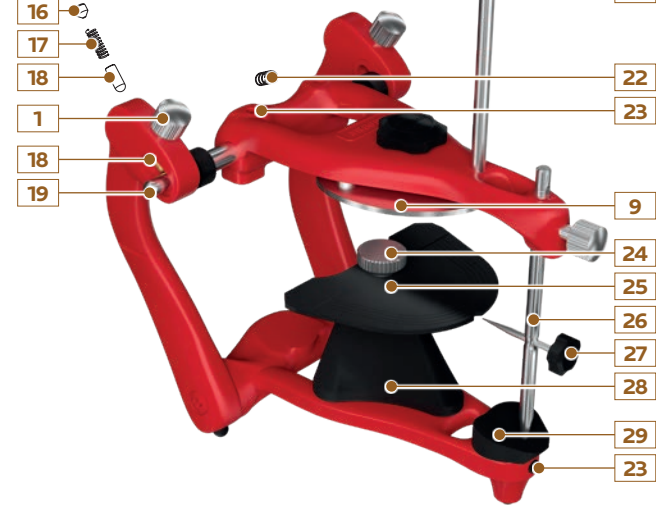

5030/5032

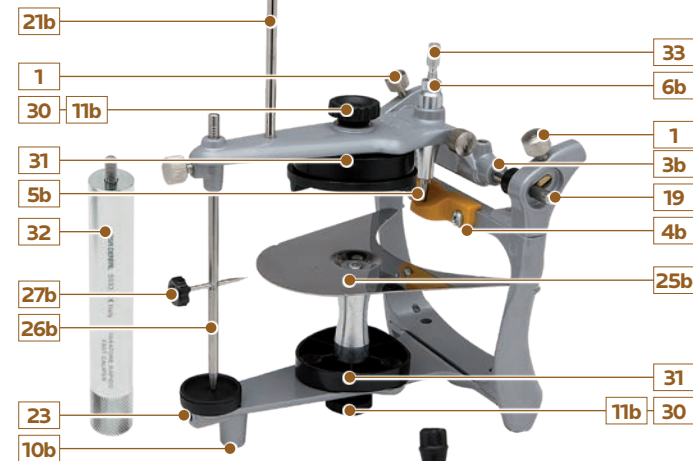

5000/5010

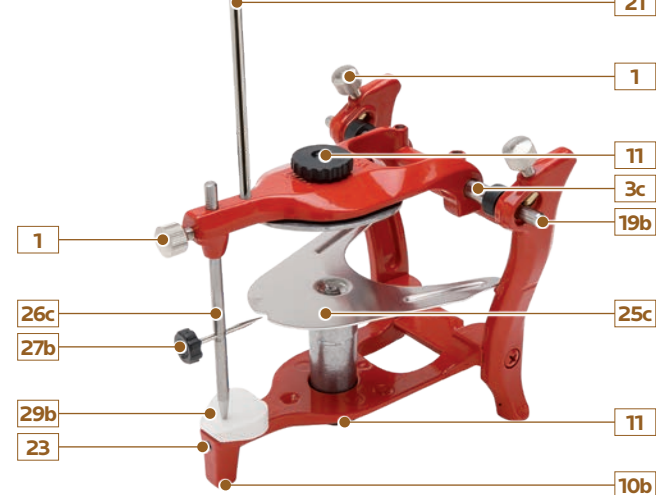

5011

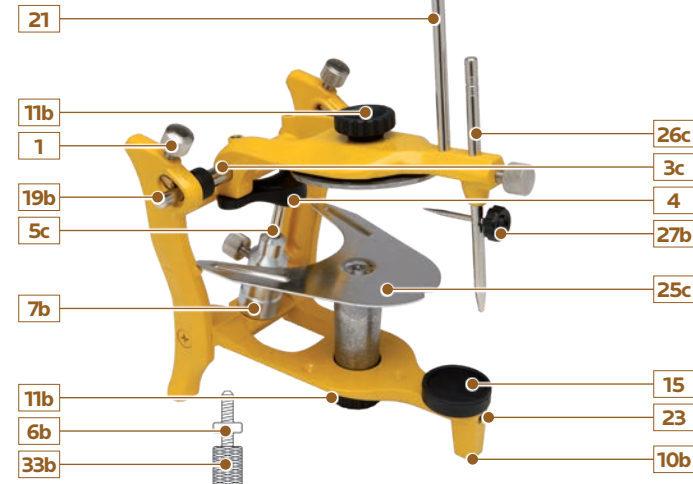

ARTICOLATORI
parti di ricambio

		MODELLI DISPONIBILI					MODELLI OBSOLETI		
		5050Plus	5050	5032	5030	5002	5011	5010	5000
1	pomello metallico di serraggio	5000-5	5000-5	5000-5	5000-5		5000-5	5000-5	5000-5
2	rondella di rasamento asse cerniera	5011-18	5011-18	5011-18	5011-18		5011-18	5011-18	5011-18
3,3b,3c	asse cerniera	5050-17	5050-17	5032-17	5032-17		5011-17	5011-17	5011-17
4,4b	piano inclinato di contrasto	5011-16		5032-16			5011-16		
5,5b,5c	asta posteriore	5050-21		5032-21			5011-21		
6,6b	contro vite	5011-23		5032-23			5011-23		
7,7b	porta asta posteriore	5050-20					5011-20		
8	calotta	5052	5052						
9	piastrina di montaggio	5000-1	5000-1	5000-1	5000-1	5000-1	5000-1	5000-1	5000-1
10,10b	pieдини in gomma (6 pz / confezione)	5050-24	5050-24	5000-24	5000-24		5000-24	5000-24	5000-24
11,11b	vite di serraggio	5050-6	5050-6	5011-6	5011-6	5050-6	5011-6	5050-6	5050-6
12	ghiera per asta	5053-2							
13	asta con magnete incollato	5053-1							
14	piano per asta magnetica	5053-3							
12+13+14	kit asta magnetica	5053							
15	piano incisale (0°)	5011-4		5011-4			5011-4		
16	vite per regolazione molla movimenti laterali	5000-7	5000-7	5000-7	5000-7		5000-7	5000-7	5000-7
17	molla per movimenti laterali	5000-12	5000-12	5000-12	5000-12		5000-12	5000-12	5000-12
18	cilindro per movimenti laterali	5000-13	5000-13	5000-13	5000-13		5000-13	5000-13	5000-13
19,19b	asta movimento condilare	5030-9	5030-9	5030-9	5030-9		5011-9	5011-9	5011-9
20	cappuccio in gomma	5011-11	5011-11	5011-11	5011-11		5011-11	5011-11	
21,21b	asta antiribaltamento	5010-10	5010-10	5030-10	5030-10		5010-10	5010-10	
22	molla interna asse cerniera	5011-19	5011-19	5011-19	5011-19		5011-19	5011-19	5011-19
23	viti M5 per fissaggio base incisale	5000-18	5000-18	5000-18	5000-18		5000-18	5000-18	5000-18
24	vite zigrinata per piano oclusale e calotta	5050-4	5050-4						
25,25b,25c	piano di occlusione	5051	5051	5030-2	5030-2		5000-2	5000-2	5000-2
26,26b,26c	asta incisale	5050-3	5050-3	5030-3	5030-3		5000-3	5000-3	5000-3
27,27b	indicatore incisale	5050-8	5050-8	5000-8	5000-8		5000-8	5000-8	5000-8
28	supporto per piano oclusale e calotta	5050-2	5050-2						
24+25+28	piano oclusale completo (5050-4 + 5051 + 5050-2)	5054	5054						
29,29b	piano incisale (10°)		5000-4N		5000-4			5000-4	5000-4
30	vite di serraggio per distanziatore			5030-6	5030-6				
31	distanziatore			5030-29	5030-29				
32	taratore			5033	5033				
33,33b	vite micrometrica di registrazione			5032-22			5011-22		
34	piastrina magnetica completa	5000-1M	5000-1M	5000-1M	5000-1M	5000-1M	5000-1M	5000-1M	5000-1M
35	magnete	5000-26	5000-26	5000-26	5000-26	5000-26	5000-26	5000-26	5000-26
36	contromagneti per gesso (10 pz / confezione)	5000-25	5000-25	5000-25	5000-25	5000-25	5000-25	5000-25	5000-25
37	camicia porta magnete	5000-30	5000-30	5000-30	5000-30	5000-30	5000-30	5000-30	5000-30

Easy Bow

5020

set completo arco facciale corredato di tre forchette con tavolo di trasferimento per articolatore

arco facciale	5021
blocco porta forchetta	5022
tavolo di trasferimento	5024
forchetta	5023-1
forchetta	5023-2
forchetta	5023-3

set utilizzabile sugli articolatori

5030

5032



5021



5022

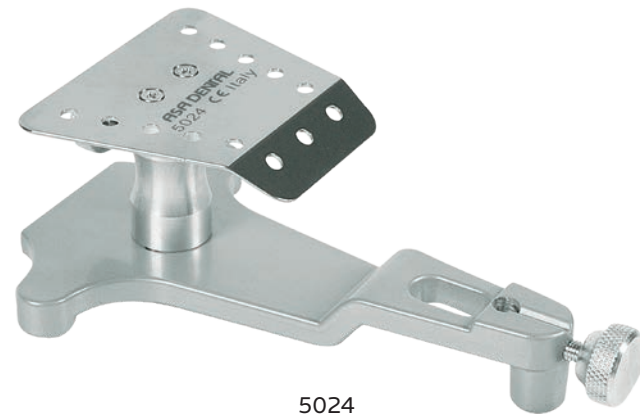

5024



5023-1



5023-2



5023-3

Easy Bow

istruzioni d'utilizzo

1. Inserire il blocco porta forchetta nell'arco
2. inserire la forchetta nella bocca del paziente
3. tirare le estremità delle olive auricolari verso l'esterno e inserire l'arco

**Easy Bow**

istruzioni d'utilizzo

4. regolare la posizione del Nasion tenendo a riferimento il piano di Francoforte
5. collegare l'asta porta forchetta e serrare tutti i pomelli
6. arco facciale inserito

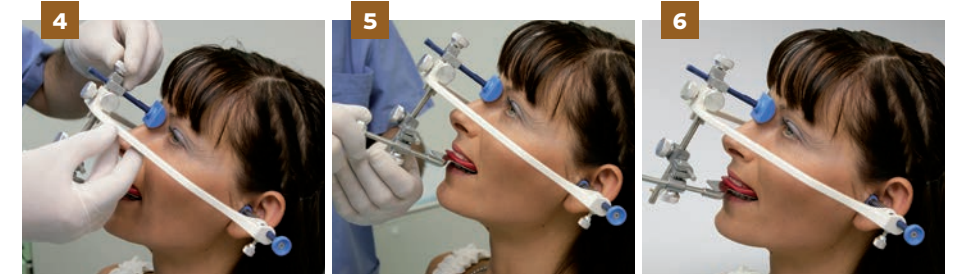

7. tirare le estremità delle olive auricolari verso l'esterno ed estrarre l'arco
8. allentare il pomello ed estrarre il blocco porta forchetta
9. posizionare il blocco porta forchetta nel tavolino di trasferimento...

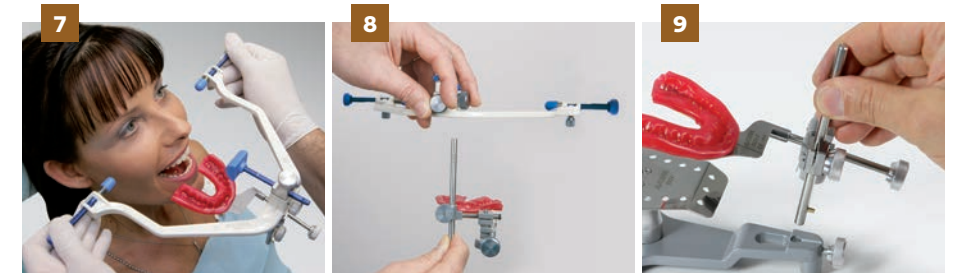

10. ...e serrare il pomello
11. se necessario regolare l'altezza del pianetto; successivamente rimuovere il blocco porta forchetta
12. Porre il gesso sul pianetto e riposizionare il blocco porta forchetta



13. dopo che il gesso è indurito allentare il pomello dell'asta porta forchetta...
14. ...ed estrarre l'asta
15. allentare il pomello ed estrarre il blocco porta forchetta



16. posizionare il tavolo sull'articolatore...
17. ...inserendolo negli appositi alloggi
18. fissare il tavolo sull'articolatore con la vite già in dotazione all'articolatore



19. posizionare il modello sul "morso"
20. porre il gesso sul modello...
21. ...concludere la "messa in articolatore" come di norma



Manici

PUNTA SINGOLA

● Alu80
(alluminio, vuoto)
ø 8,0 mm



PUNTA DOPPIA

Asa60
(acciaio inox)
ø 6,0 mm



Asa Light MV
(acciaio inox, vuoto)
ø 8,0 mm



● Alu80
(alluminio, vuoto)
ø 8,0 mm



● Magic Color MC
(anima in alluminio e
plastica antiscivolo)
ø 8,0 / 10,5 mm



Strumenti per modellare



1/2 Hollenback
1500-02
Asa60
MV1500-02
Asa Light MV
MC1500-02

● Magic Color MC

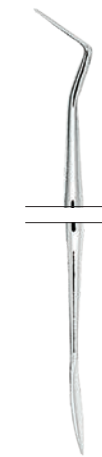

1 Ward
1501-1
Asa60
MV1501-1
Asa Light MV

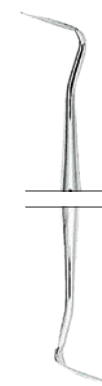

3 Hollenback
1500-3
Asa60
MV1500-3
Asa Light MV



1S Ward
1501-1S
Asa60
MV1501-1S
Asa Light MV



3S Hollenback
1500-3S
Asa60
MV1500-3S
Asa Light MV

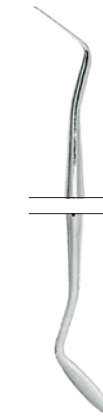

2 Ward
1501-2
Asa60
MV1501-2
Asa Light MV



1 Frahm
1502-1
Asa60
MV1502-1
Asa Light MV



2 USC
1503-2
Asa60

Strumenti per modellare

Strumenti per modellare



Hylin
manico millimetrato
in mm
5100-1

Hylin
5100

Hylin-Le Cron
5101

Hylin-Ceramica
5102

Hylin-ASA
5103

ASA
5104

Le Cron
5105

Le Cron
5106

Le Cron
5107

Le Cron
5108

Zahle
5109

Zahle
5110

Strumenti per modellare

Strumenti per modellare

set da 5

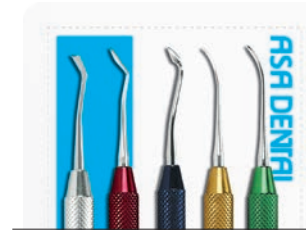

1 · 2 · 3 · 4 · 5
S5112
Asa60
1AL · 2AL · 3AL · 4AL · 5AL
S5112AL
Alu80



Zahle
5111



Gritman
5113



Beale
5114



Roach
5115



Vehe
5116



1 P.K. Thomas
5112-1
Asa60

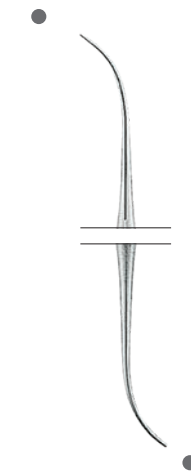

2 P.K. Thomas
5112-2
Asa60



3 P.K. Thomas
5112-3
Asa60

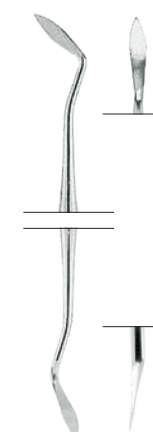

4 P.K. Thomas
5112-4
Asa60

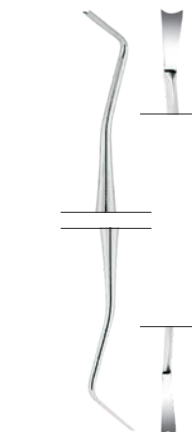

5 P.K. Thomas
5112-5
Asa60



1 P.K. Thomas
5112-1AL
Alu80



2 P.K. Thomas
5112-2AL
Alu80



3 P.K. Thomas
5112-3AL
Alu80

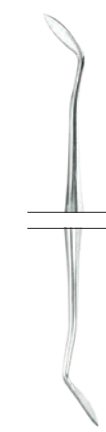

4 P.K. Thomas
5112-4AL
Alu80

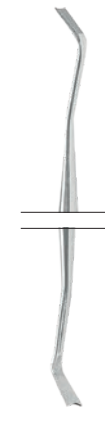

5 P.K. Thomas
5112-5AL
Alu80

Strumenti per cera con punte intercambiabili

set da 3+3



1 · 2 · 3 · 1C · 2C · 3C
S5160

Pinzette per laboratorio



1
S5160-1C
● Alu80



2
S5160-2C
● Alu80



3
S5160-3C
● Alu80



1
5160-1



2
5160-2



3
5160-3



1
16,5 cm
6400-1



2
16 cm
6400-2



3 Meriam
16 cm
0601-3



2
12 cm
0645-2



3
11,5 cm
0645-3



3
15 cm
0635-3



4
18 cm
0635-4



6
26 cm
0635-6

Pennelli per ceramica



7000-6 7000-8 7001-3 7001-1 7001-0 7001-00 7002-4 7002-6 7002-8

Strumenti per ceramica e resine di rivestimento

set da 3 manici + 6 punte



5150-1 · 5150-2 · 5150-3
5156-1 · 5156-2 · 5156-3
5150



5151-1 · 5151-2 · 5151-3
5156-1 · 5156-2 · 5156-3
5151



1 5150-1 ● Alu80 2 5150-2 ● Alu80 3 5150-3 ● Alu80
1 Greenstein 5151-1 ● Alu80 2 Greenstein 5151-2 ● Alu80 3 Greenstein 5151-3 ● Alu80

PUNTE FLESSIBILI PUNTE SUPERFLESSIBILI



1 5155-1 1 5156-1
2 5155-2 2 5156-2
3 5155-3 3 5156-3

Coltelli per cera

Coltelli per gessi



CON SCODELLINO CON SCODELLINO

- 1 Fahnenstock 12,5 cm 5200-1
- 2 Fahnenstock 17 cm 5200-2
- 1 Lessmann 12,5 cm 5201-1
- 2 Lessmann 17 cm 5201-2
- 1 12,5 cm 5202-1
- 2 17 cm 5202-2
- 1 17 cm 5300-1
- 2 Gritman 17 cm 5300-2
- 3 16 cm 5300-3
- 4 16 cm 5300-4

il colore del manico può essere soggetto a variazione cromatica

il colore del manico può essere soggetto a variazione cromatica

Spatole rigide per alginato, gesso ed elastomeri

alginato, gesso

alginato

elastomeri

Spatole flessibili per alginato, gesso ed elastomeri

alginato, gesso

alginato

elastomeri



1
18,5 cm
5400-1

2
18 cm
5400-2

8
20 cm
5400-8

9
22,5 cm
5400-9

3
18,5 cm
5400-3

5
21,5 cm
5400-5

6
20,5 cm
5400-6

7
19,5 cm
5400-7

4
19,5 cm
5400-4

il colore del manico può essere soggetto a variazione cromatica

il colore del manico può essere soggetto a variazione cromatica

Spatole per alginato e gesso



19 cm 5401-B 19 cm 5401-C 19 cm 5401-F 19 cm 5401-G 19 cm 5401-R 19 cm 5401-V

Tazze per alginato e gesso



Ø 160 mm Ø 140 mm Ø 120 mm Ø 100 mm

2,2 L 5500-16 0,9 L 5500-14 0,5 L 5500-12 0,35 L 5500-10



Ø 160 mm Ø 140 mm Ø 120 mm Ø 100 mm

2,2 L 5501-16 0,9 L 5501-14 0,5 L 5501-12 0,35 L 5501-10

Contenitori per protesi/ortodontici

scatolina in plastica antiurto per apparecchi ortodontici mobili
10 pz / confezione



Blu
6900E-A



Bianco
6900E-B



Celeste
6900E-C



Giallo
6900E-G



Rosa
6900E-R



Verde
6900E-V

Forbicine

per fogli d'oro



1
retta
12 cm
0300-1



2
curva
12 cm
0300-2



forbicine universali
una lama dentellata

Universale
12 cm
5700

Forbicine per corone



1
retta
una lama dentellata
10,5 cm
5600-1



2
curva
una lama dentellata
10,5 cm
5600-2



1
retta
10,5 cm
5601-1



2
curva
10,5 cm
5601-2

Strumenti per corone



13 cm
0545-1

pinze telescopiche per corone

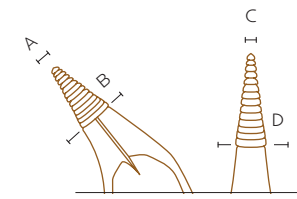

A	4,4 mm
B	5,0 mm

C	3,4 mm
D	3,8 mm

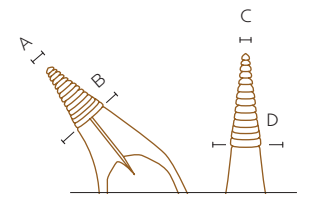

A	3,3 mm
B	4,0 mm

C	2,3 mm
D	3,0 mm



Böhm
14,5 cm
2500-2



Böhm
11,5 cm
2500-1

Calibri

calibri con molla

scala di misurazione: 0-10 mm



**Iwanson
per cera
2550-1**

scala di misurazione: 0-10 mm



**Iwanson
per metallo
2550-2**

scala di misurazione: 0-15 mm



**18 cm
2557-1**

calibri decimali

scala di misurazione:
0-200 mm / 0-7 in

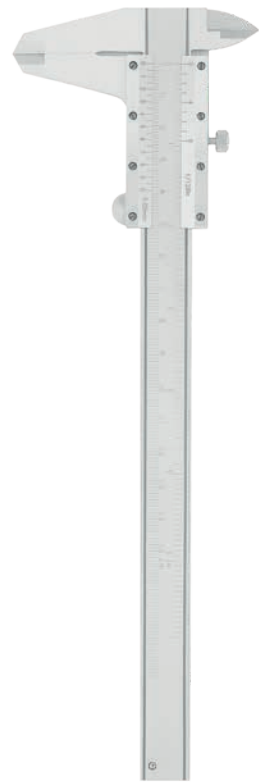

**alluminio
divisione in millimetri
e pollici
2556-1**

scala di misurazione:
0-200 mm / 0-4 in



**Townley
divisione in millimetri
e pollici
2556-2**

scala di misurazione:
0-200 mm / 0-4 in



**Jameson
divisione in millimetri
e pollici
2556-3**

scala di misurazione:
0-100 mm



**Boley
14 cm
2555**

Cesoia taglia gesso



**Asa Special Inox
19,5 cm
5900**

Martelli

martelletti per rivettare



**22 cm
6000**



**22 cm
6001**

martelletto con punta in corno



**20 cm
6002**

misure indicative

Pinze per cilindri e muffole



31 cm
6600-5



40 cm
6600-4



51 cm
6600-2

Seghetti e Lame

seghetto



25 cm
6200

lame seghetto
12 pz / confezione

130 mm x Ø 1,3 mm
per gesso
6201-1

130 x 0,52 x 0,26 mm
per metallo
6201-2

seghetto per modelli



18 cm
6300

lame seghetto
12 pz / confezione

75 x 3 x 0,25 mm
6301-1

75 x 5 x 0,25 mm
6301-2

75 x 3 x 0,12 mm
6301-3

lunghezza x altezza x spessore

“Lab Set” per odontotecnica

astuccio per modellazione cera/porcellana



S6811-2

	strumento per modellare Hylin	5100
	strumento per modellare Hylin-Le Cron	5101
	strumento per modellare Hylin	5105
	strumento per modellare Zahle	5111
1	strumento per modellare P.K. Thomas	5112-1
2	strumento per modellare P.K. Thomas	5112-2
3	strumento per modellare P.K. Thomas	5112-3
4	strumento per modellare P.K. Thomas	5112-4
5	strumento per modellare P.K. Thomas	5112-5
	strumento per modellare Gritman	5113
1	strumento per cera	S5160-1C
2	strumento per cera	S5160-2C
3	strumento per cera	S5160-3C
1	coltello per cera Fahrenstock	5200-1
2	coltello per cera Fahrenstock	5200-2
	calibro	2555

astuccio vuoto per 17 strumenti



8000

“Lab Set” per odontotecnica

valigetta per odontotecnica



S6810-1

valigetta per odontotecnica



S6810-2

2	pinzetta per laboratorio	6400-2
	cesoia taglia gesso	5900
	seghetto per modelli	6300
	tazza - ø 120 mm	5500-12
2	forbicina per corone	5600-2
6	spatola per alginato e gesso	5400-6
2	coltello per gessi Gritman	5300-2
1	coltello per gessi Fahrenstock	5200-1
2	coltello per gessi Fahrenstock	5200-2
	pinza per piegare fili	5801-1
	calibro Iwanson	2550-2
	martello	6001
	strumento per modellare Hylin	5100
	strumento per modellare Hylin-Le Cron	5101
	strumento per modellare Hylin-Ceramica	5102
	strumento per modellare Hylin	5105
	strumento per modellare Le Cron	5106
	strumento per modellare Zahle	5109
	strumento per modellare Gritman	5113
	strumento per modellare Beale	5114
1	strumento per modellare P.K. Thomas	5112-1
2	strumento per modellare P.K. Thomas	5112-2
3	strumento per modellare P.K. Thomas	5112-3
4	strumento per modellare P.K. Thomas	5112-4
5	strumento per modellare P.K. Thomas	5112-5
2	pinzetta per laboratorio	6400-2
	cesoia taglia gesso	5900
	seghetto per modelli	6300
	tazza - ø 120 mm	5500-12
2	forbicina per corone	5600-2
6	spatola per alginato e gesso	5400-6
2	coltello per gessi Gritman	5300-2
1	coltello per gessi Fahrenstock	5200-1
2	coltello per gessi Fahrenstock	5200-2
	calibro Iwanson	2550-2
	set per ceramica e resine di rivestimento	5150
	strumento per modellare Hylin-Le Cron	5101
	strumento per modellare Le Cron	5106
	strumento per modellare Zahle	5109
	strumento per modellare Gritman	5113
	strumento per modellare Beale	5114
1	strumento per modellare P.K. Thomas	5112-1
2	strumento per modellare P.K. Thomas	5112-2
3	strumento per modellare P.K. Thomas	5112-3
4	strumento per modellare P.K. Thomas	5112-4
5	strumento per modellare P.K. Thomas	5112-5

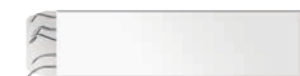

il set di strumenti per modellare, S5112, è inserito nelle valigette S6810-1 e S6810-2 all'interno di una confezione in cartoncino bianco come da immagine

INDICE DEI CODICI

codice	descrizione	manico	pagina
0100-1	Pinze per estrazione		D4
0100-2	Pinze per estrazione		D4
0100-3	Pinze per estrazione		D4
0100-4	Pinze per estrazione		D4
0100-7	Pinze per estrazione		D4
0100-8	Pinze per estrazione		D4
0100-13	Pinze per estrazione		D5
0100-17	Pinze per estrazione		D5
0100-18	Pinze per estrazione		D5
0100-18A	Pinze per estrazione		D5
0100-19	Pinze per estrazione		D6
0100-20	Pinze per estrazione		D5
0100-21	Pinze per estrazione		D5
0100-22	Pinze per estrazione		D6
0100-22L	Pinze per estrazione · Routurier		D6
0100-22R	Pinze per estrazione · Routurier		D7
0100-23	Pinze per estrazione		D7
0100-24	Pinze per estrazione		D7
0100-29	Pinze per estrazione		D7
0100-29N	Pinze per estrazione		D7
0100-30	Pinze per estrazione		D8
0100-31	Pinze per estrazione		D8
0100-33	Pinze per estrazione		D8
0100-33A	Pinze per estrazione		D8
0100-33L	Pinze per estrazione		D8
0100-38A	Pinze per estrazione		D8
0100-41	Pinze per estrazione		D8
0100-43A	Pinze per estrazione		D9
0100-44	Pinze per estrazione		D9
0100-45	Pinze per estrazione		D9
0100-46	Pinze per estrazione		D9
0100-46L	Pinze per estrazione		D9
0100-48	Pinze per estrazione		D10
0100-49	Pinze per estrazione		D10
0100-51	Pinze per estrazione		D10
0100-51A	Pinze per estrazione		D10
0100-51L	Pinze per estrazione		D10
0100-51LX	Pinze per estrazione		D11
0100-52	Pinze per estrazione		D11
0100-54	Pinze per estrazione		D11
0100-55	Pinze per estrazione		D11
0100-56	Pinze per estrazione		D11
0100-59	Pinze per estrazione		D11
0100-59L	Pinze per estrazione		D11
0100-60	Pinze per estrazione		D12
0100-65L	Pinze per estrazione		D12
0100-65R	Pinze per estrazione		D12
0100-66L	Pinze per estrazione		D12
0100-66R	Pinze per estrazione		D13
0100-67	Pinze per estrazione		D13
0100-67/L	Pinze per estrazione		D13
0100-67/R	Pinze per estrazione		D13
0100-67A	Pinze per estrazione		D13
0100-68	Pinze per estrazione		D14

code	description	handle	page
0100-73	Pinze per estrazione		D14
0100-74	Pinze per estrazione		D14
0100-74M	Pinze per estrazione		D14
0100-74N	Pinze per estrazione		D14
0100-75	Pinze per estrazione		D15
0100-79	Pinze per estrazione		D15
0100-79A	Pinze per estrazione		D15
0100-79C	Pinze per estrazione		D15
0100-86/L	Pinze per estrazione · Routurier		D16
0100-86/R	Pinze per estrazione · Routurier		D16
0100-86C	Pinze per estrazione		D16
0100-86W	Pinze per estrazione · White		D17
0100-87	Pinze per estrazione		D17
0100-89	Pinze per estrazione		D18
0100-90	Pinze per estrazione		D18
0100-99	Pinze per estrazione		D18
0100-107	Pinze per estrazione		D19
0100-121	Pinze per estrazione · Ogden-Felsch		D19
0100-145	Pinze per estrazione		D19
0100-151/	Pinze per estrazione		D19
0100-166	Pinze per estrazione · Trotter		D17
0100-167	Pinze per estrazione · Trotter		D20
0100-168	Pinze per estrazione · Trotter		D19
0100-169	Pinze per estrazione · Trotter		D20
0100-346	Pinze per estrazione		D19
0100-349	Pinze per estrazione		D20
0100-359	Pinze per estrazione		D20
0101-1	Pinze per radici e frammenti · Witzel		D40
0101-2	Pinze per radici e frammenti · Witzel		D40
0102-1	Pinze per radici e frammenti e coni d'argento · Stieglitz		B16
0102-2	Pinze per radici e frammenti e coni d'argento · Stieglitz		B16
0103-10	Pinze ossivore alveolotome · Luer		D42
0103-20	Pinze ossivore alveolotome · Friedman		D42
0103-25	Pinze ossivore alveolotome · Mini Friedman		D42
0103-30	Pinze ossivore alveolotome · Blumenthal		D43
0103-31	Pinze ossivore alveolotome · Blumenthal		E30
0103-32	Pinze ossivore alveolotome · Blumenthal		E30
0103-40	Pinze ossivore alveolotome · Cleveland		D43
0103-45	Pinze ossivore alveolotome · Cleveland-Gardner		D42
0103-50	Pinze ossivore alveolotome · Mead		D43

codice	descrizione	manico	pagina
0103-60	Pinze per tessuti · Goldman-Fox		D44
			E29
			G30
0103-70	Pinze ossivore alveolotome · Mini-Ruskin		D44
0103-71	Pinze ossivore alveolotome · Beyer		D44
0103-78	Ulocistotomi · Tomati		G30
0104-1	Pinze per estrazione · Mead		D24
0104-2	Pinze per estrazione · Mead		D24
0104-3	Pinze per estrazione · Mead		D24
0104-4	Pinze per estrazione · Mead		D24
0110-13S	Pinze per estrazione per bambini		D37
0110-22S	Pinze per estrazione per bambini		D37
0110-30S	Pinze per estrazione per bambini		D37
0110-33S	Pinze per estrazione per bambini		D37
0110-37	Pinze per estrazione per bambini		D37
0110-38	Pinze per estrazione per bambini		D38
0110-39	Pinze per estrazione per bambini		D38
0110-39L	Pinze per estrazione per bambini		D38
0110-39R	Pinze per estrazione per bambini		D38
0110-51S	Pinze per estrazione per bambini		D38
0112-1	Pinze per estrazione per bambini · Klein		D39
0112-2	Pinze per estrazione per bambini · Klein		D39
0112-3	Pinze per estrazione per bambini · Klein		D39
0112-4	Pinze per estrazione per bambini · Klein		D39
0112-5	Pinze per estrazione per bambini · Klein		D39
0112-6	Pinze per estrazione per bambini · Klein		D39
0112-7	Pinze per estrazione per bambini · Klein		D39
0120-5	Pinze per estrazione forma americana · Physick		D25
0120-6	Pinze per estrazione forma americana		D25
0120-10S	Pinze per estrazione forma americana		D25
0120-16	Pinze per estrazione forma americana		D25
0120-17	Pinze per estrazione forma americana		D25
0120-18L	Pinze per estrazione forma americana · Harris		D26
0120-18R	Pinze per estrazione forma americana · Harris		D26
0120-23	Pinze per estrazione forma americana		D26
0120-53L	Pinze per estrazione forma americana		D26
0120-53R	Pinze per estrazione forma americana		D26
0120-65	Pinze per estrazione forma americana		D27
0120-69	Pinze per estrazione forma americana · Tomes		D27
0120-88L	Pinze per estrazione forma americana · Nevius		D27
0120-88R	Pinze per estrazione forma americana · Nevius		D27

codice	descrizione	manico	pagina
0120-101	Pinze per estrazione forma americana · Hull		D27
0120-150	Pinze per estrazione forma americana · Cryer		D28
0120-150S	Pinze per estrazione forma americana · Cryer		D28
0120-151	Pinze per estrazione forma americana · Cryer		D28
0120-151S	Pinze per estrazione forma americana · Cryer		D28
0120-222	Pinze per estrazione forma americana		D28
0130-1	Pinze per estrazione · manico anatomico		D33
0130-2	Pinze per estrazione · manico anatomico		D33
0130-4	Pinze per estrazione · manico anatomico		D33
0130-7	Pinze per estrazione · manico anatomico		D33
0130-13	Pinze per estrazione · manico anatomico		D33
0130-17	Pinze per estrazione · manico anatomico		D34
0130-18	Pinze per estrazione · manico anatomico		D34
0130-21	Pinze per estrazione · manico anatomico		D34
0130-22	Pinze per estrazione · manico anatomico		D34
0130-33	Pinze per estrazione · manico anatomico		D34
0130-45	Pinze per estrazione · manico anatomico		D34
0130-51A	Pinze per estrazione · manico anatomico		D34
0130-67A	Pinze per estrazione · manico anatomico		D35
0130-74	Pinze per estrazione · manico anatomico		D35
0130-79	Pinze per estrazione · manico anatomico		D35
0130-86C	Pinze per estrazione · manico anatomico		D35
0130-89	Pinze per estrazione · manico anatomico		D36
0130-90	Pinze per estrazione · manico anatomico		D36
0130-145	Pinze per estrazione · manico anatomico		D36
0130-151/	Pinze per estrazione · manico anatomico		D36
0130-349	Pinze per estrazione · manico anatomico		D36
0130-359	Pinze per estrazione · manico anatomico		D36
0200-1	Leve per radici · Bein		D47
0200-2	Leve per radici · Bein		D47
0200-3	Leve per radici · Bein		D47
0200-4	Leve per radici · Bein		D47
0200-5	Leve per radici · Bein		D47
0200-6	Leve per radici · Bein		D47
0201-1	Leve per radici · Flohr		D49
0201-2	Leve per radici · Flohr		D49

codice	descrizione	manico	pagina	codice	descrizione	manico	pagina	codice	descrizione	manico	pagina	codice	descrizione	manico	pagina	
0201-3	Leve per radici · Flohr		D49	0220-25	Leve per radici · Cryer		D55	0259-4L	Leve per radici · Seldin		D60	0301-2	Forbicine per gengive · angolari, una punta dentata		C3	
0202-320	Leve per radici · Walter F. Barry		D61	0220-26	Leve per radici · Cryer		D55	0259-4R	Leve per radici · Seldin		D60	0302-1	Forbicine per gengive · curve · Neumann		C7	
0202-321	Leve per radici · Walter F. Barry		D61	0220-31	Leve per radici · Cryer		D55	0265-301	Leve per radici · Apexo		D60	0303-1	Forbicine per gengive · punte curve e sottili · Noyes (Castroviejo)		C7	
0202-322	Leve per radici · Walter F. Barry		D61	0220-32	Leve per radici · Cryer		D55	0266-01W	Leve per radici · Seldin		D60	0304-1	Forbicine per gengive · rette, una punta dentata · Goldman-Fox		C3	
0202-323	Leve per radici · Walter F. Barry		D61	0220-44	Leve per radici · Cryer		D55	0267-1	Leve per radici · Heidbrink		D60	E4	0304-1TC	Forbicine per gengive · rette · Goldman-Fox		C4
0202-350	Leve per radici · Walter F. Barry		D61	0220-45	Leve per radici · Cryer		D55	0267-2	Leve per radici · Heidbrink		D60	0304-2	Forbicine per gengive · curve, una punta dentata · Goldman-Fox		C3	
0202-351	Leve per radici · Walter F. Barry		D61	0221-A1C	Leve per radici · Coupland		D56	0267-41	Leve per radici · Heidbrink		D60	E4	0304-2TC	Forbicine per gengive · curve · Goldman-Fox		C4
0202-370	Leve per radici · Walter F. Barry		D61	0221-A2C	Leve per radici · Coupland		D56	0270-25	Leve per radici · Cryer		D60	0304-3	Forbicine per gengive · curve, una punta dentata · Goldman-Fox (specia)		C4	
0202-371	Leve per radici · Walter F. Barry		D61	0221-A3C	Leve per radici · Coupland		D56	0270-26	Leve per radici · Cryer		D60	0305-1	Forbicine per gengive · rette · Iris		C4	
0203-1	Leve per radici · Lecluse		D63	0222-190	Leve per radici		D56	0270-44	Leve per radici · Cryer		D60	0305-1TC	Forbicine per gengive · rette · Iris		C4	
0203-24	Leve per radici · Pott		D63	0222-191	Leve per radici		D56	0270-45	Leve per radici · Cryer		D60	0305-2	Forbicine per gengive · curve · Iris		C4	
0203-25	Leve per radici · Pott		D63	0223-15	Leve per radici · Woodward		D56	0290-1	Mini-leve per frammenti di radici · Heidbrink		D64	0305-2TC	Forbicine per gengive · rette · Iris		C4	
0204-11L	Leve per radici · Winter		D62	0223-16	Leve per radici · Woodward		D56	0290-2	Mini-leve per frammenti di radici · Heidbrink		D64	0305-3	Forbicine per gengive · curve · Iris		C5	
0204-11R	Leve per radici · Winter		D62	0228-31F	Leve per radici · Friedman		D57	0290-3	Mini-leve per frammenti di radici · Heidbrink		D64	0306-1	Forbicine per gengive · curve, una punta dentata · Dean		C7	
0204-12L	Leve per radici · Winter		D62	0228-32F	Leve per radici · Friedman		D57	0291-1	Leve per radici · Heidbrink		D49	0306-1TC	Forbicine per gengive · curve · Goldman-Fox		C4	
0204-12R	Leve per radici · Winter		D62	0229-1C	Leve per radici · Coupland		D58	0291-1F	Leve per radici · Mini Friedman		D57	0307-1	Forbicine per gengive · curve, una punta dentata · La Grange		C7	
0204-14L	Leve per radici · Winter		D62	0229-1F	Leve per radici · Friedman		D57	0291-2	Leve per radici · Heidbrink		D49	0308-1	Forbicine per gengive · rette · Quinby		C5	
0204-14R	Leve per radici · Winter		D62	0229-2C	Leve per radici · Coupland		D58	0291-2F	Leve per radici · Mini Friedman		D57	0308-2	Forbicine per gengive · curve · Quinby		C5	
0204-1L	Leve per radici · Winter		D62	0229-2F	Leve per radici · Friedman		D57	0291-3	Leve per radici · Heidbrink		D49	0309-1	Forbicine per gengive · rette · Kelly		C5	
0204-1R	Leve per radici · Winter		D62	0229-3C	Leve per radici · Coupland		D58	0294-1	Mini-leve per frammenti di radici · Warwick-James		D64	0309-1TC	Forbicine per gengive · rette · Kelly		C5	
0205-4	Leve per radici · Schmeckebier-Apexo		D49	0230-11M	Leve per radici · Mac Millan		D56	0294-2	Mini-leve per frammenti di radici · Warwick-James		D64	E4	0309-2	Forbicine per gengive · curve · Kelly		C5
0205-4B	Leve per radici · Schmeckebier-Apexo		D49	0230-12M	Leve per radici · Mac Millan		D56	0294-3	Mini-leve per frammenti di radici · Warwick-James		D64	0309-2TC	Forbicine per gengive · curve · Kelly		C5	
0205-5	Leve per radici · Schmeckebier-Apexo		D49	0230-13M	Leve per radici · Mac Millan		D56	0295-1	Sindesmotomi · Chompret		D65	0310-1	Forbicine per gengive · angolari, una punta dentata · Locklin		C6	
0205-5B	Leve per radici · Schmeckebier-Apexo		D49	0231-2	Leve per radici · London Hospital		D46	0295-2	Sindesmotomi · Chompret		D65	0310-1TC	Forbicine per gengive · angolari · Locklin		C6	
0206-71	Leve per radici · Miller-Apexo		D52	0231-3	Leve per radici · London Hospital		D46	0295-3	Sindesmotomi · Chompret		D65	0310-2	Forbicine per gengive · angolari, una punta dentata · Locklin		C6	
0206-72	Leve per radici · Miller-Apexo		D52	0232-1	Leve per radici · Coleman		D46	0295-4	Sindesmotomi · Chompret		D65	0310-2TC	Forbicine per gengive · angolari · Locklin		C6	
0206-73	Leve per radici · Miller-Apexo		D52	0233-2	Leve per radici		D46	0296-0	Sindesmotomi · punta		D66	0311-1	Forbicine per gengive · rette, una punta dentata · Sullivan		C6	
0206-74	Leve per radici · Miller-Apexo		D52	0234-1	Leve per radici · Hylin		D45	0296-1	Sindesmotomi · punta		D66	0311-2	Forbicine per gengive · curve, una punta dentata · Sullivan		C6	
0207-19	Leve per radici		D52	0234-2	Leve per radici · Hylin		D45	0296-2	Sindesmotomi · punta		D66	0312-1	Forbicine per gengive · curve, punte acute · Westcott		C7	
0207-20	Leve per radici		D52	0234-3	Leve per radici · Hylin		D45	0296-3	Sindesmotomi · punta		D66	0312-2	Forbicine per gengive · curve, punte arrotondate · Westcott		C7	
0208-2S	Leve per radici · Seldin		D52	0234-4	Leve per radici · Hylin		D45	0296-4	Sindesmotomi · punta		D66	0313-1	Forbicine per gengive · curve, punte molto sottili		C7	
0208-3S	Leve per radici · Seldin		D52	0240-1	Leve per radici · Bein		D48	0296-5	Sindesmotomi · punta		D66	0320-1	Forbicine per gengive per sutura · Spencer		C8	
0208-34	Leve per radici · Bein		D52	0240-2	Leve per radici · Bein		D48	0296-6	Sindesmotomi · punta		D66	0320-2	Forbicine per gengive per sutura · Spencer		C8	
0208-34S	Leve per radici · Seldin		D52	0240-3	Leve per radici · Bein		D48	0296-7	Sindesmotomi · punta		D66	0321-1	Forbicine per gengive per separazioni · rette · Metzenbaum		C8	
0209-1L	Leve per radici · Seldin		D53	0240-4	Leve per radici · Bein		D48	0296-8	Sindesmotomi · punta		D66	0321-2	Forbicine per gengive per separazioni · curve · Metzenbaum		C8	
0209-1R	Leve per radici · Seldin		D53	0240-5	Leve per radici · Bein		D48	0296-9	Sindesmotomi · punta		D66					
0209-4L	Leve per radici · Seldin		D53	0240-6	Leve per radici · Bein		D48	0296-11	Sindesmotomi · punta		D66					
0209-4R	Leve per radici · Seldin		D53	0241-2	Leve per radici · Flohr		D58	0296-21	Sindesmotomi · punta		D66					
0210-51	Leve per radici · Curtis		D53	0241-3	Leve per radici · Flohr		D58	0296-22	Sindesmotomi · punta		D67					
0210-52	Leve per radici · Curtis		D53	0242-1	Leve per radici		D58	0296-23	Sindesmotomi · punta		D67					
0211-11	Leve per radici · Stout		D53	0242-2	Leve per radici		D58	0296-24	Sindesmotomi · punta		D67					
0211-11A	Leve per radici · Stout		D53	0243-7	Leve per radici · Cryer		D55	0296-25	Sindesmotomi · punta		D67					
0213-12	Leve per radici		D53	0243-8	Leve per radici · Cryer		D55	0296-26	Sindesmotomi · punta		D67					
0214-A	Leve per radici · Cogswell		D54	0244-1	Leve per radici · Kopp		D50	0296-27	Sindesmotomi · punta		D67					
0215-301	Leve per radici · Apexo		D54	0244-2	Leve per radici · Kopp		D50	0296-28	Sindesmotomi · punta		D67					
0215-302	Leve per radici · Apexo		D54	0244-3	Leve per radici · Kopp		D50	0296-29	Sindesmotomi · punta		D67					
0215-303	Leve per radici · Apexo		D54	0244-4	Leve per radici · Kopp		D50	0296-M	Sindesmotomi · manico		D66					
0216-01W	Leve per radici · Seldin		D54	0244-5	Leve per radici · Kopp		D50	0297-1	Kit di Sindesmotomi		D69					
0216-04W	Leve per radici · Seldin		D54	0244-6	Leve per radici · Kopp		D50	0300-1	Forbicine per gengive · rette		C3					
0217-1	Leve per radici · Heidbrink		D54	0250-1	Leve per radici · Bein		D59	F45								
0217-2	Leve per radici · Heidbrink		D54	0250-2	Leve per radici · Bein		D59	K28								
0217-40	Leve per radici · Heidbrink		D54	0250-3	Leve per radici · Bein		D59	C3								
0217-41	Leve per radici · Heidbrink		D54	0250-4	Leve per radici · Bein		D59	K28								
0218-1	Leve per radici		D51	0250-5	Leve per radici · Bein		D59	C3								
0218-2	Leve per radici		D51	0250-6	Leve per radici · Bein		D59	K28								
0218-3	Leve per radici		D51	0251-1	Leve per radici · Flohr		D59	C3								
0218-4	Leve per radici		D51	0251-2	Leve per radici · Flohr		D59	C3								
0218-81A	Leve per radici		D56	0251-3	Leve per radici · Flohr		D59	C3								
0219-1	Leve per radici		D51	0255-4	Leve per radici · Schmeckebier-Apexo		D59	C3								
0219-2	Leve per radici		D51	0255-5	Leve per radici · Schmeckebier-Apexo		D59	C3								
				0256-71	Leve per radici · Miller-Apexo		D60									
				0256-72	Leve per radici · Miller-Apexo		D60									

codice	descrizione	manico	pagina	codice	descrizione	manico	pagina	codice	descrizione	manico	pagina	codice	descrizione	manico	pagina
0322-1	Forbicine per gengive per separazioni · rette · Metzbaum-Delikat		C8 E4	0371-10	Bisturi monouso		C25 E10	0444-12L	Porta aghi · punte lisce · Castroviejo-Barraquer		C19 C18	0494-2	Raschietti per osso · curvo		E28
0322-2	Forbicine per gengive per separazioni · curve · Metzbaum-Delikat		C8 E4	0371-11	Bisturi monouso		C25 E10	0445-14TC	Porta aghi · Castroviejo		C18 E5	0494-2R	Raschietti per osso · retto		E28
0325-1	Forbicine per gengive per sutura · rette · Mayo		C8	0371-12	Bisturi monouso		C25 E10	0445-18TC	Porta aghi · Castroviejo		C19	0495-1	Osteotomi		E19
0325-2	Forbicine per gengive per sutura · curve · Mayo		C8	0371-15	Bisturi monouso		C25 E10	0446-14TC	Porta aghi · Castroviejo		C18 E5	0495-2	Osteotomi		E19
0328-1	Forbicine per gengive per separazioni · rette · Stevens		C9	0400-14	Porta aghi · con forbice · Olsen-Hegar		C10	0446-18TC	Porta aghi · Castroviejo		C19	0495-3	Osteotomi		E19
0328-2	Forbicine per gengive per separazioni · curve · Stevens		C9	0401-12	Porta aghi · Derf		C13	0447-13TC	Porta aghi · Castroviejo		C19	0495-4	Osteotomi		E19
0329-1	Forbicine per gengive per separazioni · punte stondate rette · Stevens		C9	0403-17	Porta aghi · Adson		C10	0448-14TC	Porta aghi · Castroviejo		C18 E5	0495-5	Osteotomi		E19
0329-2	Forbicine per gengive per separazioni · punte stondate, curve · Stevens		C9	0404-14	Porta aghi · Baumgartner		C11	0450-18TC	Porta aghi · Micro-Barraquer		C17 E6	0495-6	Osteotomi		E19
0330-1	Forbicine per gengive per separazioni · rette · Stevens		C9	0405-14TC	Porta aghi · Olsen-Hegar		C10	0451-18TC	Porta aghi · punte curve · Micro-Barraquer		C17 E6	0496-1P	Osteotomi		E20
0330-2	Forbicine per gengive per separazioni · curve · Stevens		C9	0406-12TC	Porta aghi · Derf		C13	0480-1	Siringhe · puntale a cavatappi, filettatura metrico decimale		C29	0496-2P	Osteotomi		E20
0335-1	Manici per bisturi · lama orientabile		C24 E9	0407-13TC	Porta aghi · punte lisce · Halsey-Smooth		C13	0480-2	Siringhe · puntale a cavatappi, filettatura metrico decimale		C29	0496-3P	Osteotomi		E20
0350-3	Manici per bisturi · a doppio taglio		C26 E7	0408-13TC	Porta aghi · Halsey		C13	0480-3	Siringhe · puntale a cavatappi, filettatura metrico decimale		C29	0496-4P	Osteotomi		E20
0350-3G	Manici per bisturi		C26 E7	0409-14TC	Porta aghi · Hegar-Baumgartner		C11	0480-4	Siringhe · puntale a cavatappi, filettatura metrico decimale		C29	0497-1T	Osteotomi		E20
0350-5	Manici per bisturi		C26 E8	0410-15	Porta aghi · Crile-Wood		C10	0480-4W	Siringhe · puntale a cavatappi, filettatura imperiale (Whitworth)		C29	0497-2T	Osteotomi		E20
0350-5A	Manici per bisturi		C26 E8	0414-16	Porta aghi · con forbice · Gillies		C14	0480-5	Siringhe · autoaspirante, filettatura metrico decimale		C28	0497-3T	Osteotomi		E20
0350-7	Manici per bisturi		C26 E7	0415-15TC	Porta aghi · Mini-Ryder		C13	0480-6	Siringhe · autoaspirante, filettatura metrico decimale		C28	0498-1B3	Osteotomi		E18
0350-8	Manici per bisturi		C26 E7	0416-15TC	Porta aghi · Mini-Ryder		C13	0480-P1	Siringhe · puntale di ricambio, filettatura metrico decimale		C29	0498-1B33	Osteotomi		E18
0351-10	Lame per bisturi		C26 E8	0416-18TC	Porta aghi · Mini-Ryder		C13	0480-P2	Siringhe · puntale di ricambio, filettatura imperiale (Whitworth)		C29	0498-1B4	Osteotomi		E18
0351-11	Lame per bisturi		C26 E8	0417-15TC	Porta aghi · Fine Swedish		C14	0481-7	Siringhe · intraligamentale, filettatura metrico decimale		C30	0498-1B5	Osteotomi		E18
0351-12	Lame per bisturi		C26 E8	0418-15TC	Porta aghi · Micro-Vascular		C14	0481-8	Siringhe · intraligamentale, filettatura metrico decimale		C30	0498-2C3	Osteotomi		E18
0351-12D	Lame per bisturi · a doppio taglio		C26 E8	0419-16TC	Porta aghi · con forbice · Gillies		C14	0481-T1	Siringhe · protezione in plastica autoclavabile		C30	0498-2C33	Osteotomi		E18
0351-15	Lame per bisturi		C26 E8	0420-16	Porta aghi · Mayo-Hegar		C12	0482-1	Siringhe · base di appoggio per siringhe		C30	0498-2C4	Osteotomi		E18
0351-15C	Lame per bisturi		C26 E8	0420-18	Porta aghi · Mayo-Hegar		C12	0482-3W	Siringhe · non autoaspirante, filettatura imperiale (Whitworth)		C28	0498-2C5	Osteotomi		E18
0352	Pinze togli lama		C24 E9	0421-18	Porta aghi · modello leggero · Toennis		C14	0482-4W	Siringhe · non autoaspirante, filettatura imperiale (Whitworth)		C28	0498-30B3	Osteotomi		E18
0360-4	Manici per bisturi		C27	0422-19	Porta aghi · Eiselberg-Mathieu		C15	0482-6W	Siringhe · autoaspirante, filettatura imperiale (Whitworth)		C28	0498-30B33	Osteotomi		E18
0361-20	Lame per bisturi		C27	0425-16TC	Porta aghi · Mayo-Hegar		C12	0482-7W	Siringhe · intraligamentale, filettatura imperiale (Whitworth)		C30	0498-30B4	Osteotomi		E18
0361-21	Lame per bisturi		C27	0425-18TC	Porta aghi · Mayo-Hegar		C12	0483-1	Siringhe · autoaspirante, filettatura metrico decimale		C28	0498-30B5	Osteotomi		E18
0361-22	Lame per bisturi		C27	0426-18TC	Porta aghi · modello leggero · Toennis		C14	0483-2	Siringhe · non autoaspirante, filettatura metrico decimale		C28	0498-PF3	Osteotomi		E18
0361-23	Lame per bisturi		C27	0430-14	Porta aghi · Mathieu		C16	0483-3	Siringhe · non autoaspirante, filettatura metrico decimale		C28	0498-PF33	Osteotomi		E18
0361-24	Lame per bisturi		C27	0430-17	Porta aghi · Mathieu		C16	0490-1	Iniettori per osso		E27	0498-PF4	Osteotomi		E18
0365-1	Micro lame		C27 E9	0431-14	Porta aghi · Mathieu		C16	0490-2	Iniettori per osso		E27	0498-PF5	Osteotomi		E18
0366-4	Micro lame		C27 E9	0431-17	Porta aghi · Mathieu		C16	0491-1	Spessimetri per osso		E31	0500-1	Pinze emostatiche · rette · Halstead-Mosquito		C21 F44
0366-7	Micro lame		C27 E9	0432-14	Porta aghi · con forbice · Mathieu		C16	0491-2	Spessimetri per osso		E31	0500-2	Pinze emostatiche · curve · Halstead-Mosquito		C21
				0432-14TC	Porta aghi · Mathieu		C16	0493-1	Cannule per aspirazione		E33	0501-1	Pinze emostatiche · rette · Micro-Mosquito		C22 F44
				0432-17	Porta aghi · movimento leggero · Lichtenberg		C15	0493-2	Filtri per cannule aspirazione		E33	0501-2	Pinze emostatiche · curve · Micro-Mosquito		C22
				0433-16	Porta aghi · Arruga		C15	0493-5	Cannule per aspirazione		E33	0505-1	Pinze emostatiche · rette · Halstead-Mosquito 1x2		C21
				0435-14TC	Porta aghi · Mathieu		C17 E5	0494-1	Raschietti per osso · retto		E28	0505-2	Pinze emostatiche · curve · Halstead-Mosquito 1x2		C21
				0435-17TC	Porta aghi · Mathieu		C17 E5	0494-1R	Raschietti per osso · retto		E28	0506-1	Pinze emostatiche · rette · Micro-Mosquito 1x2		C22
				0436-14TC	Porta aghi · Mathieu		C17					0506-2	Pinze emostatiche · curve · Micro-Mosquito 1x2		C22
				0436-17TC	Porta aghi · Mathieu		C17 C15					0507-1	Pinzette per elastici · rette · Halstead-Mosquito		H36
				0437-17TC	Porta aghi · Lichtenberg		C15 E5					0507-2	Pinzette per elastici · curve · Halstead-Mosquito		H36
				0438-16TC	Porta aghi · Arruga		C15					0510-1	Pinze emostatiche · rette · Kelly		C23 F44
				0440-14	Porta aghi · Castroviejo		C18					0510-2	Pinze emostatiche · curve · Kelly		C23
				0440-18	Porta aghi · Castroviejo		C19					0515-1	Pinze emostatiche · rette · Hartmann		C23
				0441-14	Porta aghi · punte curve · Castroviejo		C18					0515-2	Pinze emostatiche · curve · Hartmann		C23
				0441-18	Porta aghi · punte curve · Castroviejo		C19					0520-1	Pinze emostatiche · rette · Crile		C20
				0442-13	Porta aghi · Castroviejo		C19					0520-2	Pinze emostatiche · curve · Crile		C20
				0442-13L	Porta aghi · punte lisce · Castroviejo		C19					0530-1	Pinze emostatiche · rette · Kocher 1x2		C20
				0443-14	Porta aghi · Castroviejo		C18					0530-2	Pinze emostatiche · curve · Kocher 1x2		C20
												0540-1	Pinze emostatiche · rette · Pean		C20
												0540-2	Pinze emostatiche · curve · Pean		C20

codice	descrizione	manico	pagina
0545-1	Strumenti per corone		K29
0550-1	Pinze per pannolino · Backhaus		C31
0550-2	Pinze per pannolino · Backhaus		C31
0550-3	Pinze per pannolino · Backhaus		C31
0555-1	Pinze porta tamponi · rette · Gross-Maier		C32
0555-2	Pinze porta tamponi · curve · Gross-Maier		C32
0557-1	Pinze porta tamponi · rette · Gross-Maier		C32
0557-2	Pinze porta tamponi · curve · Gross-Maier		C32
0561-R	Pinze tiralingua		C33
0565-1	Pinze per sterilizzazione		I13
0565-2	Pinze per sterilizzazione		I13
0560	Pinze tiralingua · Coltin		C33
0561	Pinze tiralingua · Young		C33
0600-17	Pinzette per medicazioni		B5
0600-18	Pinzette per medicazioni		B5
0600-18L	Pinzette per medicazioni · Locking		B3
0600-19	Pinzette per medicazioni		B5
0600-2	Pinzette per medicazioni · London-College		B4
0600-3	Pinzette per medicazioni		B5
0600-4	Pinzette per medicazioni · Perry		B4
0601-1	Pinzette per medicazioni · Flagg		B4
0601-2	Pinzette per medicazioni · London-College		B4
0601-3	Pinzette per medicazioni · Meriam		B4
0601-4	Pinzette per medicazioni · Perry		B4
0601-5	Pinzette per medicazioni · Perry		B4
0602-1	Pinzette per medicazioni		B3
0602-2	Pinzette per medicazioni		B3
0620-1	Pinzette chirurgiche · Adson		C38
0621-1	Pinzette chirurgiche · Adson 1x2		E36
0622-1	Pinzette chirurgiche · Micro-Adson 1x2		C38
0622-2	Pinzette chirurgiche · Micro-Adson 1x2		C39
0623-1	Pinzette chirurgiche		C39
0624-1	Pinzette chirurgiche · Micro-Adson		C39
0624-2	Pinzette chirurgiche · Micro-Adson		C39
0625-1	Pinzette per sutura		C40
0626-1	Pinzette chirurgiche · atraumatiche · Adson Brown		C41
0630-1	Pinzette chirurgiche · Semken-Taylor		C41
0630-2	Pinzette chirurgiche · Semken-Taylor		C41
0631-1	Pinzette chirurgiche · Semken-Taylor 1x2		C41
0631-2	Pinzette chirurgiche · Semken-Taylor 1x2		C41
0635-1	Pinzette chirurgiche		C43
0635-2	Pinzette chirurgiche		C43
0635-3	Pinzette chirurgiche		C43
0635-4	Pinzette chirurgiche		C43
0635-5	Pinzette chirurgiche		C43
0635-6	Pinzette per laboratorio		K19

codice	descrizione	manico	pagina
0645-1	Pinzette chirurgiche		C42
0645-2	Pinzette chirurgiche		C42
0645-3	Pinzette chirurgiche		C42
0645-4	Pinzette chirurgiche		C42
0645-5	Pinzette chirurgiche		C42
0650-1	Pinzette per marcare le tasche · Goldman-Fox (Crane-Kaplan)		B3
0650-2	Pinzette per marcare le tasche · Goldman-Fox (Crane-Kaplan)		B3
0660-1	Pinzette per membrana		E37
0660-2	Pinzette per membrana · con punte ad anello		E37
0661-1	Pinzette porta impianti		E37
0661-2	Pinzette porta impianti		E37
0661-3	Pinzette porta impianti		E37
0670	Pinzette per carta da articolazione · Miller		F42
0671	Pinzette per carta da articolazione		F42
0680	Pinze per pannolino · Schaedle		C31
0681	Pinze per pannolino · Jones		C31
0690	Specchietti ultralight		B21
0690-G	Specchietti ultralight		B21
0690-L	Specchietti ultralight		B21
0690-M	Specchietti ultralight		B21
0690-T	Specchietti ultralight		B21
0691	Divaricatori ultralight		B21
0700-10	Sonde singole	Asa60	B6
0700-11	Sonde singole	Asa60	B6
0700-12	Sonde singole	Asa60	B6
0700-16	Sonde singole	Asa60	B6
0700-17	Sonde singole	Asa60	B6
0700-17A	Sonde singole	Asa60	B6
0700-2	Sonde singole	Asa60	B6
0700-23	Sonde singole	Asa60	B6
0700-3	Sonde singole	Asa60	B6
0700-3A	Sonde singole	Asa60	B6
0700-3R	Sonde singole · Rhein	Asa60	B6
0700-5	Sonde singole	Asa60	B6
0700-6	Sonde singole	Asa60	B6
0700-8	Sonde singole	Asa60	B6
0700-9	Sonde singole	Asa60	B6
0701-10	Sonde singole	Asa60M	B6
0701-11	Sonde singole	Asa60M	B6
0701-12	Sonde singole	Asa60M	B6
0701-16	Sonde singole	Asa60M	B6
0701-17	Sonde singole	Asa60M	B6
0701-17A	Sonde singole	Asa60M	B6
0701-2	Sonde singole	Asa60M	B6
0701-23	Sonde singole	Asa60M	B6
0701-3	Sonde singole	Asa60M	B6
0701-3A	Sonde singole	Asa60M	B6
0701-5	Sonde singole	Asa60M	B6
0701-6	Sonde singole	Asa60M	B6
0701-8	Sonde singole	Asa60M	B6
0701-9	Sonde singole	Asa60M	B6
0702-C	Sonde millimetriche parodontali	Asa35	G3
0702L-11	Sonde millimetriche parodontali	Asa60	E32
0702L-12	Sonde millimetriche parodontali	Asa60	E32

codice	descrizione	manico	pagina
0702L-12S	Sonde millimetriche parodontali	Asa60	E32
0702L-15	Sonde millimetriche parodontali	Asa60	G3
0703L-1	Sonde millimetriche parodontali · Williams	Asa60	G3
0703L-2	Sonde millimetriche parodontali · Merrit A	Asa60	G3
0703L-3	Sonde millimetriche parodontali · Merrit B	Asa60	G3
0703L-4	Sonde millimetriche parodontali · Goldman-Fox	Asa60	G3
0703L-5	Sonde millimetriche parodontali · University of Michigan	Asa60	G3
0703L-6	Sonde millimetriche parodontali	Asa60	G3
0704-11/12AF	Sonde doppie	Asa60	B8
0704-16D1	Sonde doppie	Asa60	B8
0704-16D2	Sonde doppie · Asa Com 2/2B	Asa60	B8
0704-23D1	Sonde doppie	Asa60	B8
0704-23D2	Sonde doppie	Asa60	B8
0704-6D9	Sonde doppie	Asa60	B8
0704-UT1	Sonde doppie · Cattoni	Asa60	B8
0705L-16GF	Combinazioni sonde · Sonde millimetriche · Goldman-Fox	Asa60	B10
0705L-16W	Combinazioni sonde · Sonde millimetriche · Williams	Asa60	B10
0705L-17GF	Combinazioni sonde · Sonde millimetriche · Goldman-Fox	Asa60	B10
0705L-17UM	Combinazioni sonde · Sonde millimetriche · University of Michigan	Asa60	B10
0705L-17W	Combinazioni sonde · Sonde millimetriche · Williams	Asa60	B10
0705L-23GF	Combinazioni sonde · Sonde millimetriche · Goldman-Fox	Asa60	B10
0705L-23UM	Combinazioni sonde · Sonde millimetriche · University of Michigan	Asa60	B10
0705L-23W	Combinazioni sonde · Sonde millimetriche · Williams	Asa60	B10
0705L-3GF	Sonde per canali · Goldman-Fox	Asa60	B10
0706L-2311	Combinazioni sonde · Sonde millimetriche	Asa60	B10
0706L-2312	Combinazioni sonde · Sonde millimetriche	Asa60	B11
0707L-GFW	Combinazioni sonde · Sonde millimetriche · Goldman-Fox Williams	Asa60	B11
0708-1N	Sonde doppie · Nabers	Asa60	B11
0708-2N	Sonde doppie · Nabers	Asa60	B11
0708L-2N	Sonde doppie · Nabers	Asa60	B11
0709-2	Sonde doppie	Asa60	B8
0709-2A	Sonde doppie	Asa60	B8
0709-3	Sonde doppie	Asa60	B9
0710-6D1	Sonde per canali	Asa60	B9
0710-6D2	Sonde per canali	Asa60	B9
0710-6D3	Sonde per canali	Asa60	B9
0800	Piastra millimetrica per endodonzia		B15
0800-1	Condensatori per trattamenti canalari	Asa60	B12
0800-2	Condensatori per trattamenti canalari	Asa60	B12
0800-3	Condensatori per trattamenti canalari	Asa60	B12

codice	descrizione	manico	pagina
0800-4	Condensatori per trattamenti canalari	Asa60	B12
0800-5	Condensatori per trattamenti canalari	Asa60	B12
0800-6	Condensatori per trattamenti canalari	Asa60	B12
0800-7	Condensatori per trattamenti canalari	Asa60	B12
0801-1	Otturatori per canali · Luks	Asa60	B13
0801-2	Otturatori per canali	Asa60	B13
0801-3	Otturatori per canali · Luks	Asa60	B13
0801-4	Otturatori per canali · Luks	Asa60	B13
0802L-1	Otturatori per canali	Asa60	B15
0802L-2	Condensatori	Asa60	B15
0802L-3	Condensatori	Asa60	B15
0802L-4	Condensatori	Asa60	B15
0870-1	Pinze per togliere tiranervi rotti		B16
0870-2	Pinze per togliere tiranervi rotti		B16
0900-1	Spatole per cemento		F22
0900-2	Spatole per cemento		F22
0903-0	Spatole per cemento		F22
0903-00	Spatole per cemento		F22
0903-1	Spatole per cemento		F22
0903-2	Spatole per cemento		F22
0903-3	Spatole per cemento		F22
0903-4	Spatole per cemento		F22
0999-1	Piastra in vetro per miscelazione		F22
1009-1	Spingi amalgama · retto, per retrograde		F21
1009-2	Spingi amalgama · curvo, per retrograde		F21
1009-3	Spingi amalgama · retto, per retrograde		F21
1009-4	Spingi amalgama · curvo, per retrograde		F21
1011-1	Spingi amalgama · small		F20
1011-2	Spingi amalgama · medium		F20
1011-3	Spingi amalgama · large		F20
1011-4	Spingi amalgama · jumbo		F20
1015-1	Spingi amalgama · medium/small		F20
1015-2	Spingi amalgama · medium/large		F20
1015-3	Spingi amalgama · medium/jumbo		F20
1020-1	Spingi amalgama · curvo		F21
1020-2	Spingi amalgama · 45°		F21
1020-2P	Spingi amalgama		F21
1020-3	Spingi amalgama · 90°		F21
1021-1	Spingi amalgama · retto, plastica autoclavabile		F21
1021-1P	Spingi amalgama · punta di ricambio retta, plastica autoclavabile		F21
1021-2	Spingi amalgama · 45°, plastica autoclavabile		F21
1021-2P	Spingi amalgama · punta di ricambio a 45°, plastica autoclavabile		F21
1021-3	Spingi amalgama · 90°, plastica autoclavabile		F21
1021-3P	Spingi amalgama · punta di ricambio a 90°, plastica autoclavabile		F21
1030-1	Mortai per amalgama		F20
1030-2	Mortai per amalgama		F20
1030-3	Mortai per amalgama		F20

codice	descrizione	manico	pagina	codice	descrizione	manico	pagina	codice	descrizione	manico	pagina	codice	descrizione	manico	pagina
1030-4	Mortai per osso		E32	1208-2	Strumenti per otturazioni plastiche	Asa60	F34	1221-31	Otturatori - Brunitori	Asa60	F31	1600-2	Strumenti per modellare e rifinire otturazioni · cleoide-discoide	Asa60	F38
1100-1	Spatole · Heidemann	Octagonal	F23	1208-3	Strumenti per otturazioni plastiche	Asa60	F34	1300	Applicatori per sottofondo	Asa35	F39	1600-3	Strumenti per modellare e rifinire otturazioni · cleoide-discoide	Asa60	F38
1100-2	Spatole · Heidemann	Octagonal	F23	1208T-1	Strumenti per otturazioni plastiche · con punte rivestite al nitruro di titanio	Asa60	F33	1301	Applicatori per sottofondo	Asa60	F39	1600-4	Strumenti per modellare e rifinire otturazioni · cleoide-discoide	Asa60	F38
1100-3	Spatole · Heidemann	Octagonal	F23	1208T-2	Strumenti per otturazioni plastiche · con punte rivestite al nitruro di titanio	Asa60	F33	1302	Applicatori per sottofondo	Asa60	F39	1601-1	Strumenti da smalto - finitori per bordi gengivali · distale · Black/26	Asa60	F18
1101-1	Spatole · Heidemann	Asa60	F23	1208T-3	Strumenti per otturazioni plastiche · con punte rivestite al nitruro di titanio	Asa60	F33	1303	Strumenti per l'applicazione di tinture e medicinali · Orban Loop	Octagonal	F39	1601-2	Strumenti da smalto - finitori per bordi gengivali · mesiale · Black/27	Asa60	F19
1101-2	Spatole · Heidemann	Asa60	F23	1209-1	Strumenti per otturazioni plastiche	Asa60	F34	1310-1	Strumenti per filo retrattore	Asa60	F38	1601-3	Strumenti da smalto - finitori per bordi gengivali · distale · Black/28	Asa60	F19
1101-3	Spatole · Heidemann	Asa60	F23	1209-2	Strumenti per otturazioni plastiche	Asa60	F34	1310-2	Strumenti per filo retrattore	Asa60	F38	1601-4	Strumenti da smalto - finitori per bordi gengivali · mesiale · Black/29	Asa60	F19
1102-1	Spatole · Heidemann	Asa60	F24	1209-3	Strumenti per otturazioni plastiche	Asa60	F34	1350-1	Strumenti per legature · per montare e rimuovere bande		H35	1602-1	Strumenti da smalto - finitori per bordi gengivali · distale · Black/77-78	Asa60	F19
1102-2	Spatole · Heidemann	Asa60	F24	1209T-2	Strumenti per otturazioni plastiche · con punte rivestite al nitruro di titanio	Asa60	F33	1350-2	Strumenti per legature · per montare e rimuovere bande		H35	1602-2	Strumenti da smalto - finitori per bordi gengivali · mesiale · Black/79-80	Asa60	F19
1102-3	Spatole · Heidemann	Asa60	F24	1210-1	Strumenti per composito · Asa Com 14/14B	Asa60	F35	1351-1	Strumenti per legature · per montare e rimuovere bande		H35	1603-1	Strumenti da smalto - scalpelli · Black/53-54	Asa60	F18
1102T-1	Spatole · con punte rivestite al nitruro di titanio · Heidemann	Asa60	F24	1210-2	Strumenti per otturazioni plastiche	Asa60	F35	1352-1	Strumento per elastici		H35	1603-2	Strumenti da smalto - scalpelli · Black/51-52	Asa60	F18
1102T-2	Spatole · con punte rivestite al nitruro di titanio · Heidemann	Asa60	F24	1210-3	Strumenti per otturazioni plastiche · Asa Com 15/15B	Asa60	F50	1355-1	Porta tamponi · per legature elastiche · Luniatschek	Octagonal	F39	1604-02	Strumenti da smalto - preparazione cavità · Wedelstaedt	Asa60	F18
1102T-3	Spatole · con punte rivestite al nitruro di titanio · Heidemann	Asa60	F24	1210T-2	Strumenti per otturazioni plastiche · con punte rivestite al nitruro di titanio	Asa60	F33	1355-2	Porta tamponi · per legature elastiche · Luniatschek	Octagonal	F39	1604-04	Strumenti da smalto - preparazione cavità · Wedelstaedt	Asa60	F18
1200-1	Otturatori per amalgama	Asa60	F26	1211-0T	Otturatori per amalgama · Tanner	Asa60	F28	1400-1	Otturatori per amalgama · Markley	Asa60	F29	1604-06	Strumenti da smalto - preparazione cavità · Wedelstaedt	Asa60	F18
1200-2	Otturatori per amalgama	Asa60	F26	1211-1T	Otturatori per amalgama · Tanner	Asa60	F28	1400-2	Otturatori per amalgama · Markley	Asa60	F29	1700-0	Escavatori - cucchiali	Asa60	F13
1200-3	Otturatori per amalgama	Asa60	F26	1211-2T	Otturatori per amalgama · Tanner	Asa60	F28	1400-3	Otturatori per amalgama · Markley	Asa60	F29	1700-1	Escavatori - cucchiali ovali	Asa60	F13
1200-4	Otturatori per amalgama	Asa60	F26	1211-3T	Otturatori per amalgama · Tanner	Asa60	F28	1400-4	Otturatori per amalgama · Markley	Asa60	F29	1700-2	Escavatori - cucchiali	Asa60	F13
1200-5	Otturatori per amalgama	Asa60	F26	1212-01	Otturatori per amalgama · Marquette	Asa60	F28	1400-5	Otturatori per amalgama · Markley	Asa60	F29	1700-3	Escavatori - cucchiali	Asa60	F13
1200T-1	Otturatori per amalgama · con punte rivestite al nitruro di titanio	Asa60	F25	1213-H1	Otturatori per amalgama · Hollenback	Asa60	F28	1400-6	Otturatori per amalgama · Markley	Asa60	F29	1700-4	Escavatori - cucchiali	Asa60	F13
1200T-2	Otturatori per amalgama · con punte rivestite al nitruro di titanio	Asa60	F25	1213-H2	Otturatori per amalgama · Hollenback	Asa60	F28	1401-0	Otturatori per amalgama · Foc	Asa60	F30	1701-1	Escavatori - cucchiali	Asa60	F13
1200T-3	Otturatori per amalgama · con punte rivestite al nitruro di titanio	Asa60	F25	1213-H3	Otturatori per amalgama · Asa Com 12/12B · Hollenback	Asa60	F49	1401-0S	Otturatori per amalgama · Foc	Asa60	F30	1701-2	Escavatori - cucchiali	Asa60	F13
1201-1	Otturatori per amalgama	Asa60	F26	1213-H4	Otturatori per amalgama · Hollenback	Asa60	F28	1401-1	Otturatori per amalgama · Asa Com 11/11B · Foc	Asa60	F49	1702-6	Escavatori - cucchiali	Asa60	F14
1201-1L	Otturatori per amalgama · Asa Com 9/9B	Asa60	F49	1214-2	Otturatori - Brunitori · Ladmore	Asa60	F31	1401-1S	Otturatori per amalgama · Foc	Asa60	F30	1703-14	Escavatori - cucchiali	Asa60	F14
1201-2	Otturatori per amalgama	Asa60	F26	1214-3	Otturatori - Brunitori · Ladmore	Asa60	F31	1401-2	Otturatori per amalgama · Foc	Asa60	F30	1704-17	Escavatori - cucchiali	Asa60	F14
1201-2L	Otturatori per amalgama · Asa Com 10/10B	Asa60	F49	1214-A	Otturatori - Brunitori	Asa60	F31	1401-2S	Otturatori per amalgama · Foc	Asa60	F30	1704-17W	Escavatori - cucchiali ovali	Asa60	F15
1201-3	Otturatori per amalgama	Asa60	F26	1215-18	Otturatori - Brunitori · Ball	Asa60	F31	1500-02	Strumenti per modellare amalgama/cera · Hollenback	Asa60	F36	1705-18	Escavatori - cucchiali	Asa60	F15
1201-3L	Otturatori per amalgama	Asa60	F26	1215-27S	Otturatori - Brunitori · Ball	Asa60	F31	1500-3	Strumenti per modellare amalgama/cera · Hollenback	Asa60	F36	1705-18W	Escavatori - cucchiali ovali	Asa60	F15
1202-1	Otturatori per amalgama	Asa60	F27	1215-29	Otturatori - Brunitori · Ball	Asa60	F31	1500-3S	Strumenti per modellare amalgama/cera · Hollenback	Asa60	F36	1706-19	Escavatori - cucchiali	Asa60	F14
1202-1L	Otturatori per amalgama	Asa60	F27	1215-W3	Otturatori - Brunitori	Asa60	F31	1501-1	Strumenti per modellare amalgama/cera · Ward	Asa60	F36	1706-19W	Escavatori - cucchiali ovali	Asa60	F15
1202-2	Otturatori per amalgama	Asa60	F27	1216-1	Strumenti per otturazioni plastiche · Woodson	Asa60	F35	1501-1S	Strumenti per modellare amalgama/cera · Ward	Asa60	F36	1707-39	Escavatori - cucchiali	Asa60	F14
1202-2L	Otturatori per amalgama	Asa60	F27	1216-2	Strumenti per otturazioni plastiche · Woodson	Asa60	F35	1501-2	Strumenti per modellare amalgama/cera · Ward	Asa60	F36	1709-31L	Escavatori canalari	Asa60	B15
1202-3	Otturatori per amalgama	Asa60	F27	1216-3	Strumenti per otturazioni plastiche · Woodson	Asa60	F35	1502-1	Strumenti per modellare amalgama/cera · Ward	Asa60	F37	1709-32L	Escavatori canalari	Asa60	B15
1202-3L	Otturatori per amalgama	Asa60	F27	1217-11	Strumenti per otturazioni plastiche	Asa60	F35	1503-2	Strumenti per modellare amalgama/cera · Frahm	Asa60	K13	1709-33L	Escavatori canalari	Asa60	B15
1202-4	Otturatori per amalgama	Asa60	F27	1218-6	Strumenti per otturazioni plastiche	Asa60	F35	1504-1	Strumenti per modellare e rifinire otturazioni · interprossimale	Asa60	F37	1710-14	Escavatori · SS. White	Asa60	F16
1202-4L	Otturatori per amalgama	Asa60	F27	1219-179	Strumenti per otturazioni plastiche · Asa Com 5/5B	Asa60	F48	1504-2	Strumenti per modellare e rifinire otturazioni · interprossimale Off-angle · Asa Com 6/6B	Asa60	F48	1710-17	Escavatori · SS. White	Asa60	F16
1202T-1	Otturatori per amalgama · con punte rivestite al nitruro di titanio	Asa60	F25	1220-1	Strumenti per composito · Felt	Alu60	F32	1505-3	Strumenti per modellare e rifinire otturazioni	Asa60	F37	1710-18	Escavatori · SS. White	Asa60	F16
1202T-2	Otturatori per amalgama · con punte rivestite al nitruro di titanio	Asa60	F25	1220-2	Strumenti per composito · Felt	Alu60	F32	1505-A	Strumenti per modellare e rifinire otturazioni	Asa60	F37	1710-19	Escavatori · SS. White	Asa60	F16
1203-1	Otturatori per amalgama · Asa Com 3/3B	Asa60	F48	1220-3	Strumenti per composito · Felt	Alu60	F32	1506-104	Strumenti per modellare e rifinire otturazioni	Asa60	F37	1710-20	Escavatori · SS. White	Asa60	F16
1203-2	Otturatori per amalgama	Asa60	F27	1220-4	Strumenti per composito · Felt	Alu60	F32	1507-8	Strumenti per modellare e rifinire otturazioni · Wiland	Asa60	F37	1710-5	Escavatori · SS. White	Asa60	F16
1203-3	Otturatori per amalgama · Asa Com 4/4B	Asa60	F48	1220-5	Strumenti per composito · Felt	Alu60	F32	1600-1	Strumenti per modellare e rifinire otturazioni · cleoide-discoide	Asa60	F38	1711-1	Escavatori · Darby-Perry	Asa60	F17
1204-1	Otturatori - Brunitori · Westcott	Asa60	F31	1220-6	Strumenti per composito · Felt	Alu60	F32					1711-11	Escavatori · Darby-Perry	Asa60	F17
1204-2	Otturatori - Brunitori · Westcott	Asa60	F31	1220-B2	Otturatori - Brunitori · Asa Com 8/8B · New York Univeristy	Asa60	F49					1711-12	Escavatori · Darby-Perry	Asa60	F17
1204T-1	Otturatori per amalgama · con punte rivestite al nitruro di titanio · Westcott	Asa60	F25									1711-2	Escavatori · Darby-Perry	Asa60	F17
1205-1	Otturatori per amalgama · Ward	Asa60	F28									1711-21	Escavatori · Darby-Perry	Asa60	F17
1205-2	Otturatori per amalgama · Ward	Asa60	F28									1711-22	Escavatori · Darby-Perry	Asa60	F17
1206-1	Strumenti per otturazioni plastiche	Asa60	F34												
1206-2	Strumenti per otturazioni plastiche	Asa60	F34												
1207-1	Strumenti per otturazioni plastiche	Asa60	F34												
1207-2	Strumenti per otturazioni plastiche	Asa60	F34												
1208-1	Strumenti per otturazioni plastiche	Asa60	F34												

codice	descrizione	manico	pagina	codice	descrizione	manico	pagina	codice	descrizione	manico	pagina	codice	descrizione	manico	pagina
1711-243	Escavatori - ASH	Asa60	F15	1809-6	Curette e Scaler - Goldman-Fox	Asa60	G6	1834-3	Scalpellini e sgorbie per parodontologia - Buckley		G27	1856-1	Scollaperiostio ed Elevatori - Williger		E25
1711-31	Escavatori - Darby-Perry	Asa60	F17	1810-07	Lime - Hirschfeld	Asa60	G22	1835-3	Scalpellini e sgorbie per parodontologia - Partsch		G28	1856-2	Scollaperiostio ed Elevatori - Williger		E25
1711-32	Escavatori - Darby-Perry	Asa60	F17	1811-37	Scalpellini chirurgici - back-action - Rhodes	Asa60	G26	1835-4	Scalpellini e sgorbie per parodontologia - Partsch		G28	1857-1	Scollaperiostio ed Elevatori - Williger		E25
1711-41	Escavatori - Darby-Perry	Asa60	F17	1812-02S	Lime - Sugarman	Asa60	G22	1835-5	Scalpellini e sgorbie per parodontologia - Partsch		G28	1857-2	Scollaperiostio ed Elevatori - Williger		E25
1711-42	Escavatori - Darby-Perry	Asa60	F17	1812-04S	Lime - Sugarman	Asa60	G22	1835-6	Scalpellini e sgorbie per parodontologia - Partsch		G28	1858-1	Scollaperiostio ed Elevatori - König		E25
1711-G2	Escavatori - ASH	Asa60	F15	1813-10	Lime - Schluger	Asa60	G22	1836-3	Scalpellini e sgorbie per parodontologia - Partsch		G28	1870-1	Apribocca - Molt		C33
1800-1	Scalpellini e sgorbie per parodontologia - Ochsenbein		G27	1815-11	Bisturi per gengivectomia - Goldman-Fox	Asa60	G25	1836-4	Scalpellini e sgorbie per parodontologia - Partsch		G28	1870-2	Apribocca - Molt		C33
1800-2	Scalpellini e sgorbie per parodontologia - Ochsenbein		G27	1815-7	Bisturi per gengivectomia - Goldman-Fox	Asa60	G25	1836-5	Scalpellini e sgorbie per parodontologia - Partsch		G28	1871-1	Apribocca - Roser-Koenig		C33
1801-1	Scalpellini chirurgici - TG	Asa60	G26	1815-8	Bisturi per gengivectomia - Goldman-Fox	Asa60	G25	1836-6	Scalpellini e sgorbie per parodontologia - Partsch		G28	1871-2	Apribocca - Roser-Koenig		C33
1801-2	Scalpellini chirurgici - TG	Asa60	G26	1815-9	Bisturi per gengivectomia - Goldman-Fox	Asa60	G25	1837-3	Scalpellini e sgorbie per parodontologia - Partsch		G28	1880	Martelli chirurgici - Partsch		E16
1801-D	Scalpellini chirurgici - TG	Asa60	G26	1816-04	Bisturi per gengivectomia - Buck	Asa60	G25	1837-4	Scalpellini e sgorbie per parodontologia - Partsch		G28	1881	Martelli chirurgici - Mead		E16
1802-3	Scalpellini chirurgici - Ochsenbein	Asa60	G26	1816-06	Bisturi per gengivectomia - Buck	Asa60	G24	1837-5	Scalpellini e sgorbie per parodontologia - Partsch		G28	1881-R	Inseriti di ricambio per martelli - Teflon		E16
1802-4	Scalpellini chirurgici - Ochsenbein	Asa60	G26	1817-02	Bisturi per gengivectomia - Sanders	Asa60	G25	1837-6	Scalpellini e sgorbie per parodontologia - Partsch		G28	1882	Martelli chirurgici - Mead		G29
1803-1	Bisturi per gengivectomia - Kirkland	Asa60	G24	1817-05	Bisturi per gengivectomia - Sanders	Asa60	G25	1838-3	Scalpellini e sgorbie per parodontologia - Partsch		G28	1884	Martelli chirurgici - Vickers		G29
1803-2	Bisturi per gengivectomia - Kirkland	Asa60	G24	1817-20	Bisturi per gengivectomia - USC Towner (University of South California)	Asa60	G25	1838-4	Scalpellini e sgorbie per parodontologia - Partsch		G28	1885	Martelli chirurgici - Herbert		G29
1803-D	Bisturi per gengivectomia - Kirkland	Asa60	G24	1818-20	Bisturi per gengivectomia - USC Towner (University of South California)	Asa60	G25	1838-5	Scalpellini e sgorbie per parodontologia - Partsch		G28	1890-1F	Pietre per affilare - grana fine		G32
1804-1	Bisturi per gengivectomia - Orban	Asa60	G24	1819-CK3	Bisturi per gengivectomia - Crane-Kaplan	Asa60	G25	1838-6	Scalpellini e sgorbie per parodontologia - Partsch		G28	1890-1M	Pietre per affilare - grana media		G32
1804-2	Bisturi per gengivectomia - Orban	Asa60	G24	1820-Z	Curette e Scaler - Zerfing-Chisel	Asa60	G4	1839-1	Scalpellini Freer taglio singolo - Freer		E16	1890-2	Pietre per affilare		G32
1804-D	Bisturi per gengivectomia - Orban	Asa60	G24	1821-02	Curette e Scaler - Barnhart	Asa60	G5	1839-2	Scalpellini Freer taglio singolo - Freer		E16	1890-3	Pietre per affilare		G32
1805-02	Curette e Scaler - Langer	Asa60	G5	1821-06	Curette e Scaler - Barnhart	Asa60	G5	1839-3	Scalpellini Freer taglio singolo - Freer		E16	1890-4	Pietre per affilare		G32
1805-04	Curette e Scaler - Langer	Asa60	G5	1822-ME1	Curette e Scaler	Asa60	G5	1840-1	Scalpellini graduati - retti		E17	1890-5	Pietre per affilare		G32
1806-02	Curette e Scaler	Asa60	G4	1823-R04	Curette e Scaler - Rule	Asa60	G5	1840-2	Scalpellini graduati - curvi		E17	1890-6	Pietre per affilare		G33
1806-14	Curette e Scaler - Columbia	Asa60	G4	1824-14	Curette e Scaler - anteriore - Indiana University	Asa60	G5	1840-3	Scalpellini graduati - retti		E17	1890-7	Pietre per affilare		G33
1806-2RL	Curette e Scaler - Columbia	Asa60	G4	1824-18	Curette e Scaler - posteriore - Indiana University	Asa60	G5	1840-4	Scalpellini graduati - curvi		E17	1891-1	Pietre per affilare		G33
1806-412	Curette e Scaler - Columbia	Asa60	G4	1825-12	Curette e Scaler - Mc Call	Asa60	G7	1841-1	Frese carotatrici Trepine con punte millimetriche		E34	1900-1L	Scaler - sinistro	Asa60	G15
1806-414	Curette e Scaler - Columbia	Asa60	G4	1825-12A	Curette e Scaler - Mc Call	Asa60	G7	1841-2	Frese carotatrici Trepine con punte millimetriche		E34	1900-1R	Scaler - destro	Asa60	G15
1806-4RL	Curette e Scaler - Columbia	Asa60	G4	1825-12A	Curette e Scaler - Mc Call	Asa60	G7	1841-3	Frese carotatrici Trepine con punte millimetriche		E34	1900-2L	Scaler - sinistro	Asa60	G15
1807-02	Curette Gracey - Gracey	Asa60	G11	1825-14	Curette e Scaler - Mc Call	Asa60	G7	1841-4	Frese carotatrici Trepine con punte millimetriche		E34	1900-2R	Scaler - destro	Asa60	G15
1807-02AF	Curette Gracey - AF - Gracey	Asa60	G12	1825-14S	Curette e Scaler - Mc Call	Asa60	G7	1844-3	Mucotomi - retti		E26	1900-M23	Scaler - universal scaler	Asa60	G14
1807-02MF	Curette Gracey - MF - Gracey	Asa60	G13	1825-18S	Curette e Scaler - Mc Call	Asa60	G7	1844-3C	Mucotomi - curvi		E26	1901-1	Scaler	Asa60	G15
1807-04	Curette Gracey - Gracey	Asa60	G11	1825-20	Curette e Scaler - Mc Call	Asa60	G7	1844-4	Mucotomi - retti		E26	1902-1	Scaler - Towner Jacqueline	Asa60	G14
1807-04AF	Curette Gracey - AF - Gracey	Asa60	G12	1826-T03	Curette e Scaler - Taylor	Asa60	G8	1844-4C	Mucotomi - curvi		E26	1902-2	Scaler - Towner Jacqueline	Asa60	G14
1807-04MF	Curette Gracey - MF - Gracey	Asa60	G13	1827-204	Curette e Scaler	Asa60	G8	1844-5	Mucotomi - retti		E26	1903	Scaler - Towner	Asa60	G14
1807-06	Curette Gracey - Gracey	Asa60	G11	1827-204S	Curette e Scaler	Asa60	G8	1844-5C	Mucotomi - curvi		E26	1904-H5	Scaler	Asa60	G14
1807-06AF	Curette Gracey - AF - Gracey	Asa60	G12	1829-CK6	Curette e Scaler - Crane-Kaplan	Asa60	G8	1844-6	Mucotomi - retti		E26	1904-H6	Scaler	Asa60	G14
1807-06MF	Curette Gracey - MF - Gracey	Asa60	G13	1829-CK6S	Curette e Scaler - Mini Crane-Kaplan	Asa60	G8	1844-6C	Mucotomi - curvi		E26	1905-02	Scaler	Asa60	G14
1807-08	Curette Gracey - Gracey	Asa60	G11	1830-YG08	Curette e Scaler - Younger-Good	Asa60	G8	1846	Macinatori per osso		E27	1906-33	Scaler	Asa60	G15
1807-08AF	Curette Gracey - AF - Gracey	Asa60	G12	1831-32	Curette e Scaler - Jacqueline	Asa60	G9	1849-1	Scollaperiostio ed Elevatori - Partsch	Asa60	E24	1909-H5	Scaler	Asa60	G15
1807-08MF	Curette Gracey - MF - Gracey	Asa60	G13	1831-33	Curette e Scaler - Jacqueline	Asa60	G9	1855-22	Scollaperiostio ed Elevatori - scollatore - Seldin		E25	1909-H6	Scaler	Asa60	G15
1807-10	Curette Gracey - Gracey	Asa60	G11	1831-35	Curette e Scaler - Jacqueline	Asa60	G9	1855-23	Scollaperiostio ed Elevatori - scollatore - Seldin		E25	1909-H7	Scaler - Hygienist	Asa60	G15
1807-11MD	Curette Gracey - mesiale-distale - Gracey	Asa60	G11	1831-38	Curette e Scaler - Jacqueline	Asa60	G9					2000-1	Cucchiari alveolari - Hemingway	Asa60	C45
1807-12	Curette Gracey - Gracey	Asa60	G11	1832-1	Scalpellini e sgorbie per parodontologia - Gardner		G27								
1807-12AF	Curette Gracey - AF - Gracey	Asa60	G12	1832-2	Scalpellini e sgorbie per parodontologia - Gardner		G27								
1807-12MF	Curette Gracey - MF - Gracey	Asa60	G13	1832-5	Scalpellini e sgorbie per parodontologia - Gardner		G27								
1807-13MD	Curette Gracey - mesiale-distale - Gracey	Asa60	G11	1832-5R	Scalpellini e sgorbie per parodontologia - Gardner		G27								
1807-14	Curette Gracey - Gracey	Asa60	G11	1832-6	Scalpellini e sgorbie per parodontologia - Gardner		G27								
1807-14AF	Curette Gracey - AF - Gracey	Asa60	G12	1833-1W	Scalpellini e sgorbie per parodontologia - Wakefield		G27								
1807-14MF	Curette Gracey - MF - Gracey	Asa60	G13	1833-2W	Scalpellini e sgorbie per parodontologia - Wakefield		G27								
1807-16	Curette Gracey - Gracey	Asa60	G11												
1807-16AF	Curette Gracey - AF - Gracey	Asa60	G12												
1807-16MF	Curette Gracey - MF - Gracey	Asa60	G13												
1807-18	Curette Gracey - Gracey	Asa60	G11												
1808-1	Curette e Scaler - De Marco	Asa60	G5												
1808-2	Curette e Scaler - De Marco	Asa60	G5												
1809-1	Curette e Scaler - Goldman-Fox	Asa60	G6												
1809-2	Curette e Scaler - Goldman-Fox	Asa60	G6												
1809-21	Curette e Scaler - Goldman-Fox	Asa60	G6												
1809-3	Curette e Scaler - Goldman-Fox	Asa60	G6												
1809-4	Curette e Scaler - Goldman-Fox	Asa60	G6												
1809-5	Curette e Scaler - Goldman-Fox	Asa60	G6												

codice	descrizione	manico	pagina	codice	descrizione	manico	pagina	codice	descrizione	manico	pagina	codice	descrizione	manico	pagina
2005-64	Lime per alveolotomia · Miller		E21	2300-S	Martelletti levacorone		F40	2617-1	Divaricatori · retto, acuto · Williger		C35	2730-1	Vassoi portastrumenti in acciaio inox · per 16 strumenti		15
2006-10	Lime per alveolotomia		E21	2301	Punte per martelletti levacorone		F40	2617-2	Divaricatori · sinistro, acuto · Williger		C35	2730-2	Vassoi portastrumenti in acciaio inox · per 23 strumenti		15
2007-12A	Lime per alveolotomia		G23	2302	Punte per martelletti levacorone		F40	2617-3	Divaricatori · destro acuto · Williger		C35	2730-3	Kit di strumenti per diga · griglia portastrumenti		F10
2007-12CA	Lime per alveolotomia		G23	2305-D	Martelletti levacorone		F40	2618-1	Divaricatori · retto, acuto · Williger		C35	2730-4	Vassoi portastrumenti in acciaio inox · per 8 strumenti		17
2008-12	Lime per alveolotomia		G23	2306	Punte per martelletti levacorone		F40	2618-2	Divaricatori · sinistro, arrotondato · Williger		C35	2730-5	Vassoi portastrumenti in acciaio inox · per 4 strumenti		17
2013-2	Cucchiai alveolari · modello U.S.A.		G21	2307	Punte per martelletti levacorone		F40	2620-1	Divaricatori · Middeldorpf		C37	2731-1	Kit di strumenti per diga		F11
2013-2L	Cucchiai alveolari · modello U.S.A.		G21	2308	Punte per martelletti levacorone		F40	2620-2	Divaricatori · Middeldorpf		C37	2737-1	Vaschette in acciaio Inox		I12
2013-2R	Cucchiai alveolari · modello U.S.A.		G21	2320	Strumenti levacorone e apricorone		F40	2620-3	Divaricatori · Middeldorpf		C37	2737-2	Vaschette in acciaio Inox		I12
2014-3	Cucchiai alveolari		C45	2331-1	Pinze per togliere anelli di rame · rette · Furrer		F43	2621-1	Divaricatori · Langenbeck		C36	2737-3	Vaschette in acciaio Inox		I12
2015-0	Cucchiai alveolari · Williger		E21	2331-2	Pinze per togliere anelli di rame · curve · Furrer		F43	2621-2	Divaricatori · Langenbeck		C36	2737-4	Vaschette in acciaio Inox		I12
2015-00	Cucchiai alveolari · Williger		G21	2340-0	Apricorone		F41	2621-3	Divaricatori · Langenbeck		C36	2750-1	Distributori per bicchieri		A20
2015-1	Cucchiai alveolari · Williger		G21	2340-1	Apricorone		F41	2621-4	Divaricatori · Langenbeck		C36	2750-2	Distributori per bicchieri		A20
2016-0	Cucchiai alveolari		G21	2340-2	Apricorone		F41	2621-5	Divaricatori · Langenbeck		C36	2751-1	Distributori di palline di cotone in acciaio inox		I19
2016-00	Cucchiai alveolari		G21	2340-3	Apricorone		F41	2622-1	Divaricatori · Langenbeck		C36	2770-1	Cassette portastrumenti in acciaio inox · large · per 20 strumenti - Blu		I2
2016-1	Cucchiai alveolari		G21	2400	Pinzette per posizionare attacchi adesivi		H34	2622-2	Divaricatori · Langenbeck		C36	2770-1A	Cassette portastrumenti in acciaio inox · large · per 20 strumenti - Arancione		I2
2100-CS	Manici per specchietti · modello Americano	Octagonal	B20	2401	Pinzette per posizionare attacchi adesivi		H34	2622-3	Divaricatori · Langenbeck		C36	2770-1R	Cassette portastrumenti in acciaio inox · large · per 20 strumenti - Rosso		I2
2101-CS	Manici per specchietti · modello Americano	Asa60	B20	2402	Pinzette per posizionare attacchi adesivi		H34	2622-4	Divaricatori · Langenbeck		C36	2770-1V	Cassette portastrumenti in acciaio inox · large · per 20 strumenti - Verde		I2
2102-CS	Manici per specchietti · modello Americano	Exagonal	B20	2410	Spingibande · Mershon		H34	2622-5	Divaricatori · Langenbeck		C36	2770-2	Cassette portastrumenti in acciaio inox · large · per 15 strumenti - Blu		I2
2104-B	Manici per specchietti	Alu80	B19	2411	Adattatori di bande		H34	2623-1	Divaricatori · Kocher		C36	2770-2A	Cassette portastrumenti in acciaio inox · large · per 15 strumenti - Arancione		I2
2104-C	Manici per specchietti	Alu80	B19	2412	Spingibande · utilizzato in tutti gli sterilizzatori a caldo		H34	2623-2	Divaricatori · Kocher		C36	2770-2R	Cassette portastrumenti in acciaio inox · large · per 15 strumenti - Rosso		I2
2104-G	Manici per specchietti	Alu80	B19	2450	Pinza tendielastici · per catenelle e separatori		H35	2624-1	Divaricatori · Kocher		C36	2770-2V	Cassette portastrumenti in acciaio inox · large · per 15 strumenti - Verde		I2
2104-R	Manici per specchietti	Alu80	B19	2500-1	Strumenti per Corone · Böhm		F43	2624-2	Divaricatori · Kocher		C36	2770-3	Cassette portastrumenti in acciaio inox · large · per 10 strumenti - Blu		I2
2104-V	Manici per specchietti	Alu80	B19	2500-2	Strumenti per Corone · Böhm		K29	2625-1	Divaricatori per spina nasale		C36	2770-3A	Cassette portastrumenti in acciaio inox · large · per 10 strumenti - Arancione		I2
2200E-4	Specchietti per bocca		B18	2550-1	Strumenti per Corone · Böhm		F43	2626-1	Divaricatori per spina nasale		C36	2770-3R	Cassette portastrumenti in acciaio inox · large · per 10 strumenti - Rosso		I2
2200E-5	Specchietti per bocca		B18	2550-2	Strumenti per Corone · Böhm		K29	2627	Divaricatori		C37	2770-3V	Cassette portastrumenti in acciaio inox · large · per 10 strumenti - Verde		I2
2200E-6	Specchietti per bocca		B18	2555-1	Calibri · per cera · Iwanson		F42	2628-1	Divaricatori labiale		C37	2770-G	Blocca strumenti · per 10 posti - Blu - silicone		I3
2201E-4	Specchietti per bocca		B18	2555-2	Calibri · per metallo · Iwanson		F42	2628-2	Divaricatori apribile		E10	2770-GA	Blocca strumenti · per 10 posti - Arancione - silicone		I3
2201E-5	Specchietti per bocca		B18	2556-1	Calibri · per alluminio, divisione in millimetri e pollici		K30	2650-02	Sonde seno mascellare · Bowman		C37	2770-GR	Blocca strumenti · per 10 posti - Rosso - silicone		I3
2210E-4	Specchietti per bocca · modello Americano		B20	2556-2	Calibri · per alluminio, divisione in millimetri e pollici · Townley		K30	2650-08	Sonde seno mascellare · Bowman		C37	2770-GV	Blocca strumenti · per 10 posti - Verde - silicone		I3
2210E-5	Specchietti per bocca · modello Americano		B20	2556-3	Calibri · Jameson		K30	2651-1	Sonde seno mascellare		C37	2771-1	Cassette portastrumenti in acciaio inox · medium · per 10 strumenti - Blu		I2
2211E-4	Manici per specchietti · modello Americano		B20	2556-4	Calibri		E33	2651-2	Sonde seno mascellare		C37	2771-1A	Cassette portastrumenti in acciaio inox · medium · per 10 strumenti - Arancione		I2
2211E-5	Manici per specchietti · modello Americano		B20	2557-1	Calibri		K30	2700-G	Vassoi portastrumenti in acciaio inox · per 7 strumenti		16				
2220E-4	Specchietti per bocca · Rhodium		B18	2601	Divaricatori per labbra · Columbia		C34	2700-L	Vassoi portastrumenti in acciaio inox · vassoio non forato		16				
2220E-5	Specchietti per bocca · Rhodium		B18	2602-1	Divaricatori per labbra · Sternberg		C34	2700-U	Vassoi portastrumenti in acciaio inox · coperchio non forato		16				
2221-4	Specchietti per bocca · Titanium		B18	2602-2	Divaricatori per labbra · Sternberg		E11	2702-L	Vassoi portastrumenti in acciaio inox · vassoio forato		16				
2221-5	Specchietti per bocca · Titanium		B18	2602-3	Divaricatori per labbra · Sternberg		C34	2702-U	Vassoi portastrumenti in acciaio inox · coperchio forato		16				
2230-5	Specchietti per bocca		B18	2604	Abbassalingua · divaricatore per guance · University of Minnesota		C34	2720-L	Vassoi portastrumenti in acciaio inox · vassoio non forato		15				
2231-5CS	Specchietti per bocca · modello Americano		B20	2605	Abbassalingua		C34	2720-U	Vassoi portastrumenti in acciaio inox · coperchio non forato		14				
2240-1	Manici per specchietti		B19	2606	Abbassalingua		C34	2721-L	Vassoi portastrumenti in acciaio inox · vassoio forato		14				
2240-2	Manici per specchietti		B19	2607	Abbassalingua · Buchwald		C34	2721-U	Vassoi portastrumenti in acciaio inox · coperchio forato		14				
2240-3	Manici per specchietti		B19	2608	Abbassalingua · Brünings		C34	2723-L	Vassoi portastrumenti in acciaio inox · vassoio non forato		17				
2240-4	Manici per specchietti		B19	2609-2	Divaricatori per labbra · Orringer medium		C34	2723-U	Vassoi portastrumenti in acciaio inox · coperchio non forato		17				
2250-1	Specchietti per fotografie · superfici occlusali		B17	2611-1	Divaricatori · arrotondato		C35	2724-L	Vassoi portastrumenti in acciaio inox · vassoio non forato		17				
2250-2	Specchietti per fotografie · superfici occlusali		B17	2611-2	Divaricatori · arrotondato		C35	2724-U	Vassoi portastrumenti in acciaio inox · coperchio non forato		17				
2250-3	Specchietti per fotografie · superfici vestibolari		B17	2613-1	Divaricatori · acuto · Senn-Miller		C35								
2250-4	Specchietti per fotografie · superfici linguali		B17	2613-2	Divaricatori · arrotondato · Senn-Miller		C35								
2250-5	Specchietti per fotografie · superfici linguali		B17	2615-1	Divaricatori · Kilner		C35								
2300-D	Martelletti levacorone		F40	2616-1	Divaricatori · Farabeuf		C35								

codice	descrizione	manico	pagina	codice	descrizione	manico	pagina	codice	descrizione	manico	pagina	codice	descrizione	manico	pagina
2771-1R	Cassette portastrumenti in acciaio inox - medium - per 10 strumenti - Rosso		12	2800-L5	Portaimpronta forati in alluminio		J36	2802-L6	Portaimpronta non forati in acciaio inox		J32	2803-U3	Portaimpronta non forati in acciaio inox - NEW SUPER		J20
2771-1V	Cassette portastrumenti in acciaio inox - medium - per 10 strumenti - Verde		12	2800-L6	Portaimpronta forati in alluminio		J36	J34				2803-U4	Portaimpronta non forati in acciaio inox - NEW SUPER		J20
2771-2	Cassette portastrumenti in acciaio inox - medium - per 5 strumenti - Blu		12	2800-L6D	Portaimpronta forati in alluminio		J36	2802-L6D	Portaimpronta non forati in acciaio inox		J32	2803-U5	Portaimpronta non forati in acciaio inox - NEW SUPER		J20
2771-2A	Cassette portastrumenti in acciaio inox - medium - per 5 strumenti - Arancione		12	2800-L6S	Portaimpronta forati in alluminio		J36	2802-L6S	Portaimpronta non forati in acciaio inox		J32	2804-L1	Portaimpronta forati in acciaio inox - PERMA-LOCK		J4
2771-2R	Cassette portastrumenti in acciaio inox - medium - per 5 strumenti - Rosso		12	2800-U1	Portaimpronta forati in alluminio		J36	2802-U1	Portaimpronta non forati in acciaio inox		J32	2804-L1P	Portaimpronta forati in acciaio inox - PERMA-LOCK		J4
2771-2V	Cassette portastrumenti in acciaio inox - medium - per 5 strumenti - Verde		12	2800-U2	Portaimpronta forati in alluminio		J36	2802-U1A	Portaimpronta non forati in acciaio inox - ANATOMIC		J34	2804-L2	Portaimpronta forati in acciaio inox - PERMA-LOCK		J4
2771-G	Blocca strumenti - per 5 posti - Blu - silicone		13	2800-U3	Portaimpronta forati in alluminio		J36	2802-U2	Portaimpronta non forati in acciaio inox		J32	J6			
2771-GA	Blocca strumenti - per 5 posti - Arancione - silicone		13	2800-U4	Portaimpronta forati in alluminio		J36	2802-U2A	Portaimpronta non forati in acciaio inox - ANATOMIC		J34	2804-L2D	Portaimpronta forati in acciaio inox - PERMA-LOCK		J4
2771-GR	Blocca strumenti - per 5 posti - Rosso - silicone		13	2800-U5	Portaimpronta forati in alluminio		J36	2802-U3	Portaimpronta non forati in acciaio inox		J32	2804-L2S	Portaimpronta forati in acciaio inox - PERMA-LOCK		J4
2771-GV	Blocca strumenti - per 5 posti - Verde - silicone		13	2800-U6	Portaimpronta forati in alluminio		J36	2802-U3A	Portaimpronta non forati in acciaio inox - ANATOMIC		J34	2804-L3	Portaimpronta forati in acciaio inox - PERMA-LOCK		J4
2772-1	Cassette portastrumenti in acciaio inox - mini - per 5 strumenti - Blu		13	2801-L1	Portaimpronta forati in acciaio inox		J12	2802-U4	Portaimpronta non forati in acciaio inox		J32	J6			
2772-1A	Cassette portastrumenti in acciaio inox - mini - per 5 strumenti - Arancione		13	2801-L2	Portaimpronta forati in acciaio inox		J12	2802-U4A	Portaimpronta non forati in acciaio inox - ANATOMIC		J34	2804-L4	Portaimpronta forati in acciaio inox - PERMA-LOCK		J4
2772-1R	Cassette portastrumenti in acciaio inox - mini - per 5 strumenti - Rosso		13	2801-L2D	Portaimpronta forati in acciaio inox		J12	2802-U5	Portaimpronta non forati in acciaio inox		J32	2804-L4D	Portaimpronta forati in acciaio inox - PERMA-LOCK		J4
2772-1V	Cassette portastrumenti in acciaio inox - mini - per 5 strumenti - Verde		13	2801-L2S	Portaimpronta forati in acciaio inox		J12	2802-U5A	Portaimpronta non forati in acciaio inox - ANATOMIC		J34	2804-L4S	Portaimpronta forati in acciaio inox - PERMA-LOCK		J4
2772-G	Rastrelliera - per 10 posti - Blu - silicone		13	2801-L3	Portaimpronta forati in acciaio inox		J12	2802-U6	Portaimpronta non forati in acciaio inox		J32	2804-L5	Portaimpronta forati in acciaio inox - PERMA-LOCK		J4
2772-GA	Rastrelliera - per 10 posti - Arancione - silicone		13	2801-L4	Portaimpronta forati in acciaio inox		J12	2802-U6A	Portaimpronta non forati in acciaio inox - ANATOMIC		J34	J6			
2772-GR	Rastrelliera - per 10 posti - Rosso - silicone		13	2801-L4D	Portaimpronta forati in acciaio inox		J12	2803-L1	Portaimpronta non forati in acciaio inox - NEW SUPER		J20	2804-L6	Portaimpronta forati in acciaio inox - PERMA-LOCK		J4
2772-GV	Rastrelliera - per 10 posti - Verde - silicone		13	2801-L4S	Portaimpronta forati in acciaio inox		J12	2803-L2	Portaimpronta non forati in acciaio inox - NEW SUPER		J20	J6			
2773-G	Rastrelliera - per 5 posti - Blu - silicone		13	2801-L5	Portaimpronta forati in acciaio inox		J12	2803-L3	Portaimpronta non forati in acciaio inox - NEW SUPER		J20	2804-L6D	Portaimpronta forati in acciaio inox - PERMA-LOCK		J4
2773-GA	Rastrelliera - per 5 posti - Arancione - silicone		13	2801-L6	Portaimpronta forati in acciaio inox		J12	2803-L4	Portaimpronta non forati in acciaio inox - NEW SUPER		J20	2804-L6S	Portaimpronta forati in acciaio inox - PERMA-LOCK		J4
2773-GR	Rastrelliera - per 5 posti - Rosso - silicone		13	2801-L6D	Portaimpronta forati in acciaio inox		J12	2803-L5	Portaimpronta non forati in acciaio inox - NEW SUPER		J20	2804S-L1	Portaimpronta forati in acciaio inox - PERMA-LOCK high grip		J8
2773-GV	Rastrelliera - per 5 posti - Verde - silicone		13	2801-L6S	Portaimpronta forati in acciaio inox		J12	2803S-L1	Portaimpronta non forati in acciaio inox - NEW SUPER high grip		J30	2804S-L2	Portaimpronta forati in acciaio inox - PERMA-LOCK high grip		J8
2774	Parti di ricambio per portastrumenti - pomelli completi di rondelle		13	2801-U1	Portaimpronta forati in acciaio inox		J12	2803S-L2	Portaimpronta non forati in acciaio inox - NEW SUPER high grip		J30	2804S-L3	Portaimpronta forati in acciaio inox - PERMA-LOCK high grip		J8
2775	Clips per portastrumenti per forbici		13	2801-U1A	Portaimpronta forati in acciaio inox - ANATOMIC		J14	2803S-L3	Portaimpronta non forati in acciaio inox - NEW SUPER high grip		J30	2804S-L4	Portaimpronta forati in acciaio inox - PERMA-LOCK high grip		J8
2780-1A	Cassette portastrumenti in acciaio inox - implantologia - h. 60 mm		12	2801-U2	Portaimpronta forati in acciaio inox		J12	2803S-L4	Portaimpronta non forati in acciaio inox - NEW SUPER high grip		J30	2804S-L5	Portaimpronta forati in acciaio inox - PERMA-LOCK high grip		J8
2800-L1	Portaimpronta forati in alluminio		J36	2801-U2A	Portaimpronta forati in acciaio inox - ANATOMIC		J14	2803S-L5	Portaimpronta non forati in acciaio inox - NEW SUPER high grip		J30	2804S-U1	Portaimpronta forati in acciaio inox - PERMA-LOCK high grip		J8
2800-L2	Portaimpronta forati in alluminio		J36	2801-U3	Portaimpronta forati in acciaio inox		J12	2803S-U1	Portaimpronta non forati in acciaio inox - NEW SUPER high grip		J30	2804S-U2	Portaimpronta forati in acciaio inox - PERMA-LOCK high grip		J8
2800-L2D	Portaimpronta forati in alluminio		J36	2801-U3A	Portaimpronta forati in acciaio inox - ANATOMIC		J14	2803S-U2	Portaimpronta non forati in acciaio inox - NEW SUPER high grip		J30	2804S-U3	Portaimpronta forati in acciaio inox - PERMA-LOCK high grip		J8
2800-L2S	Portaimpronta forati in alluminio		J36	2801-U4	Portaimpronta forati in acciaio inox		J12	2803S-U3	Portaimpronta non forati in acciaio inox - NEW SUPER high grip		J30	2804-U1	Portaimpronta forati in acciaio inox - PERMA-LOCK		J4
2800-L3	Portaimpronta forati in alluminio		J36	2801-U4A	Portaimpronta forati in acciaio inox - ANATOMIC		J14	2803S-U4	Portaimpronta non forati in acciaio inox - NEW SUPER high grip		J30	2804-U1A	Portaimpronta forati in acciaio inox - PERMA-LOCK anatomic		J6
2800-L4	Portaimpronta forati in alluminio		J36	2801-U4S	Portaimpronta forati in acciaio inox - ANATOMIC		J14	2803S-U5	Portaimpronta non forati in acciaio inox - NEW SUPER high grip		J30	2804-U1P	Portaimpronta forati in acciaio inox - PERMA-LOCK		J4
2800-L4D	Portaimpronta forati in alluminio		J36	2802-L1	Portaimpronta non forati in acciaio inox		J32	2803-U1	Portaimpronta non forati in acciaio inox - NEW SUPER		J20	2804-U2	Portaimpronta forati in acciaio inox - PERMA-LOCK		J4
2800-L4S	Portaimpronta forati in alluminio		J36	2802-L2	Portaimpronta non forati in acciaio inox		J32	2803-U2	Portaimpronta non forati in acciaio inox - NEW SUPER		J20				
				2802-L2D	Portaimpronta non forati in acciaio inox		J32								
				2802-L2S	Portaimpronta non forati in acciaio inox		J32								
				2802-L3	Portaimpronta non forati in acciaio inox		J32								
				2802-L4	Portaimpronta non forati in acciaio inox		J32								
				2802-L4D	Portaimpronta non forati in acciaio inox		J32								
				2802-L4S	Portaimpronta non forati in acciaio inox		J32								
				2802-L5	Portaimpronta non forati in acciaio inox		J32								
							J34								

codice	descrizione	manico	pagina	codice	descrizione	manico	pagina	codice	descrizione	manico	pagina	codice	descrizione	manico	pagina
2851-13	Portaimpronta in policarbonato per edentuli		J43	2901E-VT15	Cannule multi-color		A4	3051-212	Uncini per diga - con alette		F4	3251E-C/9	Mantelline		A19
2852-12	Portaimpronta in policarbonato		J42	2902-L	Cannule chirurgiche in acciaio inox		C44	3051-26	Uncini per diga - senza alette		F6	3251E-D/9	Mantelline		A19
2853E-1	Portaimpronta monouso in plastica		A23	2902-M	Cannule chirurgiche in acciaio inox		C44	3051-29	Uncini per diga - con alette		F5	3251E-G/9	Mantelline		A19
2853E-1DS	Portaimpronta monouso in plastica		A23	2902-S	Cannule chirurgiche in acciaio inox		C44	3051-51	Uncini per diga - senza alette		F6	3251E-L/9	Mantelline		A19
2853E-2	Portaimpronta monouso in plastica		A23	2903E-BA155	Cannule con cappuccio morbido - Total-Comfort		A3	3052-0	Uncini per diga - con alette		F4	3251E-LI/9	Mantelline		A19
2853E-2DS	Portaimpronta monouso in plastica		A23	2903E-BAS155	Cannule con cappuccio morbido - Total-Comfort		A3	3052-00	Uncini per diga - con alette		F4	3251E-O/9	Mantelline		A19
2853E-3	Portaimpronta monouso in plastica		A23	2903E-BT155	Cannule con cappuccio morbido - Total-Comfort		A3	3052-1	Uncini per diga - con alette		F5	3251E-V/9	Mantelline		A19
2853E-4	Portaimpronta monouso in plastica		A23	2903E-BT155	Cannule con cappuccio morbido - Total-Comfort		A3	3052-12A	Uncini per diga - dentellato con alette		F7	3252E-B/9	Mantelline		A19
2880-FR	Portaimpronta forati in alluminio per implantologia - fresa in carburo di tungsteno		J38	2903E-BT155	Cannule con cappuccio morbido - Total-Comfort		A3	3052-13A	Uncini per diga - dentellato con alette		F7	3252E-C/9	Mantelline		A19
2880-L1	Portaimpronta forati in alluminio per implantologia		J38	2903E-BTS155	Cannule con cappuccio morbido - Total-Comfort		A3	3052-14	Uncini per diga - con alette		F6	3252E-D/9	Mantelline		A19
2880-L2	Portaimpronta forati in alluminio per implantologia		J38	2903E-TA155	Cannule con cappuccio morbido - Total-Comfort		A3	3052-14A	Uncini per diga - con alette		F7	3252E-G/9	Mantelline		A19
2880-L3	Portaimpronta forati in alluminio per implantologia		J38	2903E-TAS155	Cannule con cappuccio morbido - Total-Comfort		A3	3052-14A	Uncini per diga - con alette		F7	3252E-L/9	Mantelline		A19
2880-L4	Portaimpronta forati in alluminio per implantologia		J38	2903E-TT155	Cannule con cappuccio morbido - Total-Comfort		A3	3052-14T	Uncini per diga - dentellato con alette		F6	3252E-LI/9	Mantelline		A19
2880-L5	Portaimpronta forati in alluminio per implantologia		J38	2903E-TT155	Cannule con cappuccio morbido - Total-Comfort		A3	3052-1T	Uncini per diga - dentellato con alette		F5	3252E-O/9	Mantelline		A19
2880-L6	Portaimpronta forati in alluminio per implantologia		J38	2903E-TT155	Cannule con cappuccio morbido - Total-Comfort		A3	3052-2	Uncini per diga - con alette		F5	3252E-V/9	Mantelline		A19
2880-U1	Portaimpronta forati in alluminio per implantologia		J38	2903E-TT155	Cannule con cappuccio morbido - Total-Comfort		A3	3052-2A	Uncini per diga - con alette		F5	3301E-L	Guanti per esame		A15
2880-U2	Portaimpronta forati in alluminio per implantologia		J38	2904-10	Cannule chirurgiche in acciaio inox - Frazier		C44	3052-2AT	Uncini per diga - dentellato con alette		F5	3301E-M	Guanti per esame		A15
2880-U3	Portaimpronta forati in alluminio per implantologia		J38	2904-12	Cannule chirurgiche in acciaio inox - Frazier		C44	3052-2T	Uncini per diga - dentellato con alette		F5	3301E-S	Guanti per esame		A15
2880-U4	Portaimpronta forati in alluminio per implantologia		J38	2904-6	Cannule chirurgiche in acciaio inox - Frazier		C44	3052-3	Uncini per diga - con alette		F5	3301E-XS	Guanti per esame		A15
2880-U5	Portaimpronta forati in alluminio per implantologia		J38	2904-8	Cannule chirurgiche in acciaio inox - Frazier		C44	3052-4	Uncini per diga - con alette		F6	3303E-L	Guanti per esame		A15
2880-U6	Portaimpronta forati in alluminio per implantologia		J38	2905-155	Cannule chirurgiche		C44	3052-7	Uncini per diga - con alette		F6	3303E-M	Guanti per esame		A15
2900E-AT13	Cannule multi-color		A4	2905-AD	Cannule chirurgiche		C44	3052-8	Uncini per diga - con alette		F7	3303E-S	Guanti per esame		A15
2900E-AT15	Cannule multi-color		A4	2908E-AT13	Cannule al profumo di menta - AsaFresh		A2	3052-8A	Uncini per diga - con alette		F6	3305-L	Guanti per esame		A15
2900E-ATS15	Cannule multi-color		A5	2908E-AT15	Cannule al profumo di menta - AsaFresh		A2	3052-9	Uncini per diga - con alette		F4	3305-S	Guanti per esame		A15
2900E-BBS15	Cannule multi-color		A5	2908E-BBS15	Cannule al profumo di menta - AsaFresh		A2	3052-9T	Uncini per diga - con alette		F4	3305-XS	Guanti per esame		A15
2900E-BT13	Cannule multi-color		A4	2908E-TCS15	Cannule al profumo di menta - AsaFresh		A2	3052-W0	Uncini per diga - senza alette		F5	3309E-L	Guanti per esame		A16
2900E-BT15	Cannule multi-color		A4	2908E-TT13	Cannule al profumo di menta - AsaFresh		A2	3052-W1	Uncini per diga - senza alette		F5	3309E-M	Guanti per esame		A16
2900E-GT13	Cannule multi-color		A4	2908E-TT15	Cannule al profumo di menta - AsaFresh		A2	3052-W14	Uncini per diga - senza alette		F6	3309E-S	Guanti per esame		A16
2900E-GT15	Cannule multi-color		A4	2908E-TT15	Cannule al profumo di menta - AsaFresh		A2	3052-W14A	Uncini per diga - senza alette		F7	3309E-XS	Guanti per esame		A16
2900E-LT13	Cannule multi-color		A4	2908E-TT15	Cannule al profumo di menta - AsaFresh		A2	3052-W2	Uncini per diga - senza alette		F5	3310E-L	Guanti per esame		A16
2900E-LT15	Cannule multi-color		A4	2908E-TT15	Cannule al profumo di menta - AsaFresh		A2	3052-W2A	Uncini per diga - senza alette		F5	3310E-M	Guanti per esame		A16
2900E-OT13	Cannule multi-color		A5	2908E-TT15	Cannule al profumo di menta - AsaFresh		A2	3052-W3	Uncini per diga - senza alette		F6	3310E-S	Guanti per esame		A16
2900E-OT15	Cannule multi-color		A5	2908E-TT15	Cannule al profumo di menta - AsaFresh		A2	3052-W4	Uncini per diga - senza alette		F7	3310E-XS	Guanti per esame		A16
2900E-RT13	Cannule multi-color		A5	2908E-TT15	Cannule al profumo di menta - AsaFresh		A2	3052-W7	Uncini per diga - senza alette		F6	3311E-L	Guanti per esame		A16
2900E-RT15	Cannule multi-color		A5	2908E-TT15	Cannule al profumo di menta - AsaFresh		A2	3052-W8	Uncini per diga - senza alette		F7	3311E-M	Guanti per esame		A16
2900E-TCS15	Cannule multi-color		A5	2908E-TT15	Cannule al profumo di menta - AsaFresh		A2	3052-W8A	Uncini per diga - senza alette		F6	3311E-S	Guanti per esame		A16
2900E-TT13	Cannule multi-color		A4	2908E-TT15	Cannule al profumo di menta - AsaFresh		A2	3070-5	Porta matrici - Ivory		F46	3311E-XS	Guanti per esame		A16
2900E-TT15	Cannule multi-color		A4	2908E-TT15	Cannule al profumo di menta - AsaFresh		A2	3070-6	Porta matrici - Ivory		F46	3312E-L	Guanti per esame		A16
2900E-TTS15	Cannule multi-color		A5	2908E-TT15	Cannule al profumo di menta - AsaFresh		A2	3070-7	Porta matrici - Ivory		F46	3312E-M	Guanti per esame		A16
2900E-VT13	Cannule multi-color		A4	2908E-TT15	Cannule al profumo di menta - AsaFresh		A2	3071	Porta matrici - Ivory		F46	3312E-S	Guanti per esame		A16
2900E-VT15	Cannule multi-color		A4	2908E-TT15	Cannule al profumo di menta - AsaFresh		A2	3072	Porta matrici - Didner		F46	3312E-XS	Guanti per esame		A16
2900E-VTS15	Cannule multi-color		A5	2908E-TT15	Cannule al profumo di menta - AsaFresh		A2	3073-1	Porta matrici - Tofflemire universal		F46	3313E-L	Guanti per esame		A17
2900E-ZT13	Cannule multi-color		A5	2908E-TT15	Cannule al profumo di menta - AsaFresh		A2	3073-2	Porta matrici - Tofflemire Junior		F46	3313E-M	Guanti per esame		A17
2900E-ZT15	Cannule multi-color		A5	2908E-TT15	Cannule al profumo di menta - AsaFresh		A2	3073-3	Porta matrici - Tofflemire Senior		F46	3313E-S	Guanti per esame		A17
2901E-AT13	Cannule multi-color		A4	3030	Pinze per uncini - Ivory lightweight		F9	3081	Matrici - Tofflemire		F47	3313E-XS	Guanti per esame		A17
2901E-AT15	Cannule multi-color		A4	3031	Pinze per uncini - Brewer		F9	3081-1	Matrici - Tofflemire		F47	3314E-L	Guanti per esame		A17
2901E-TT13	Cannule multi-color		A4	3032	Pinze per forare la diga - Ainsworth		F8	3081-2	Matrici - Tofflemire		F47	3314E-M	Guanti per esame		A17
2901E-TT15	Cannule multi-color		A4	3033	Pinze per forare la diga - Ivory		F8	3081-3	Matrici - Tofflemire		F47	3314E-S	Guanti per esame		A17
2901E-VT13	Cannule multi-color		A4	3034	Pinze per uncini - Stoke		F9	3082-5	Bande per porta matrici		F47	3314E-XS	Guanti per esame		A17
2901E-VT15	Cannule multi-color		A4	3040-1	Strumenti per diga		F9	3082-6	Bande per porta matrici		F47	3315E-L	Guanti per esame		A17
2901E-VTS15	Cannule multi-color		A5	3041-1	Strumenti per diga		F9	3082-7	Bande per porta matrici		F47	3315E-M	Guanti per esame		A17
2901E-AT13	Cannule multi-color		A4	3045	Strumenti per diga - diga in lattice confezionata in sottovuoto conf. 36 pz		F8	3101	Accessori - lampada ad alcool		I19	3315E-S	Guanti per esame		A17
2901E-AT15	Cannule multi-color		A4	3050-60	Uncini per diga - senza alette		F5	3101-1	Accessori - stoppino		I19	3316E-L	Guanti per esame		A17
2901E-TT13	Cannule multi-color		A4	3051-202	Uncini per diga - con alette		F7	3200	Salviette - AsaRainbow - catenella reggi salviette		A7	3316E-M	Guanti per esame		A17
2901E-TT15	Cannule multi-color		A4	3051-205	Uncini per diga - senza alette		F7	3251E-B/9	Mantelline		A19	3316E-S	Guanti per esame		A17
2901E-VT13	Cannule multi-color		A4	3051-210	Uncini per diga - con alette		F4					3400-300	Rotoli per sterilizzare		A13
												3403-140	Buste per sterilizzare		A18
												3403-75	Buste per sterilizzare		A18
												3403-90	Buste per sterilizzare		A18
												3400E-55	Rotoli per sterilizzare		A13

codice	descrizione	manico	pagina
3400E-75	Rotoli per sterilizzare		A13
3400E-100	Rotoli per sterilizzare		A13
3400E-150	Rotoli per sterilizzare		A13
3400E-200	Rotoli per sterilizzare		A13
3400E-250	Rotoli per sterilizzare		A13
3450E-B	Mascherine chirurgiche		A14
3450E-C	Mascherine chirurgiche		A14
3450E-HC	Mascherine chirurgiche		A14
3450E-HR	Mascherine chirurgiche		A14
3450E-R	Mascherine chirurgiche		A14
3450E-V	Mascherine chirurgiche		A14
3510-B	Salviette - AsaRainbow		A6
3510-BX	Salviette - AsaRainbow		A6
3510-C	Salviette - AsaRainbow		A6
3510-D	Salviette - AsaRainbow		A6
3510-G	Salviette - AsaRainbow		A6
3510-L	Salviette - AsaRainbow		A6
3510-LI	Salviette - AsaRainbow		A6
3510-NI	Salviette - AsaRainbow		A6
3510-O	Salviette - AsaRainbow		A6
3510-P	Salviette - AsaRainbow		A6
3510-PE	Salviette - AsaRainbow		A6
3510-V	Salviette - AsaRainbow		A6
3511-B	Salviette - AsaRainbow		A6
3511-BX	Salviette - AsaRainbow		A6
3511-C	Salviette - AsaRainbow		A6
3511-D	Salviette - AsaRainbow		A6
3511-G	Salviette - AsaRainbow		A6
3511-L	Salviette - AsaRainbow		A7
3511-LI	Salviette - AsaRainbow		A7
3511-N	Salviette - AsaRainbow		A7
3511-O	Salviette - AsaRainbow		A7
3511-P	Salviette - AsaRainbow		A7
3511-PE	Salviette - AsaRainbow		A7
3511-V	Salviette - AsaRainbow		A7
3520-1	Rulli salivari di cotone		A12
3520-2	Rulli salivari di cotone		A12
3520-3	Rulli salivari di cotone		A12
3600E	Chiaccio sintetico		A22
3700-B	Dappen dishes		A9
3700-C	Dappen dishes		A9
3700-G	Dappen dishes		A9
3700-MX	Dappen dishes		A8
3700-N	Dappen dishes		A9
3700-R	Dappen dishes		A9
3710	Siringhe in plastica		A20
3818-B	Bicchieri		A20
5000-1	Articolatori - parti di ricambio - piastrina di montaggio		K6 K9
5000-1M	Articolatori - parti di ricambio - piastrina magnetica completa		K7 K9
5000-2	Articolatori - parti di ricambio - piano di occlusione		K9
5000-3	Articolatori - parti di ricambio - asta incisale		K9
5000-4	Articolatori - parti di ricambio - piano incisale (10°)		K9
5000-4N	Articolatori - parti di ricambio - piano incisale (10°)		K9
5000-5	Articolatori - parti di ricambio - pomello metallico di serraggio		K9

codice	descrizione	manico	pagina
5000-7	Articolatori - parti di ricambio - vite per regolazione molla movimenti laterali		K9
5000-8	Articolatori - parti di ricambio - indicatore incisale		K9
5000-12	Articolatori - parti di ricambio - molla per movimenti laterali		K9
5000-13	Articolatori - parti di ricambio - cilindro per movimenti laterali		K9
5000-18	Articolatori - parti di ricambio - viti M5 per fissaggio base incisale		K9
5000-24	Articolatori - parti di ricambio - piedini in gomma		K7 K9
5000-25	Articolatori - parti di ricambio - contromagneti per gesso		K7 K9
5000-26	Articolatori - parti di ricambio - magneti		K7 K9
5000-30	Articolatori - parti di ricambio - camicia porta magnete		K7 K9
5001	Articolatori - occlusore		K6
5002	Articolatori a valori medi		K6
5010-10	Articolatori - parti di ricambio - asta antiribaltamento		K9
5011-4	Articolatori - parti di ricambio - piano incisale (0°)		K9
5011-6	Articolatori - parti di ricambio - vite di serraggio		K9
5011-9	Articolatori - parti di ricambio - asta movimento condilare		K9
5011-11	Articolatori - parti di ricambio - cappuccio in gomma		K9
5011-16	Articolatori - parti di ricambio - piano inclinato di contrasto		K9
5011-17	Articolatori - parti di ricambio - asse cerniera		K9
5011-18	Articolatori - parti di ricambio - rondella di rasamento asse cerniera		K9
5011-19	Articolatori - parti di ricambio - molla interna asse cerniera		K9
5011-20	Articolatori - parti di ricambio - porta asta posteriore		K9
5011-21	Articolatori - parti di ricambio - asta posteriore		K9
5011-22	Articolatori - parti di ricambio - vite micrometrica di registrazione		K9
5011-23	Articolatori - parti di ricambio - controvite		K9
5020	Easy Bow - set completo		K10
5021	Easy Bow - arco facciale		K10
5022	Easy Bow - porta forchetta		K10
5023-1	Easy Bow - forchetta		K10
5023-2	Easy Bow - forchetta		K10
5023-3	Easy Bow - forchetta		K10
5024	Easy Bow - tavolo di trasferimento		K10
5030	Articolatori a valori medi		K4
5030-2	Articolatori - parti di ricambio - piano di occlusione		K9
5030-3	Articolatori - parti di ricambio - asta incisale		K9
5030-6	Articolatori - parti di ricambio - vite di serraggio per distanziatore		K9
5030-9	Articolatori - parti di ricambio - asta movimento condilare		K9

codice	descrizione	manico	pagina
5030-10	Articolatori - parti di ricambio - asta antiribaltamento		K9
5030-29	Articolatori - parti di ricambio - distanziatore		K7 K9
5032	Articolatori a valori medi		K5
5032-16	Articolatori - parti di ricambio - piano inclinato di contrasto		K9
5032-17	Articolatori - parti di ricambio - asse cerniera		K9
5032-21	Articolatori - parti di ricambio - asta posteriore		K9
5032-22	Articolatori - parti di ricambio - vite micrometrica di registrazione		K9
5032-23	Articolatori - parti di ricambio - contro vite		K9
5033	Articolatori - parti di ricambio - taratore		K9
5050	Articolatori a valori medi		K2
5050Plus	Articolatori a valori medi		K3
5050-2	Articolatori - parti di ricambio - supporto per piano occlusale e calotta		K9
5050-3	Articolatori - parti di ricambio - asta incisale		K9
5050-4	Articolatori - parti di ricambio - vite zigrinata per piano occlusale e calotta		K9
5050-6	Articolatori - parti di ricambio - vite di serraggio		K9
5050-8	Articolatori - parti di ricambio - indicatore incisale		K9
5050-17	Articolatori - parti di ricambio - asse cerniera		K9
5050-20	Articolatori - parti di ricambio - porta asta posteriore		K9
5050-21	Articolatori - parti di ricambio - asta posteriore		K9
5050-24	Articolatori - parti di ricambio - piedini in gomma		K9
5051	Articolatori - parti di ricambio - piano di occlusione		K9
5052	Articolatori - parti di ricambio - calotta		K9
5053	Articolatori - parti di ricambio - kit asta magnetica		K9
5053-1	Articolatori - parti di ricambio - asta con magneti incollati		K9
5053-2	Articolatori - parti di ricambio - ghiera per asta		K9
5053-3	Articolatori - parti di ricambio - piano per asta magnetica		K9
5054	Articolatori - parti di ricambio - piano occlusale completo (5050-4 + 5051 + 5050-2)		K9
5100	Strumenti per modellare amalgama/cera - Hylin		K14
5100-1	Strumenti per modellare amalgama/cera con manico millimetrato - Hylin		K14
5101	Strumenti per modellare amalgama/cera - Hylin-Le Cron		K14
5102	Strumenti per modellare amalgama/cera - Hylin		K14

codice	descrizione	manico	pagina
5103	Strumenti per modellare amalgama/cera - Hylin		K14
5104	Strumenti per modellare amalgama/cera		K14
5105	Strumenti per modellare amalgama/cera - Le Cron		K15
5106	Strumenti per modellare amalgama/cera - Le Cron		K15
5107	Strumenti per modellare amalgama/cera - Le Cron		K15
5108	Strumenti per modellare amalgama/cera - Le Cron		K15
5109	Strumenti per modellare amalgama/cera - Zahle		K15
5110	Strumenti per modellare amalgama/cera - Zahle		K15
5111	Strumenti per modellare amalgama/cera - Zahle		K16
5112-1	Strumenti per modellare amalgama/cera - P.K. Thomas	Asa60	K17
5112-1AL	Strumenti per modellare amalgama/cera - P.K. Thomas	Alu80	K17
5112-2	Strumenti per modellare amalgama/cera - P.K. Thomas	Asa60	K17
5112-2AL	Strumenti per modellare amalgama/cera - P.K. Thomas	Alu80	K17
5112-3	Strumenti per modellare amalgama/cera - Asa Com 1/1B - P.K. Thomas	Asa60	F48 K17
5112-3AL	Strumenti per modellare amalgama/cera - P.K. Thomas	Alu80	K17
5112-4	Strumenti per modellare amalgama/cera - Asa Com 13/13B - P.K. Thomas	Asa60	F50 K17
5112-4AL	Strumenti per modellare amalgama/cera - P.K. Thomas	Alu80	K17
5112-5	Strumenti per modellare amalgama/cera - P.K. Thomas	Asa60	K17
5112-5AL	Strumenti per modellare amalgama/cera - P.K. Thomas	Alu80	K17
5113	Strumenti per modellare amalgama/cera - Critman		K16
5114	Strumenti per modellare amalgama/cera - Beale		K16
5114-1	Scollaperiostio ed Elevatori - Beale	Octagonal	E22 G16
5115	Strumenti per modellare amalgama/cera - Roach		K16
5116	Strumenti per modellare amalgama/cera - Vehe		K16
5150	Strumenti per ceramica e resine di rivestimento		K21
5150-1	Strumenti per ceramica e resine di rivestimento	Alu80	K21
5150-2	Strumenti per ceramica e resine di rivestimento	Alu80	K21
5150-3	Strumenti per ceramica e resine di rivestimento	Alu80	K21
5151	Strumenti per ceramica e resine di rivestimento		K21
5151-1	Strumenti per ceramica e resine di rivestimento - Greenstein	Alu80	K21
5151-2	Strumenti per ceramica e resine di rivestimento - Greenstein	Alu80	K21

codice	descrizione	manico	pagina
5151-3	Strumenti per ceramica e resine di rivestimento · Greenstein	Alu80	K21
5153-1	Strumenti per composito · Asa Com 7/7B	Asa60	F49
5155-1	Strumenti per ceramica e resine di rivestimento		K21
5155-2	Strumenti per ceramica e resine di rivestimento		K21
5155-3	Strumenti per ceramica e resine di rivestimento		K21
5156-1	Strumenti per ceramica e resine di rivestimento		K21
5156-2	Strumenti per ceramica e resine di rivestimento		K21
5156-3	Strumenti per ceramica e resine di rivestimento		K21
5160-1	Strumenti per ceramica e resine di rivestimento (punte)		K18
5160-2	Strumenti per ceramica e resine di rivestimento (punte)		K18
5160-3	Strumenti per ceramica e resine di rivestimento (punte)		K18
5200-1	Coltelli per cera · Fahnenstock		K22
5200-2	Coltelli per cera · Fahnenstock		K22
5201-1	Coltelli per cera · Lessmann		K22
5201-2	Coltelli per cera · Lessmann		K22
5202-1	Coltelli per cera		K22
5202-2	Coltelli per cera		K22
5300-1	Coltelli per gessi		K23
5300-2	Coltelli per gessi · Gritman		K23
5300-3	Coltelli per gessi		K23
5300-4	Coltelli per gessi		K23
5400-1	Spatole rigide per alginato, gesso ed elastomeri		K24
5400-2	Spatole rigide per alginato, gesso ed elastomeri		K24
5400-3	Spatole rigide per alginato, gesso ed elastomeri		K24
5400-4	Spatole flessibili per alginato, gesso ed elastomeri		K25
5400-5	Spatole flessibili per alginato, gesso ed elastomeri		K25
5400-6	Spatole flessibili per alginato, gesso ed elastomeri		K25
5400-7	Spatole flessibili per alginato, gesso ed elastomeri		K25
5400-8	Spatole rigide per alginato, gesso ed elastomeri		K24
5400-9	Spatole rigide per alginato, gesso ed elastomeri		K24
5401-B	Spatole per alginato e gesso		K26
5401-C	Spatole per alginato e gesso		K26
5401-F	Spatole per alginato e gesso		K26
5401-G	Spatole per alginato e gesso		K26
5401-R	Spatole per alginato e gesso		K26
5401-V	Spatole per alginato e gesso		K26
5500-10	Tazze per alginato e gesso		K26
5500-12	Tazze per alginato e gesso		K26
5500-14	Tazze per alginato e gesso		K26
5500-16	Tazze per alginato e gesso		K26
5501-10	Tazze per alginato e gesso		K26
5501-12	Tazze per alginato e gesso		K26
5501-14	Tazze per alginato e gesso		K26
5501-16	Tazze per alginato e gesso		K26

codice	descrizione	manico	pagina
5600-1	Forbici per corone · rette, una punta dentata		F45 K28
5600-2	Forbici per corone · rette, una punta dentata		F45 K28
5601-1	Forbici per corone · rette		F45 K28
5601-2	Forbici per corone · curve		F45 K28
5700	Forbici universali · rette, una punta dentata · universal		F45 K28
5700TC	Forbici universali · TC universal		F45
5800	Pinze per piegare fili · Nance		H12
5801-1	Pinze per piegare fili · Delphin universal		H10
5801-3	Pinze per piegare fili · universal		H10
5802	Pinze per piegare fili · Waldsachs		H11
5806	Pinze per piegare fili · pinze tonde e concave		H12
5809-1	Pinze per piegare fili · Tweed		H12
5809-2	Pinze per piegare fili · Tweed		H13
5809-3	Pinze per piegare fili · Tweed		H15
5812	Pinze per piegare fili · Reynolds		H16
5818	Pinze per piegare fili		H16
5819	Pinze di utilità · Weingart		H29
5821-1	Pinze per piegare fili · De La Rosa		H18
5821-2	Pinze per piegare fili · De La Rosa		H18
5824-1	Pinze di utilità		H31
5825	Pinze di utilità		H32
5826-1	Pinze di utilità		H30
5826-2	Pinze di utilità		H30
5826-CR1	Pinze di utilità		H30
5826-CR2	Pinze di utilità		H30
5828-1	Pinze di utilità		H30
5828-2	Pinze di utilità		H31
5832	Tronchesi		H7
5832-1TC	Tronchesi		H7
5833	Tronchesi		H8
5833-1TC	Tronchesi		H8
5836	Tronchesi		H9
5836-1TC	Tronchesi		H9
5837	Tronchesi		H9
5838	Pinze per piegare fili · tagliente · Angle		H19
5860-1	Pinze per piegare fili · Mc Kellops		H18
5861	Pinze per piegare fili · Johnson		H20
5862	Pinze per piegare fili · Nance		H15
5863	Pinze per piegare fili · Young		H14
5864	Pinze per piegare fili		H18
5865	Pinze per piegare fili		H19
5866	Pinze per piegare fili · Angle		H19
5867-1	Pinze per piegare fili · Adams		H20
5867-2	Pinze per piegare fili · Adams		H20
5868	Pinze per piegare fili		H19
5869-1	Pinze per piegare fili · mini · Aderer		H21
5869-2	Pinze per piegare fili · standard · Aderer		H21
5870	Pinze per piegare fili · Tweed		H14
5871	Pinze per piegare fili		H24
5872-1	Pinze per piegare fili · Tweed (Angle)		H15
5874-1	Pinze per piegare fili · pinze universali · How		H23
5874-2	Pinze per piegare fili · curve · How		H23
5875-1	Pinze per piegare fili		H24

codice	descrizione	manico	pagina
5875-2	Pinze per piegare fili		H24
5876-1	Pinze per piegare fili		H24
5876-2	Pinze per piegare fili		H24
5880-1	Tronchesi · tagli filo <= 0.9 mm		H8
5880-2	Tronchesi · tagli filo <= 1.5 mm		H8
5880-3TC	Tronchesi · tagli filo <= 1.2 mm		H9
5900	Cesoia taglia gesso · Asa Special Inox		K31
6000	Martelli		K31
6001	Martelli		K31
6002	Martelli		K31
6200	Seghetto		K33
6201-1	Lame per seghetto · per gesso		K33
6201-2	Lame per seghetto · per metallo		K33
6300	Sega per modelli		K33
6301-1	Lame per seghetto · per modelli		K33
6301-2	Lame per seghetto · per modelli		K33
6301-3	Lame per seghetto · per modelli		K33
6400-1	Pinzette per laboratorio		K19
6400-2	Pinzette per laboratorio		K19
6600-2	Pinze per cilindri e muffole		K32
6600-4	Pinze per cilindri e muffole		K32
6600-5	Pinze per cilindri e muffole		K32
6900E-A	Contenitori per protesi/ortodontici · Blu		H37
6900E-A	Contenitori per protesi/ortodontici · Blu		H37
6900E-B	Contenitori per protesi/ortodontici · Bianco		H37
6900E-B	Contenitori per protesi/ortodontici · Bianco		H37
6900E-C	Contenitori per protesi/ortodontici · Celeste		H37
6900E-C	Contenitori per protesi/ortodontici · Celeste		H37
7000-6	Pennelli per ceramica		K20
7000-8	Pennelli per ceramica		K20
7001-0	Pennelli per ceramica		K20
7001-00	Pennelli per ceramica		K20
7001-1	Pennelli per ceramica		K20
7001-3	Pennelli per ceramica		K20
7002-4	Pennelli per ceramica		K20
7002-6	Pennelli per ceramica		K20
7002-8	Pennelli per ceramica		K20
8000	Lab Set per Odontotecnica		K34
8001	Lubrificanti protettivi per strumenti · Steril Oil		G33
8002	Lubrificanti protettivi per strumenti · Steril Oil		D71 I12
8010	Lubrificanti protettivi per strumenti · silicone		D71 I12
8020	AsaClean · soluzione PH neutra per facilitare la rimozione di alginato		J40
8801-1	Pinze per piegare fili · universali · Delphin		H10
8801-2	Pinze per piegare fili · universali		H10
8802	Pinze per piegare fili · Waldsachs		H11
8803	Pinze per piegare fili		H26
8804-1	Pinze per piegare fili · Tweed		H14
8804-2	Pinze per piegare fili · Tweed		H13
8804-2P	Pinze per piegare fili		H13
8804-3P	Pinze per piegare fili		H13
8805	Pinze per piegare fili · Reynolds		H16
8806	Pinze per piegare fili		H26

codice	descrizione	manico	pagina
8807-1	Pinze per piegare fili		H17
8807-2	Pinze per piegare fili		H17
8807-3	Pinze per piegare fili		H16
8808-1	Pinze di utilità · Weingart		H29
8808-2	Pinze di utilità · Weingart		H29
8809	Pinze di utilità		H31
8810	Pinze di utilità		H32
8811-1	Pinze di utilità		H30
8811-1P	Pinze di utilità		H30
8811-2	Pinze di utilità		H31
8812-1TC	Tronchesi		H7
8812-2TC	Tronchesi		H4
8813-1TC	Tronchesi		H4
8814-1TC	Tronchesi		H5
8815	Pinze per piegare fili · Johnson		H20
8816	Pinze per piegare fili · Nance		H11
8817	Pinze per piegare fili · Young		H14
8818	Pinze per piegare fili		H22
8819	Pinze per piegare fili · Adams		H20
8820-1	Pinze per piegare fili · Aderer		H21
8820-2	Pinze per piegare fili · Aderer		H21
8821	Pinze per piegare fili		H22
8822-1	Pinze per piegare fili · How		H23
8822-2	Pinze per piegare fili · How		H23
8823	Pinze per piegare fili · Schwarz		H25
8824-1TC	Tronchesi		H6
8825	Pinze per piegare fili		H25
8826-1TC	Tronchesi		H5
8827-1TC	Tronchesi		H6
8828-1TC	Pinze di utilità		H33
8829	Pinze per piegare fili · Jarabak		H27
8830	Pinze per piegare fili		H27
8831	Pinze di utilità		H32
8831-1P	Pinze di utilità		H32
8832	Posizionatore di Bracket		H36
9002	Valigia portastrumenti e pinze		D71
9002-1	Inseriti per 6 pinze estrattive		D71
9002-2	Inseriti con elastici per 10 strumenti		D71
9002-3	Inseriti con spazi per 16 strumenti		D71
AL2720-LA	Vassoio portastrumenti in alluminio anodizzato colorato · Argento		I8
AL2720-LC	Vassoio portastrumenti in alluminio anodizzato colorato · Celeste		I8
AL2720-LO	Vassoio portastrumenti in alluminio anodizzato colorato · Oro		I8
AL2720-LR	Vassoio portastrumenti in alluminio anodizzato colorato · Rosso		I8
AL2720-LV	Vassoio portastrumenti in alluminio anodizzato colorato · Verde		I8
AL2720-UA	Vassoio portastrumenti in alluminio anodizzato colorato · Argento		I8
AL2721-LA	Vassoio portastrumenti in alluminio anodizzato colorato · forati · Argento		I9
AL2721-LC	Vassoio portastrumenti in alluminio anodizzato colorato · forati · Celeste		I9
AL2721-LO	Vassoio portastrumenti in alluminio anodizzato colorato · forati · Oro		I9
AL2721-LR	Vassoio portastrumenti in alluminio anodizzato colorato · forati · Rosso		I9
AL2721-LV	Vassoio portastrumenti in alluminio anodizzato colorato · forati · Verde		I9

codice	descrizione	manico	pagina	codice	descrizione	manico	pagina	codice	descrizione	manico	pagina	codice	descrizione	manico	pagina
AL2721-UA	Vassoi portastrumenti in alluminio anodizzato colorato · forati · Argento		I9	AL2739-1	Porta vassoi in alluminio · 6 ripiani		I13	AL2765-O	Accessori · distributori di cotone in alluminio anodizzato		I18	LV1827-204S	Curette e Scaler	Leonardo Light LV	G8
AL2722-LA	Vassoi portastrumenti in alluminio anodizzato colorato · Argento		I10	AL2739-2	Porta vassoi in alluminio · 6 ripiani		I13	AL2765-R	Accessori · distributori di cotone in alluminio anodizzato		I18	LV1829-CK6	Curette e Scaler · Crane-Kaplan	Leonardo Light LV	G8
AL2722-LC	Vassoi portastrumenti in alluminio anodizzato colorato · Celeste		I10	AL2740-1	Contentori per endodonzia		I14	AL2765-V	Accessori · distributori di cotone in alluminio anodizzato		I18	MB026-1	Compasso in acciaio inox		J19
AL2722-LO	Vassoi portastrumenti in alluminio anodizzato colorato · Oro		I10	AL2740-2	Contentori per endodonzia		I14	AL2766	Accessori · contenitori in plastica per aghi usati	A21	I19	MC0700-23	Sonde singole	Magic Color MC	B6
AL2722-LR	Vassoi portastrumenti in alluminio anodizzato colorato · Rosso		I10	AL2740-3	Contentori per endodonzia		I14	AL2767-1	Accessori · porta rifiuti	A22	I18	MC0700-6	Sonde singole	Magic Color MC	B6
AL2722-LV	Vassoi portastrumenti in alluminio anodizzato colorato · Verde		I10	AL2740-4	Contentori per endodonzia		I14	AL2767-2	Accessori · supporto in alluminio per porta rifiuti	A22	I18	MC0700-9	Sonde singole	Magic Color MC	B6
AL2722-UA	Vassoi portastrumenti in alluminio anodizzato colorato · Argento		I10	AL2740-5	Contentori per endodonzia		I14	LV1807-02	Curette Gracey · Gracey	Leonardo Light LV	G11	MC0702-12	Sonde millimetriche parodontali	Magic Color MC	E32
AL2723-LA	Vassoi portastrumenti in alluminio anodizzato colorato · Argento		I11	AL2740-R	Contentori per endodonzia		I15	LV1807-02AF	Curette Gracey · AF · Gracey	Leonardo Light LV	G12	MC0702-OMS	Sonde millimetriche parodontali	Magic Color MC	G3
AL2723-LC	Vassoi portastrumenti in alluminio anodizzato colorato · Celeste		I11	AL2741-1	Contentori per endodonzia		I14	LV1807-02MF	Curette Gracey · MF · Gracey	Leonardo Light LV	G13	MC0703-14	Sonde millimetriche parodontali	Magic Color MC	G3
AL2723-LO	Vassoi portastrumenti in alluminio anodizzato colorato · Oro		I11	AL2741-2	Contentori per endodonzia		I14	LV1807-04	Curette Gracey · Gracey	Leonardo Light LV	G11	MC0704-11/12AF	Sonde doppie	Magic Color MC	B8
AL2723-LR	Vassoi portastrumenti in alluminio anodizzato colorato · Rosso		I11	AL2742-1	Contentori per endodonzia		I15	LV1807-04AF	Curette Gracey · AF · Gracey	Leonardo Light LV	G12	MC0704-23D1	Sonde doppie	Magic Color MC	B8
AL2723-LV	Vassoi portastrumenti in alluminio anodizzato colorato · Verde		I11	AL2742-2	Contentori per endodonzia		I15	LV1807-04MF	Curette Gracey · MF · Gracey	Leonardo Light LV	G13	MC0704-6D9	Sonde doppie	Magic Color MC	B8
AL2723-UA	Vassoi portastrumenti in alluminio anodizzato colorato · Argento		I11	AL2742-3	Contentori per endodonzia		I15	LV1807-06	Curette Gracey · Gracey	Leonardo Light LV	G11	MC0707-GFW	Combinazioni sonde · Sonde millimetriche · Goldman-Fox Williams	Magic Color MC	B11
AL2724-1	Contentori in alluminio anodizzato per vassoi portastrumenti		I13	AL2742-4	Contentori per endodonzia		I15	LV1807-06AF	Curette Gracey · AF · Gracey	Leonardo Light LV	G12	MC0708-2N	Sonde doppie · Nabers	Magic Color MC	B11
AL2724-2	Contentori in alluminio anodizzato per vassoi portastrumenti		I13	AL2742-5	Contentori per endodonzia		I15	LV1807-06MF	Curette Gracey · MF · Gracey	Leonardo Light LV	G13	MC0800-1	Strumenti per trattamenti canalari	Magic Color MC	B12
AL2724-3	Contentori in alluminio anodizzato per vassoi portastrumenti		I13	AL2742-6	Contentori per endodonzia		I15	LV1807-08	Curette Gracey · Gracey	Leonardo Light LV	G11	MC0800-2	Strumenti per trattamenti canalari	Magic Color MC	B12
AL2724-4	Contentori in alluminio anodizzato per vassoi portastrumenti		I13	AL2742-7	Contentori per endodonzia		I15	LV1807-08AF	Curette Gracey · AF · Gracey	Leonardo Light LV	G12	MC0800-3	Strumenti per trattamenti canalari	Magic Color MC	B12
AL2725	Accessori per endodonzia		I16	AL2743	Contentori per endodonzia		I15	LV1807-08MF	Curette Gracey · MF · Gracey	Leonardo Light LV	G13	MC0802-2	Otturatori per canali · Schilder	Magic Color MC	B14
AL2727-1	Vassoi in plastica		A10	AL2744	Contentori per endodonzia		I15	LV1807-10	Curette Gracey · Gracey	Leonardo Light LV	G11	MC0802-4	Otturatori per canali · Schilder	Magic Color MC	B14
AL2727-1AZ	Vassoi in plastica		A10	AL2745-1A	Accessori per endodonzia		I16	LV1807-11MD	Curette Gracey · Gracey	Leonardo Light LV	G11	MC0802-6	Otturatori per canali · Schilder	Magic Color MC	B14
AL2727-1CZ	Vassoi in plastica		A10	AL2745-2C	Accessori per endodonzia		I16	LV1807-12	Curette Gracey · Gracey	Leonardo Light LV	G11	MC0803-1	Otturatori per canali · Machtou	Magic Color MC	B13
AL2727-1GZ	Vassoi in plastica		A10	AL2746-1	Accessori per endodonzia		I16	LV1807-12AF	Curette Gracey · AF · Gracey	Leonardo Light LV	G12	MC0803-2	Otturatori per canali · Machtou	Magic Color MC	B13
AL2727-1OZ	Vassoi in plastica		A10	AL2746-2	Accessori per endodonzia		I16	LV1807-12MF	Curette Gracey · MF · Gracey	Leonardo Light LV	G13	MC0803-3	Otturatori per canali · Machtou	Magic Color MC	B13
AL2727-1Z	Vassoi in plastica		A10	AL2747-1A	Accessori per endodonzia		I16	LV1807-13MD	Curette Gracey · Gracey	Leonardo Light LV	G11	MC0803-4	Otturatori per canali · Machtou	Magic Color MC	B13
AL2727-2	Vassoi in plastica		A11	AL2747-1A	Accessori per endodonzia		I16	LV1807-14	Curette Gracey · Gracey	Leonardo Light LV	G11	MC1102-1	Spatole · Heidemann	Magic Color MC	F24
AL2727-2AZ	Vassoi in plastica		A11	AL2760-1	Porta frese · con bordo, 24 fori FG		I17	LV1807-14AF	Curette Gracey · AF · Gracey	Leonardo Light LV	G12	MC1102-2	Spatole · Heidemann	Magic Color MC	F24
AL2727-2CZ	Vassoi in plastica		A11	AL2760-2	Porta frese · alluminio, sterilizzabile in autoclave a vapore saturo · con bordo, 24 fori CA		E34	LV1807-14MF	Curette Gracey · MF · Gracey	Leonardo Light LV	G13	MC1202-2	Otturatori per amalgama	Magic Color MC	F27
AL2727-2GZ	Vassoi in plastica		A11	AL2760-3	Porta frese · alluminio, sterilizzabile in autoclave a vapore saturo · con bordo, 24 fori FG/CA		E34	LV1807-16	Curette Gracey · Gracey	Leonardo Light LV	G11	MC1204-1	Otturatori · Brunitori · Westcott	Magic Color MC	F31
AL2727-2OZ	Vassoi in plastica		A11	AL2760-U	Porta frese · coperchio		I17	LV1807-16AF	Curette Gracey · AF · Gracey	Leonardo Light LV	G12	MC1210-2	Strumenti per otturazioni plastiche	Magic Color MC	F35
AL2727-2Z	Vassoi in plastica		A11	AL2761-1	Porta frese · con bordo, 36 fori FG		I17	LV1807-16MF	Curette Gracey · MF · Gracey	Leonardo Light LV	G13	MC1215-18	Otturatori · Brunitori · Ball	Magic Color MC	F31
AL2730-1	Griglie portastrumenti in alluminio · per 11 strumenti		I8	AL2761-2	Porta frese · con bordo, 36 fori CA		I17	LV1807-18	Curette Gracey · Gracey	Leonardo Light LV	G11	MC1215-27S	Otturatori · Brunitori	Magic Color MC	F31
AL2730-2	Griglie portastrumenti in alluminio · per 17 strumenti		I8	AL2761-3	Porta frese · con bordo, 36 fori FG/CA		I17	LV1826-T03	Curette e Scaler · Taylor	Leonardo Light LV	G8	MC1400-2	Otturatori per amalgama · Markley	Magic Color MC	F29
AL2730-3	Griglie portastrumenti in alluminio · per 10 strumenti		I9	AL2761-U	Porta frese · coperchio		E34								
AL2730-4	Griglie portastrumenti in alluminio · per 11 strumenti		I9	AL2762-1	Porta frese · alluminio, sterilizzabile in autoclave a vapore saturo · 48 fori FG		I17								
AL2731-1	Griglie portastrumenti in alluminio · per 8 strumenti		I11	AL2762-2	Porta frese · alluminio, sterilizzabile in autoclave a vapore saturo · 48 fori CA		E34								
AL2731-2	Griglie portastrumenti in alluminio · per 4 strumenti		I11	AL2762-3	Porta frese · alluminio, sterilizzabile in autoclave a vapore saturo · 48 fori FG/CA		I17								
AL2735	Pozzetti		A21	AL2763-1	Porta frese		I17								
AL2736	Spatole per miscelazione		A21	AL2763-2	Porta frese		I17								
AL2738-1	Vassoi in plastica		A11	AL2764-A	Accessori · porta rifiuti in alluminio anodizzato		I18								
AL2738-2	Vassoi in plastica		A11	AL2764-C	Accessori · porta rifiuti in alluminio anodizzato		I18								
				AL2764-O	Accessori · porta rifiuti in alluminio anodizzato		I18								
				AL2764-R	Accessori · porta rifiuti in alluminio anodizzato		I18								
				AL2764-V	Accessori · porta rifiuti in alluminio anodizzato		I18								
				AL2765-A	Accessori · distributori di cotone in alluminio anodizzato		I18								
				AL2765-C	Accessori · distributori di cotone in alluminio anodizzato		I18								

codice	descrizione	manico	pagina	codice	descrizione	manico	pagina	codice	descrizione	manico	pagina	codice	descrizione	manico	pagina		
MC1500-02	Strumenti per modellare amalgama/cera · Hollenback	Magic Color MC	F36 K13	MC1829-CK6S	Curette Gracey · Mini Crane-Kaplan	Magic Color MC	G8	ML1711-12	Escavatori · Darby-Perry	Leonardo ML	F17	ML1906-2	Scaler · Jacquette	Leonardo ML	G15		
MC1510-1D	Strumenti per composito	Magic Color MC	F50	MC1902-1	Scaler · Towner Jacquette	Magic Color MC	G14	ML1711-2	Escavatori · Darby-Perry	Leonardo ML	F17	ML1906-3	Scaler · Jacquette	Leonardo ML	G15		
MC1510-2D	Strumenti per composito	Magic Color MC	F50	MC2000-1	Cucchiai alveolari · Hemingway	Magic Color MC	C45 E21 G20	ML1711-21	Escavatori · Darby-Perry	Leonardo ML	F17	ML2000-1	Cucchiai alveolari · Hemingway	Leonardo ML	C45 E21 G20		
MC1510-3D	Strumenti per composito	Magic Color MC	F50	MC2000-2	Cucchiai alveolari · Hemingway	Magic Color MC	C45 E21 G20	ML1711-22	Escavatori · Darby-Perry	Leonardo ML	F17	ML2000-2	Cucchiai alveolari · Hemingway	Leonardo ML	C45 E21 G20		
MC1510-4D	Strumenti per composito	Magic Color MC	F50	MC2000-3	Cucchiai alveolari · Hemingway	Magic Color MC	C45 E21 G20	ML1711-243	Escavatori · ASH	Leonardo ML	F15	ML2000-3	Cucchiai alveolari · Hemingway	Leonardo ML	C45 E21 G20		
MC1510-5D	Strumenti per composito	Magic Color MC	F50	MC2101-B	Manici per specchietti	Magic Color MC	B19	ML1711-31	Escavatori · Darby-Perry	Leonardo ML	F17	ML2000-4	Cucchiai alveolari · Hemingway	Leonardo ML	G20		
MC1600-1	Strumenti per modellare e rifinire otturazioni · cleoide-discoide	Magic Color MC	F38	ML0700-17	Sonde singole	Leonardo ML	B6	ML1711-32	Escavatori · Darby-Perry	Leonardo ML	F17	ML2001-85	Cucchiai alveolari · Lucas	Leonardo ML	G20		
MC1700-1	Escavatori - cucchiali	Magic Color MC	F13	ML0700-23	Sonde singole	Leonardo ML	B6	ML1711-41	Escavatori · Darby-Perry	Leonardo ML	F17	ML2001-86	Cucchiai alveolari · Lucas	Leonardo ML	G20		
MC1700-2	Escavatori - cucchiali	Magic Color MC	F13	ML0700-3	Sonde singole · Rhein	Leonardo ML	B6	ML1711-42	Escavatori · Darby-Perry	Leonardo ML	F17	ML2001-87	Cucchiai alveolari · Lucas	Leonardo ML	G20		
MC1700-3	Escavatori - cucchiali	Magic Color MC	F13	ML0700-6	Sonde singole	Leonardo ML	B6	ML1711-G2	Escavatori · ASH	Leonardo ML	F15	ML2001-88	Cucchiai alveolari · Lucas	Leonardo ML	G20		
MC1703-14	Escavatori - cucchiali	Magic Color MC	F14	ML0700-8	Sonde singole	Leonardo ML	B6	ML1803-D	Bisturi per gengivectomia · Kirkland	Leonardo ML	G24	ML2101	Manici per specchietti	Leonardo ML	B19		
MC1704-17	Escavatori - cucchiali	Magic Color MC	F14	ML0700-9	Sonde singole	Leonardo ML	B6	ML1804-D	Bisturi per gengivectomia · Orban	Leonardo ML	G24	MV1851-PR3	Scollaperiostio ed Elevatori · Prichard	Asa Light MV	E23 G16		
MC1806-14	Curette e Scaler · Columbia	Magic Color MC	G4	ML0702-OMS	Sonde millimetriche parodontali · Novatech	Leonardo ML	G3	ML1806-14	Curette e Scaler · Columbia	Leonardo ML	G4	MV2000-1	Cucchiai alveolari · Hemingway	Asa Light MV	C45 E21 G20		
MC1806-2RL	Curette e Scaler · Columbia	Magic Color MC	G4	ML0703-14	Sonde millimetriche parodontali · Williams	Leonardo ML	G3	ML1806-4RL	Curette e Scaler · Columbia	Leonardo ML	G4	MV2000-2	Cucchiai alveolari · Hemingway	Asa Light MV	C45 E21 G20		
MC1806-4RL	Curette e Scaler · Columbia	Magic Color MC	G4	ML0704-11/12AF	Sonde doppie	Leonardo ML	B8	ML1807-02	Curette Gracey · Gracey	Leonardo ML	G11	MV2000-3	Cucchiai alveolari · Hemingway	Asa Light MV	C45 E21 G20		
MC1807-02	Curette Gracey · Gracey	Magic Color MC	G11	ML0704-23D1	Sonde doppie	Leonardo ML	B8	ML1807-02AF	Curette Gracey · AF · Gracey	Leonardo ML	G12	MV0704-16D1	Sonde doppie	Asa Light MV	B8		
MC1807-02MF	Curette Gracey · MF · Gracey	Magic Color MC	G13	ML0704-6D2	Sonde doppie	Leonardo ML	B9	ML1807-02MF	Curette Gracey · MF · Gracey	Leonardo ML	G13	MV0704-16D2	Sonde doppie	Asa Light MV	B8		
MC1807-04	Curette Gracey · Gracey	Magic Color MC	G11	ML0704-6D9	Sonde doppie	Leonardo ML	B8	ML1807-04	Curette Gracey · Gracey	Leonardo ML	G11	MV0704-23D1	Sonde doppie	Asa Light MV	B8		
MC1807-04MF	Curette Gracey · MF · Gracey	Magic Color MC	G13	ML0705-23W	Combinazioni sonde - Sonde millimetriche · Williams	Leonardo ML	B10	ML1807-04MF	Curette Gracey · MF · Gracey	Leonardo ML	G13	MV0704-23D2	Sonde doppie	Asa Light MV	B8		
MC1807-06	Curette Gracey · Gracey	Magic Color MC	G11	ML0708-2N	Sonde doppie · Nabers	Leonardo ML	B11	ML1807-06AF	Curette Gracey · AF · Gracey	Leonardo ML	G12	MV0704-UT1	Sonde doppie · Cattoni	Asa Light MV	B8		
MC1807-06MF	Curette Gracey · MF · Gracey	Magic Color MC	G13	ML0800-1	Strumenti per trattamenti canalari	Leonardo ML	B12	ML1807-06MF	Curette Gracey · MF · Gracey	Leonardo ML	G13	MV0705-16GF	Combinazioni sonde - Sonde millimetriche · Goldman-Fox	Asa Light MV	B10		
MC1807-08	Curette Gracey · Gracey	Magic Color MC	G11	ML0800-2	Strumenti per trattamenti canalari	Leonardo ML	B12	ML1807-08	Curette Gracey · Gracey	Leonardo ML	G11	MV0705-16W	Combinazioni sonde - Sonde millimetriche · Williams	Asa Light MV	B10		
MC1807-08MF	Curette Gracey · MF · Gracey	Magic Color MC	G13	ML0800-3	Strumenti per trattamenti canalari	Leonardo ML	B12	ML1807-08AF	Curette Gracey · AF · Gracey	Leonardo ML	G12	MV0705-17GF	Combinazioni sonde - Sonde millimetriche · Goldman-Fox	Asa Light MV	B10		
MC1807-10	Curette Gracey · Gracey	Magic Color MC	G11	ML0802-1	Otturatori per canali · Schilder	Leonardo ML	B14	ML1807-08MF	Curette Gracey · MF · Gracey	Leonardo ML	G13	MV0705-17UM	Combinazioni sonde - Sonde millimetriche · University of Michigan	Asa Light MV	B10		
MC1807-12	Curette Gracey · Gracey	Magic Color MC	G11	ML0802-2	Otturatori per canali · Schilder	Leonardo ML	B14	ML1807-10	Curette Gracey · Gracey	Leonardo ML	G11	MV0705-17W	Combinazioni sonde - Sonde millimetriche · Williams	Asa Light MV	B11		
MC1807-12MF	Curette Gracey · MF · Gracey	Magic Color MC	G13	ML0802-3	Otturatori per canali · Schilder	Leonardo ML	B14	ML1807-11MD	Curette Gracey · Gracey	Leonardo ML	G11	MV0705-23GF	Combinazioni sonde - Sonde millimetriche · Goldman-Fox	Asa Light MV	B10		
MC1807-14	Curette Gracey · Gracey	Magic Color MC	G11	ML0802-4	Otturatori per canali · Schilder	Leonardo ML	B14	ML1807-12	Curette Gracey · Gracey	Leonardo ML	G11	MV0705-23UM	Combinazioni sonde - Sonde millimetriche · University of Michigan	Asa Light MV	B10		
MC1807-14MF	Curette Gracey · MF · Gracey	Magic Color MC	G13	ML0802-5	Otturatori per canali · Schilder	Leonardo ML	B14	ML1807-12AF	Curette Gracey · AF · Gracey	Leonardo ML	G12	MV0705-23W	Combinazioni sonde - Sonde millimetriche · Williams	Asa Light MV	B10		
MC1807-16	Curette Gracey · Gracey	Magic Color MC	G11	ML0802-6	Otturatori per canali · Schilder	Leonardo ML	B14	ML1807-12MF	Curette Gracey · MF · Gracey	Leonardo ML	G13	MV0705-3GF	Sonde per canali · Goldman-Fox	Asa Light MV	B10		
MC1807-16MF	Curette Gracey · MF · Gracey	Magic Color MC	G13	ML0802-7	Otturatori per canali · Schilder	Leonardo ML	B14	ML1807-14AF	Curette Gracey · AF · Gracey	Leonardo ML	G12	MV0706-2311	Combinazioni sonde - Sonde millimetriche	Asa Light MV	B10		
MC1807-18	Curette Gracey · Gracey	Magic Color MC	G11	ML0802-8	Otturatori per canali · Schilder	Leonardo ML	B14	ML1807-14MF	Curette Gracey · MF · Gracey	Leonardo ML	G13	MV0706-2312	Combinazioni sonde - Sonde millimetriche	Asa Light MV	B11		
MC1827-204S	Curette Gracey	Magic Color MC	G8	ML0802-9	Otturatori per canali · Schilder	Leonardo ML	B14	ML1807-16	Curette Gracey · Gracey	Leonardo ML	G11	MV0707-GFW	Combinazioni sonde - Sonde millimetriche · Goldman-Fox Williams	Asa Light MV	B11		
				ML0803-1	Otturatori per canali · Machtou	Leonardo ML	B13	ML1807-16AF	Curette Gracey · AF · Gracey	Leonardo ML	G12						
				ML0803-2	Otturatori per canali · Machtou	Leonardo ML	B13	ML1807-16MF	Curette Gracey · MF · Gracey	Leonardo ML	G13						
				ML0803-3	Otturatori per canali · Machtou	Leonardo ML	B13	ML1807-18	Curette Gracey · Gracey	Leonardo ML	G11						
				ML0803-4	Otturatori per canali · Machtou	Leonardo ML	B13	ML1809-1	Curette e Scaler · Goldman-Fox	Leonardo ML	G6						
				ML0804-1	Misuratore di profondità	Leonardo ML	E32	ML1809-2	Curette e Scaler · Goldman-Fox	Leonardo ML	G6						
				ML1401-0	Otturatori per amalgama · Foc	Leonardo ML	F30	ML1809-21	Curette e Scaler · Goldman-Fox	Leonardo ML	G6						
				ML1401-0S	Otturatori per amalgama · Foc	Leonardo ML	F30	ML1809-3	Curette e Scaler · Goldman-Fox	Leonardo ML	G6						
				ML1401-1	Otturatori per amalgama · Foc	Leonardo ML	F30	ML1809-4	Curette e Scaler · Goldman-Fox	Leonardo ML	G6						
				ML1401-1S	Otturatori per amalgama · Foc	Leonardo ML	F30	ML1809-5	Curette e Scaler · Goldman-Fox	Leonardo ML	G6						
				ML1401-2	Otturatori per amalgama · Foc	Leonardo ML	F30	ML1816-06	Bisturi per gengivectomia · Buck	Leonardo ML	G24						
				ML1401-2S	Otturatori per amalgama · Foc	Leonardo ML	F30	ML1825-14S	Curette e Scaler · Mc Call	Leonardo ML	G7						
				ML1710-14	Escavatori · SS. White	Leonardo ML	F16	ML1827-T03	Curette e Scaler · Taylor	Leonardo ML	G8						
				ML1710-17	Escavatori · SS. White	Leonardo ML	F16	ML1827-204S	Curette e Scaler	Leonardo ML	G8						
				ML1710-18	Escavatori · SS. White	Leonardo ML	F16	ML1829-CK6	Curette e Scaler · Crane-Kaplan	Leonardo ML	G8						
				ML1710-19	Escavatori · SS. White	Leonardo ML	F16	ML1829-CK6S	Curette e Scaler · Mini Crane-Kaplan	Leonardo ML	G8						
				ML1710-20	Escavatori · SS. White	Leonardo ML	F16	ML1830-YG08	Curette e Scaler · Younger-Good	Leonardo ML	G8						
				ML1710-5	Escavatori · SS. White	Leonardo ML	F16	ML1845-1	Periotomi	Leonardo ML	D68 E29						
				ML1711-1	Escavatori · Darby-Perry	Leonardo ML	F17	ML1845-2	Periotomi	Leonardo ML	D68 E29						
				ML1711-11	Escavatori · Darby-Perry	Leonardo ML	F17	ML1845-3	Periotomi	Leonardo ML	D68 E29						
								ML1900-M23	Scaler	Leonardo ML	G14						
								ML1902-1	Scaler · Towner Jacquette	Leonardo ML	G14						
								ML1903	Scaler · Towner	Leonardo ML	G14						
								ML1906-1	Scaler · Jacquette	Leonardo ML	G15						

codice	descrizione	manico	pagina
MV0710-6D1	Sonde per canali	Asa Light MV	B9
MV0710-6D2	Sonde per canali	Asa Light MV	B9
MV0710-6D3	Sonde per canali	Asa Light MV	B9
MV1102-1	Spatole · Heidemann	Asa Light MV	F24
MV1102-2	Spatole · Heidemann	Asa Light MV	F24
MV1102-3	Spatole · Heidemann	Asa Light MV	F24
MV1200-1	Otturatori per amalgama	Asa Light MV	F26
MV1200-2	Otturatori per amalgama	Asa Light MV	F26
MV1200-3	Otturatori per amalgama	Asa Light MV	F26
MV1200-4	Otturatori per amalgama	Asa Light MV	F26
MV1200-5	Otturatori per amalgama	Asa Light MV	F26
MV1201-1	Otturatori per amalgama	Asa Light MV	F26
MV1201-1L	Otturatori per amalgama	Asa Light MV	F26
MV1201-2	Otturatori per amalgama	Asa Light MV	F26
MV1201-2L	Otturatori per amalgama	Asa Light MV	F26
MV1201-3	Otturatori per amalgama	Asa Light MV	F26
MV1201-3L	Otturatori per amalgama	Asa Light MV	F26
MV1202-1	Otturatori per amalgama	Asa Light MV	F27
MV1202-1L	Otturatori per amalgama	Asa Light MV	F27
MV1202-2	Otturatori per amalgama	Asa Light MV	F27
MV1202-2L	Otturatori per amalgama	Asa Light MV	F27
MV1202-3	Otturatori per amalgama	Asa Light MV	F27
MV1202-3L	Otturatori per amalgama	Asa Light MV	F27
MV1202-4	Otturatori per amalgama	Asa Light MV	F27
MV1202-4L	Otturatori per amalgama	Asa Light MV	F27
MV1203-1	Otturatori per amalgama	Asa Light MV	F27
MV1203-2	Otturatori per amalgama	Asa Light MV	F27
MV1203-3	Otturatori per amalgama	Asa Light MV	F27
MV1204-1	Otturatori - Brunitori · Westcott	Asa Light MV	F31
MV1204-2	Otturatori - Brunitori · Westcott	Asa Light MV	F31
MV1205-1	Otturatori per amalgama · Ward	Asa Light MV	F28
MV1205-2	Otturatori per amalgama · Ward	Asa Light MV	F28
MV1206-1	Strumenti per otturazioni plastiche	Asa Light MV	F34
MV1206-2	Strumenti per otturazioni plastiche	Asa Light MV	F34
MV1207-1	Strumenti per otturazioni plastiche	Asa Light MV	F34
MV1207-2	Strumenti per otturazioni plastiche	Asa Light MV	F34
MV1208-1	Strumenti per otturazioni plastiche	Asa Light MV	F34
MV1208-2	Strumenti per otturazioni plastiche	Asa Light MV	F34
MV1208-3	Strumenti per otturazioni plastiche	Asa Light MV	F34
MV1209-1	Strumenti per otturazioni plastiche	Asa Light MV	F34
MV1209-2	Strumenti per otturazioni plastiche	Asa Light MV	F34
MV1209-3	Strumenti per otturazioni plastiche	Asa Light MV	F34
MV1210-1	Strumenti per otturazioni plastiche	Asa Light MV	F35
MV1210-2	Strumenti per otturazioni plastiche	Asa Light MV	F35
MV1210-3	Strumenti per otturazioni plastiche	Asa Light MV	F35
MV1211-0T	Otturatori per amalgama · Tanner	Asa Light MV	F28
MV1211-1T	Otturatori per amalgama · Tanner	Asa Light MV	F28
MV1211-2T	Otturatori per amalgama · Tanner	Asa Light MV	F28
MV1211-3T	Otturatori per amalgama · Tanner	Asa Light MV	F28
MV1212-01	Otturatori per amalgama · Marquette	Asa Light MV	F28
MV1213-H1	Otturatori per amalgama · Hollenback	Asa Light MV	F28
MV1213-H2	Otturatori per amalgama · Hollenback	Asa Light MV	F28
MV1213-H3	Otturatori per amalgama · Hollenback	Asa Light MV	F28
MV1213-H4	Otturatori per amalgama · Hollenback	Asa Light MV	F28
MV1214-2	Otturatori - Brunitori · Ladmore	Asa Light MV	F31
MV1214-3	Otturatori - Brunitori · Ladmore	Asa Light MV	F31
MV1215-18	Otturatori - Brunitori · Ball	Asa Light MV	F31
MV1215-27S	Otturatori - Brunitori	Asa Light MV	F31
MV1215-29	Otturatori - Brunitori · Ball	Asa Light MV	F31

codice	descrizione	manico	pagina
MV1216-1	Strumenti per otturazioni plastiche · Woodson	Asa Light MV	F35
MV1216-2	Strumenti per otturazioni plastiche · Woodson	Asa Light MV	F35
MV1216-3	Strumenti per otturazioni plastiche · Woodson	Asa Light MV	F35
MV1217-11	Strumenti per otturazioni plastiche	Asa Light MV	F35
MV1218-6	Strumenti per otturazioni plastiche	Asa Light MV	F35
MV1219-179	Strumenti per otturazioni plastiche	Asa Light MV	F35
MV1220-B2	Otturatori - Brunitori	Asa Light MV	F31
MV1221-31	Otturatori - Brunitori	Asa Light MV	F31
MV1230-1	Compattatori per osso		E35
MV1230-2	Compattatori per osso		E35
MV1231-1	Applicatori per osso	Asa Light MV	E29
MV1301	Applicatori per sottofondo	Asa Light MV	F39
MV1302	Applicatori per sottofondo	Asa Light MV	F39
MV1400-1	Otturatori per amalgama · Markley	Asa Light MV	F29
MV1400-2	Otturatori per amalgama · Markley	Asa Light MV	F29
MV1400-3	Otturatori per amalgama · Markley	Asa Light MV	F29
MV1400-4	Otturatori per amalgama · Markley	Asa Light MV	F29
MV1400-5	Otturatori per amalgama · Markley	Asa Light MV	F29
MV1400-6	Otturatori per amalgama · Markley	Asa Light MV	F29
MV1500-02	Strumenti per modellare amalgama/cera · Hollenback	Asa Light MV	F36 K13
MV1500-3	Strumenti per modellare amalgama/cera · Hollenback	Asa Light MV	F36 K13
MV1500-3S	Strumenti per modellare amalgama/cera · Hollenback	Asa Light MV	F36 K13
MV1501-1	Strumenti per modellare amalgama/cera · Ward	Asa Light MV	F36 K13
MV1501-1S	Strumenti per modellare amalgama/cera · Ward	Asa Light MV	F36 K13
MV1501-2	Strumenti per modellare amalgama/cera · Ward	Asa Light MV	F36 K13
MV1502-1	Strumenti per modellare amalgama/cera · Frahm	Asa Light MV	F36 K13
MV1507-8	Strumenti per modellare e rifinire otturazioni	Asa Light MV	F37
MV1600-1	Strumenti per modellare e rifinire otturazioni · cleoide-discoide	Asa Light MV	F38
MV1600-2	Strumenti per modellare e rifinire otturazioni · cleoide-discoide	Asa Light MV	F38
MV1600-3	Strumenti per modellare e rifinire otturazioni · cleoide-discoide	Asa Light MV	F38
MV1600-4	Strumenti per modellare e rifinire otturazioni · cleoide-discoide	Asa Light MV	F38
MV1601-1	Strumenti da smalto - finitori per bordi gengivali · distale · Black/26	Asa Light MV	F18
MV1601-2	Strumenti da smalto - finitori per bordi gengivali · mesiale · Black/27	Asa Light MV	F19
MV1601-3	Strumenti da smalto - finitori per bordi gengivali · distale · Black/28	Asa Light MV	F19
MV1601-4	Strumenti da smalto - finitori per bordi gengivali · mesiale · Black/29	Asa Light MV	F19
MV1602-1	Strumenti da smalto - finitori per bordi gengivali · distale · Black/77-78	Asa Light MV	F19
MV1602-2	Strumenti da smalto - finitori per bordi gengivali · mesiale · Black/79-80	Asa Light MV	F19
MV1603-1	Strumenti da smalto - scalpelli · Black/53-54	Asa Light MV	F18
MV1603-2	Strumenti da smalto - scalpelli · Black/51-52	Asa Light MV	F18

codice	descrizione	manico	pagina
MV1604-02	Strumenti da smalto - preparazione cavità · Wedelstaedt	Asa Light MV	F18
MV1604-04	Strumenti da smalto - preparazione cavità · Wedelstaedt	Asa Light MV	F18
MV1604-06	Strumenti da smalto - preparazione cavità · Wedelstaedt	Asa Light MV	F18
MV1700-0	Escavatori - cucchiai	Asa Light MV	F13
MV1700-1	Escavatori - cucchiai	Asa Light MV	F13
MV1700-2	Escavatori - cucchiai	Asa Light MV	F13
MV1700-3	Escavatori - cucchiai	Asa Light MV	F13
MV1700-4	Escavatori - cucchiai	Asa Light MV	F13
MV1701-1	Escavatori - cucchiai	Asa Light MV	F13
MV1701-2	Escavatori - cucchiai	Asa Light MV	F13
MV1702-6	Escavatori - cucchiai	Asa Light MV	F14
MV1703-14	Escavatori - cucchiai	Asa Light MV	F14
MV1704-17	Escavatori - cucchiai	Asa Light MV	F14
MV1704-17W	Escavatori - cucchiai ovali	Asa Light MV	F15
MV1705-18	Escavatori - cucchiai	Asa Light MV	F14
MV1705-18W	Escavatori - cucchiai ovali	Asa Light MV	F15
MV1706-19	Escavatori - cucchiai	Asa Light MV	F14
MV1706-19W	Escavatori - cucchiai ovali	Asa Light MV	F15
MV1707-39	Escavatori - cucchiai	Asa Light MV	F14
MV1709-31L	Escavatori - cucchiai	Asa Light MV	B15 F14
MV1709-32L	Escavatori - cucchiai	Asa Light MV	B15 F14
MV1709-33L	Escavatori - cucchiai	Asa Light MV	B15 F14
MV1801-D	Scalpellini chirurgici · TG	Asa Light MV	G26
MV1802-3	Scalpellini chirurgici · Ochsenbein	Asa Light MV	G26
MV1802-4	Scalpellini chirurgici · Ochsenbein	Asa Light MV	G26
MV1803-D	Bisturi per gengivectomia · Kirkland	Asa Light MV	G24
MV1804-D	Bisturi per gengivectomia · Orban	Asa Light MV	G24
MV1805-02	Curette e Scaler · Langer	Asa Light MV	G5
MV1805-04	Curette e Scaler · Langer	Asa Light MV	G5
MV1806-02	Curette e Scaler	Asa Light MV	G4
MV1806-14	Curette e Scaler · Columbia	Asa Light MV	G4
MV1806-2RL	Curette e Scaler · Columbia	Asa Light MV	G4
MV1806-412	Curette e Scaler · Columbia	Asa Light MV	G4
MV1806-414	Curette e Scaler · Columbia	Asa Light MV	G4
MV1806-4RL	Curette e Scaler · Columbia	Asa Light MV	G4
MV1807-02	Curette Gracey · Gracey	Asa Light MV	G11
MV1807-04	Curette Gracey · Gracey	Asa Light MV	G11
MV1807-06	Curette Gracey · Gracey	Asa Light MV	G11
MV1807-08	Curette Gracey · Gracey	Asa Light MV	G11
MV1807-10	Curette Gracey · Gracey	Asa Light MV	G11
MV1807-11MD	Curette Gracey · Gracey	Asa Light MV	G11
MV1807-12	Curette Gracey · Gracey	Asa Light MV	G11
MV1807-13MD	Curette Gracey · Gracey	Asa Light MV	G11
MV1807-14	Curette Gracey · Gracey	Asa Light MV	G11
MV1809-1	Curette e Scaler · Goldman-Fox	Asa Light MV	G6
MV1809-2	Curette e Scaler · Goldman-Fox	Asa Light MV	G6
MV1809-21	Curette e Scaler · Goldman-Fox	Asa Light MV	G6
MV1809-3	Curette e Scaler · Goldman-Fox	Asa Light MV	G6
MV1809-4	Curette e Scaler · Goldman-Fox	Asa Light MV	G6
MV1809-5	Curette e Scaler · Goldman-Fox	Asa Light MV	G6
MV1809-6	Curette e Scaler · Goldman-Fox	Asa Light MV	G6
MV1810-07	Lime · Hirschfeld	Asa Light MV	G22
MV1811-37	Chisels · back-action · Rhodes	Asa Light MV	G22
MV1812-02S	Lime · Sugarman	Asa Light MV	G22
MV1812-04S	Lime · Sugarman	Asa Light MV	G22
MV1813-10	Lime · Schluger	Asa Light MV	G22
MV1824-14	Curette e Scaler · anteriore · Indiana University	Asa Light MV	G5

codice	descrizione	manico	pagina
MV1824-18	Curette e Scaler · posteriore · Indiana University	Asa Light MV	G5
MV1825-12	Curette e Scaler · Mc Call	Asa Light MV	G7
MV1825-14	Curette e Scaler · Mc Call	Asa Light MV	G7
MV1825-14S	Curette e Scaler · Mc Call	Asa Light MV	G7
MV1825-18S	Curette e Scaler · Mc Call	Asa Light MV	G7
MV1825-20	Curette e Scaler · Mc Call	Asa Light MV	G7
MV1826-T03	Curette e Scaler · Taylor	Asa Light MV	G8
MV1827-204S	Curette e Scaler	Asa Light MV	G8
MV1829-CK6	Curette e Scaler · Crane-Kaplan	Asa Light MV	G8
MV1830-YG08	Curette e Scaler · Younger-Good	Asa Light MV	G8
MV1831-32	Curette e Scaler · Jacqueline	Asa Light MV	G9
MV1831-33	Curette e Scaler · Jacqueline	Asa Light MV	G9
MV1831-35	Curette e Scaler · Jacqueline	Asa Light MV	G9
MV1831-38	Curette e Scaler · Jacqueline	Asa Light MV	G9
MV1850-9A	Scollaperiostio ed Elevatori · Allen	Asa Light MV	E23 G16
MV1850-GF	Scollaperiostio ed Elevatori · GF Goldman-Fox	Asa Light MV	E22 G16
MV1850-M7	Scollaperiostio ed Elevatori · Molt	Asa Light MV	E23 G16
MV1850-M8	Scollaperiostio ed Elevatori · Molt	Asa Light MV	E23 G16
MV1850-M9	Scollaperiostio ed Elevatori · Molt	Asa Light MV	E23 G16
MV1851-2	Scollaperiostio ed Elevatori · Hourigan	Asa Light MV	E23 G16
MV1852-1	Scollaperiostio ed Elevatori · Hopkins	Asa Light MV	E24 G17
MV1852-2	Scollaperiostio ed Elevatori · Hopkins	Asa Light MV	E24 G17
MV1853-15	Scollaperiostio ed Elevatori · Freer	Asa Light MV	E24 G17
MV1853-16	Scollaperiostio ed Elevatori · Freer	Asa Light MV	E24 G17
MV1854-3	Scollaperiostio ed Elevatori · Mead	Asa Light MV	E24 G17
MV1855-1	Strumenti per rialzo del seno mascellare	Asa Light MV	E15
MV1855-2	Strumenti per rialzo del seno mascellare	Asa Light MV	E15
MV1855-3	Strumenti per rialzo del seno mascellare	Asa Light MV	E15
MV1855-4	Strumenti per rialzo del seno mascellare	Asa Light MV	E15
MV1855-5	Strumenti per rialzo del seno mascellare	Asa Light MV	E15
MV1855-6	Strumenti per rialzo del seno mascellare	Asa Light MV	E15
MV1856-1	Strumenti per rialzo del seno mascellare	Asa Light MV	E13
MV1856-2	Strumenti per rialzo del seno mascellare	Asa Light MV	E13
MV1856-3	Strumenti per rialzo del seno mascellare	Asa Light MV	E13
MV1856-4	Strumenti per rialzo del seno mascellare	Asa Light MV	E13
MV1856-5	Strumenti per rialzo del seno mascellare	Asa Light MV	E13
MV1856-6	Strumenti per rialzo del seno mascellare	Asa Light MV	E14
MV1856-7	Strumenti per rialzo del seno mascellare	Asa Light MV	E14

codice	descrizione	manico	pagina	codice	descrizione	manico	pagina	codice	descrizione	manico	pagina	codice	descrizione	manico	pagina
MV1856-8	Strumenti per rialzo del seno mascellare	Asa Light MV	E14	S0700-9	Sonde singole	Asa60	B7	S2723-2	Vassoio portastrumenti in acciaio Inox - per 4 strumenti		I7	S2807-6	Portaimpronta non forati in acciaio inox - PERMA-LOCK		J23
MV1883	Posizionatori di membrane · Buser	Asa Light MV	E31	S0702L-23	Kit per endodonzia · università di Boston		B25	S2724-1	Vassoio portastrumenti in acciaio Inox - per 8 strumenti		I7	S2807-8	Portaimpronta non forati in acciaio inox - PERMA-LOCK		J23
MV1902-1	Scaler · Towner Jacqueline	Asa Light MV	G14	S0702L-7	Kit per endodonzia · serie di 7 strumenti Laser System		B25	S2724-2	Vassoio portastrumenti in acciaio Inox - per 4 strumenti		I7	S2807A-12	Portaimpronta non forati in acciaio inox - PERMA-LOCK anatomic		J25
MV1902-2	Scaler · Towner Jacqueline	Asa Light MV	G14	S0800	Kit per endodonzia		B25	S2731-1	Vassoio porta uncini in acciaio inox completo di 8 uncini		F11	S2807A-6	Portaimpronta non forati in acciaio inox - PERMA-LOCK anatomic		J25
MV1904-H5	Scaler	Asa Light MV	G14	S0903-1	Spatole per cemento		F22	S2731-12	Vassoio porta uncini in acciaio inox completo di 12 uncini		F11	S2807A-8	Portaimpronta non forati in acciaio inox - PERMA-LOCK anatomic		J25
MV1904-H6	Scaler	Asa Light MV	G14	S0903-2	Spatole per cemento		F22	S2760-A	Porta frese in silicone colorato · Arancione		E34 I17	S2807S-12	Portaimpronta non forati in acciaio inox - PERMA-LOCK high grip		J27
MV1905-02	Scaler	Asa Light MV	G14	S0903-3	Spatole per cemento		F22	S2760-C	Porta frese in silicone colorato · Blu		E34 I17	S2807S-6	Portaimpronta non forati in acciaio inox - PERMA-LOCK high grip		J27
MV2000-4	Cucchiari alveolari · Hemingway	Asa Light MV	G20	S1102-1	Spatole - AsaLady · Heidemann	Asa60	F24	S2780-IMP	Strumenti per chirurgia implantare		E39	S2807S-8	Portaimpronta non forati in acciaio inox - PERMA-LOCK high grip		J27
MV2001-85	Cucchiari alveolari · Lucas	Asa Light MV	G20	S1102-2	Spatole - AsaLady · Heidemann	Asa60	F24	S2800-12	Portaimpronta forati in alluminio		J37	S2808-8	Portaimpronta non forati in acciaio inox per edentuli		J29
MV2001-86	Cucchiari alveolari · Lucas	Asa Light MV	G20	S1102-3	Spatole - AsaLady · Heidemann	Asa60	F24	S2801-12	Portaimpronta forati in acciaio inox		J13	S2809-6	Portaimpronta forati in acciaio inox - depressi anteriormente		J10
MV2001-87	Cucchiari alveolari · Lucas	Asa Light MV	G20	S1200-1	Otturatori per amalgama	Asa60	F26	S2801-6	Portaimpronta forati in acciaio inox		J13	S2810-6	Portaimpronta non forati in acciaio inox - depressi anteriormente		J28
MV2001-88	Cucchiari alveolari · Lucas	Asa Light MV	G20	S1200-2	Otturatori per amalgama	Asa60	F26	S2801-8	Portaimpronta forati in acciaio inox		J13	S2811-1	Portaimpronta forati in acciaio inox · Ehrlicke		J16
MV2002-1	Lime per alveolotomia · Wahl	Asa Light MV	G23	S1200-3	Otturatori per amalgama	Asa60	F26	S2801A-12	Portaimpronta forati in acciaio inox - ANATOMIC		J15	S2811-2	Portaimpronta forati in acciaio inox · Ehrlicke		J16
MV2002-2	Lime per alveolotomia · Wahl	Asa Light MV	G23	S1200-4	Otturatori per amalgama	Asa60	F26	S2801A-6	Portaimpronta forati in acciaio inox - ANATOMIC		J15	S2811-3	Portaimpronta forati in acciaio inox · Ehrlicke		J17
PR0460-15TC	Porta aghi · punte curve · Castroviejo TC		C18 E6	S1200-5	Otturatori per amalgama	Asa60	F26	S2801A-8	Portaimpronta forati in acciaio inox - ANATOMIC		J15	S2811-4	Portaimpronta forati in acciaio inox · Ehrlicke		J17
PR0625-2	Pinzette per sutura		C40 E36	S1200T	Otturatori per amalgama	Asa60	F25	S2802-12	Portaimpronta non forati in acciaio inox		J33	S2813	Portaimpronta forati in acciaio inox per edentuli		J19
PR0625-3	Pinzette per sutura		C40 E36	S1222-15	Strumenti per composito	Alu60	F32	S2802-6	Portaimpronta non forati in acciaio inox		J33	S2816-6	Portaimpronta forati in alluminio - ORTHOBABY per bambini		J39
PR0632-1	Pinzette chirurgiche · Cooley		C38	S1222-7	Strumenti per composito		F51	S2802-8	Portaimpronta non forati in acciaio inox		J33	S2851-24	Portaimpronta in policarbonato per Eedentuli		J43
PR1801-1	Scalpellini e sgorbie per parodontologia	Perfection	G27	S1400	Otturatori per amalgama · Markley	Asa60	F29	S2802A-12	Portaimpronta non forati in acciaio inox - ANATOMIC		J35	S2880-12	Portaimpronta forati in alluminio per implantologia		J38
PR1850-1	Scollaperiostio ed Elevatori	Perfection	E24 G18	S1700	Escavatori - cucchiari	Asa60	F13	S2802A-6	Portaimpronta non forati in acciaio inox - ANATOMIC		J35	S2880-12FR	Portaimpronta forati in alluminio per implantologia		J38
PR1850-M	Dissettori · Buser	Perfection	E22 G16	S1700-0	Escavatori - cucchiari	Asa60	F13	S2802A-8	Portaimpronta non forati in acciaio inox - ANATOMIC		J35	S3000	Kit di strumenti per diga		F10
PR1857-1	Dissettori	Perfection	D68 E22	S1700-1	Escavatori - cucchiari	Asa60	F13	S2803-10	Portaimpronta non forati in acciaio inox - NEW SUPER		J21	S3001-20	Strumenti per chirurgia implantare · Goracci kit		E40
PR1859-1	Strumenti per sinus lift	Perfection	E14	S1700-2	Escavatori - cucchiari	Asa60	F13	S2803S-10	Portaimpronta non forati in acciaio inox - NEW SUPER high grip		J31	S3002-13	Kit di strumenti per chirurgia orale		C46
PR1859-2	Strumenti per sinus lift	Perfection	E14	S1700-3	Escavatori - cucchiari	Asa60	F13	S2804-12	Portaimpronta forati in acciaio inox - PERMA-LOCK		J5	S3002-17	Kit di strumenti per chirurgia orale		C46
S0100-1	Pinze per estrazione		D4	S1700-4	Escavatori - cucchiari	Asa60	F13	S2804-6	Portaimpronta forati in acciaio inox - PERMA-LOCK		J5	S3002-18	Kit di strumenti per chirurgia orale		C47
S0100-2	Pinze per estrazione		D5	S1710-6	Escavatori · SS. White	Asa60	F16	S2804-8	Portaimpronta forati in acciaio inox - PERMA-LOCK		J5	S3003-11	Strumenti per chirurgia implantare		E41
S0100-3	Kit per chirurgia orale ed estrattiva		D70	S1800-23	Kit di strumenti per parodontologia		G37	S2804A-12	Portaimpronta forati in acciaio inox - PERMA-LOCK anatomic		J7	S3003-9	Strumenti per chirurgia implantare		E41
S0100-4	Kit per chirurgia orale ed estrattiva		D70	S1806	Curette e Scaler	Asa60	G4	S2804A-6	Portaimpronta forati in acciaio inox - PERMA-LOCK anatomic		J7	S5112	Strumenti per modellare amalgama/cera	Asa60	K17
S0110	Pinze per estrazione per bambini		D38	S1807	Curette Gracey	Asa60	G34	S2804A-8	Portaimpronta forati in acciaio inox - PERMA-LOCK anatomic		J7	S5112AL	Strumenti per modellare amalgama/cera	Alu80	K17
S0112	Pinze per estrazione per bambini · Klein		D39	S1807-3	Curette Gracey	Asa60	G34	S2804S-12	Portaimpronta non forati in acciaio inox - PERMA-LOCK high grip		J9	S5160	Strumenti per cera con punte intercambiabili		K18
S0200-10	Leve per radici		D49	S1807AF-3	Curette Gracey	Asa60	G34	S2804S-6	Portaimpronta non forati in acciaio inox - PERMA-LOCK high grip		J9	S5160-1C	Strumenti per cera con punte intercambiabili	Alu80	K18
S0200-6	Leve per radici		D47	S1807MF	Curette Gracey	Asa60	G34	S2804S-8	Portaimpronta non forati in acciaio inox - PERMA-LOCK high grip		J9	S5160-2C	Strumenti per cera con punte intercambiabili	Alu80	K18
S0244-6	Leve per radici		D50	S1807MF-3	Curette Gracey	Asa60	G34	S2806-8	Portaimpronta non forati in acciaio inox per edentuli		J11	S5160-3C	Strumenti per cera con punte intercambiabili	Alu80	K18
S0296	Kit di Sindesmotomi		D69	S1809	Curette e Scaler	Asa60	G6	S2807-12	Portaimpronta non forati in acciaio inox - PERMA-LOCK		J23	S5800	Vassoio porta pinze		I12
S0296-1	Kit di Sindesmotomi		D69	S1890	Pietre per affilare		G33					S6810-1	Lab Set per Odontotecnica		K35
S0352	Kit composto da pinza toglielame e manico per bisturi		C24 E9	S1899	Kit di strumenti per parodontologia		G35								
S0495-6	Osteotomi		E19	S2100	Manici per specchietti · serie da 5 pz	Octagonal	B19								
S0498-8	Strumenti per chirurgia implantare · kit mini rialzo del seno		E40	S2101	Manici per specchietti · serie da 5 pz	Asa60	B19								
S0600-1	Kit prima visita parodontale		G36	S2102-IN	Manici per specchietti · serie da 5 pz, vuoti	Exagonal	B19								
S0600-23	Kit strumenti prima visita		B22	S2002-6	Specchietto parallelizzatore con manico	Asa60	B19								
S0600-6	Kit strumenti prima visita		B22	S2700	Vassoio portastrumenti in acciaio Inox · per 7 strumenti		I6								
S0600-9	Kit strumenti prima visita		B22	S2702	Vassoio portastrumenti in acciaio Inox · per 7 strumenti		I6								
S0600-M	Kit strumenti prima visita		A21	S2720-1	Vassoio portastrumenti in acciaio Inox · per 16 strumenti		I5								
S0601-1	Pinzette per medicazioni · Flagg		B4	S2720-2	Vassoio portastrumenti in acciaio Inox · per 23 strumenti		I5								
S0601-2	Pinzette per medicazioni · London-College		B4	S2721-1	Vassoio portastrumenti in acciaio Inox · per 16 strumenti		I4								
S0601-3	Pinzette per medicazioni · Meriam		B4	S2721-2	Vassoio portastrumenti in acciaio Inox · per 23 strumenti		I4								
S0645	Set di pinzette chirurgiche		C42	S2722-1	Vassoio portastrumenti in acciaio Inox · per 16 strumenti		I4								
S0690-2	Divaricatore ultralight		B21	S2722-2	Vassoio portastrumenti in acciaio Inox · per 23 strumenti		I4								
S0700-11	Sonde singole	Asa60	B7	S2723-1	Vassoio portastrumenti in acciaio Inox · per 8 strumenti		I7								
S0700-16	Sonde singole	Asa60	B7												
S0700-23	Sonde singole	Asa60	B7												
S0700-6	Sonde singole	Asa60	B7												

codice	descrizione	manico	pagina
S6810-2	Lab Set per Odontotecnica		K35
S6811-2	Lab Set per Odontotecnica		K34
SLV1807	Curette Gracey	Leonardo Light LV	G34
SLV1807AF	Curette Gracey	Leonardo Light LV	G34
SLV1807MF	Curette Gracey	Leonardo Light LV	G34
SMC0600-23	Kit strumenti prima visita - Magic Color		B23
SMC0600-6	Kit strumenti prima visita - Magic Color		B23
SMC0600-9	Kit strumenti prima visita - Magic Color		B23
SMC0700-5	Kit di strumenti diagnostici - Magic Color		B24
SMC0800-5	Kit di strumenti endodontici - Magic Color		B24
SMC1807	Curette Gracey	Magic Color MC	G34
SMC1807-5	Kit di strumenti per parodontologia		G35
SML1807	Curette Gracey	Leonardo ML	G34
SML1807AF	Curette Gracey	Leonardo ML	G34
SML1807MF	Curette Gracey	Leonardo ML	G34
SMV1400	Otturatori per amalgama · Markley	Asa Light MV	F29
SMV1700	Escavatori - cucchiari	Asa Light MV	F13
SMV1806	Curette e Scaler	Asa Light MV	G4
SMV1807	Curette Gracey	Asa Light MV	G34
SMV1809	Curette e Scaler	Asa Light MV	G6
SPR0495	Strumenti per chirurgia implantare · Kit mini rialzo del seno		E39
SPR0496	Strumenti per chirurgia implantare · Kit grande rialzo del seno		E38
SPR2781-I	Kit chirurgia implantare		E38
SPR2781-P	Kit chirurgia parodontale		G36
SPR2781-S	Kit chirurgia orale		D70
SVS2731-6	Vision® Shade · vassoio magnetico in acciaio inox con 6 uncini		F2
SVS3000	Vision® Shade kit		F3
SWML0600-23	Kit strumenti prima visita - AsaLady		B22
SWML0600-6	Kit strumenti prima visita - AsaLady		B22
SWML0600-9	Kit strumenti prima visita - AsaLady		B22
VS3045	Vision® Shade · confezione di 60 dighe di gomma (colore nero, profumo menta)		F2
VS3051-210	Vision® Shade · uncino con alette		F2
VS3052-12A	Vision® Shade · uncino dentellato con alette		F2
VS3052-13A	Vision® Shade · uncino dentellato con alette		F2
VS3052-2	Vision® Shade · uncino con alette		F2
VS3052-W4	Vision® Shade · uncino senza alette		F2
VS3052-W8	Vision® Shade · uncino senza alette		F2
VV2731-6	Vision® Shade · vassoio magnetico in acciaio inox senza uncini		F2
VV3030	Vision® Shade · pinze per uncini in acciaio inox		F2
VV3033	Vision® Shade · pinza foradiga in acciaio inox		F2
VV3035	Vision® Shade · dima di foratura in acciaio inox		F2
VV3040-2	Vision® Shade · telaio per diga in acciaio inox 100x150 mm		F2

codice	descrizione	manico	pagina
VVPEN	Vision® Shade · pennarello per uso alimentare		F3
W0121-101	Pinze per estrazione forma americana - AsaLady · Hull		D31
W0121-10S	Pinze per estrazione forma americana - AsaLady		D29
W0121-150	Pinze per estrazione forma americana - AsaLady · Cryer		D32
W0121-150S	Pinze per estrazione forma americana - AsaLady · Cryer		D32
W0121-151	Pinze per estrazione forma americana - AsaLady · Cryer		D32
W0121-151S	Pinze per estrazione forma americana - AsaLady · Cryer		D32
W0121-16	Pinze per estrazione forma americana - AsaLady		D29
W0121-17	Pinze per estrazione forma americana - AsaLady		D29
W0121-18L	Pinze per estrazione forma americana - AsaLady · Harris		D30
W0121-18R	Pinze per estrazione forma americana - AsaLady · Harris		D30
W0121-222	Pinze per estrazione forma americana - AsaLady		D32
W0121-23	Pinze per estrazione forma americana - AsaLady		D30
W0121-5	Pinze per estrazione forma americana - AsaLady · Physick		D29
W0121-53L	Pinze per estrazione forma americana - AsaLady		D30
W0121-53R	Pinze per estrazione forma americana - AsaLady		D30
W0121-6	Pinze per estrazione forma americana - AsaLady		D29
W0121-65	Pinze per estrazione forma americana - AsaLady		D31
W0121-69	Pinze per estrazione forma americana - AsaLady · Tomes		D31
W0121-88L	Pinze per estrazione forma americana - AsaLady · Nevius		D31
W0121-88R	Pinze per estrazione forma americana - AsaLady · Nevius		D31
W0160-1	Pinze per estrazione - AsaLady		D21
W0160-13	Pinze per estrazione - AsaLady		D21
W0160-145	Pinze per estrazione - AsaLady		D23
W0160-151/	Pinze per estrazione - AsaLady		D23
W0160-17	Pinze per estrazione - AsaLady		D21
W0160-18	Pinze per estrazione - AsaLady		D21
W0160-2	Pinze per estrazione - AsaLady		D21
W0160-21	Pinze per estrazione - AsaLady		D22
W0160-22	Pinze per estrazione - AsaLady		D22
W0160-33	Pinze per estrazione - AsaLady		D22
W0160-4	Pinze per estrazione - AsaLady		D21
W0160-45	Pinze per estrazione - AsaLady		D22
W0160-51A	Pinze per estrazione - AsaLady		D22
W0160-67A	Pinze per estrazione - AsaLady		D22
W0160-7	Pinze per estrazione - AsaLady		D21
W0160-74	Pinze per estrazione - AsaLady		D22
W0160-79	Pinze per estrazione - AsaLady		D23
W0160-86C	Pinze per estrazione - AsaLady		D23
W0298-3	Sindesmotomi - AsaLady · Chompret		D65
W0319-1	Forbicine per gengive - AsaLady · rette		C3

codice	descrizione	manico	pagina
W0319-2	Forbicine per gengive - AsaLady · curve		C3
W0349-3	Manici per bisturi - AsaLady		C26 E7
W0411-15	Porta aghi - AsaLady · Crile-Wood		C11
W0411-15TC	Porta aghi - AsaLady · Crile-Wood TC		C11
W0412-16	Porta aghi - AsaLady · Mayo-Hegar		C12
W0412-16TC	Porta aghi - AsaLady · Mayo-Hegar		C12
W0502-1	Pinze emostatiche - AsaLady · Halstead-Mosquito		C21
W0502-2	Pinze emostatiche - AsaLady · Halstead-Mosquito		C21
W0610-1	Pinzette per medicazioni - AsaLady · Flagg		B5
W0610-2	Pinzette per medicazioni - AsaLady · London College		B5
W0610-3	Pinzette per medicazioni - AsaLady · Meriam		B5
W3035	Pinze per uncini - AsaLady · Ivory lightweight		F9
W3036	Pinze per forare la diga - AsaLady · Ainsworth		F8
WML1102-1	Spatole - AsaLady · Heidemann	Leonardo ML	F24
WML1102-2	Spatole - AsaLady · Heidemann	Leonardo ML	F24
WML1102-3	Spatole - AsaLady · Heidemann	Leonardo ML	F24

INDICE DEI PRODOTTI

descrizione	pagina
Abbassalingua	C34
Accessori per endodonzia	E11
Applicatori per osso	I16
Applicatori per sottofondo	E29
Apribocca	E31
Arco facciale · forchetta	C33
Arco facciale · porta forchetta	K10
Arco facciale · set completo (Easy Bow)	K10
Articolatore 5002	K6
Articolatore 5030	K4
Articolatore 5032	K5
Articolatore 5050	K2
Articolatore 5050Plus	K3
Articolatori (asse cerniera)	K9
Articolatori (asta antiribaltamento apertura 180°)	K9
Articolatori (asta con magneti incollato)	K9
Articolatori (asta incisale)	K9
Articolatori (asta movimento condilare)	K9
Articolatori (asta posteriore)	K9
Articolatori (calotta)	K9
Articolatori (camicia porta magneti)	K7
	K9
Articolatori (cappuccio in gomma)	K9
Articolatori (cilindro per movimenti laterali)	K9
Articolatori (contromagnete per gesso)	K7
	K9
Articolatori (controvite)	K9
Articolatori (distanziatore)	K7
	K9
Articolatori (ghiera per asta)	K9
Articolatori (Indicatore incisale)	K9
Articolatori (kit asta magnetica)	K9
Articolatori (magnete)	K7
	K9
Articolatori (molla interna asse cerniera)	K9
Articolatori (molla per movimenti laterali)	K9
Articolatori (piano di occlusione)	K9
Articolatori (piano incisale (0°))	K9
Articolatori (piano incisale (10°))	K9
Articolatori (piano inclinato di contrasto)	K9
Articolatori (piano occlusale completo)	K9
Articolatori (piano per asta magnetica)	K9
Articolatori (piastrina di montaggio)	K6
	K9
Articolatori (piastrina magnetica completa)	K7
	K9
Articolatori (piedini in gomma)	K9
Articolatori (pomelli di serraggio per distanziatore)	K9
Articolatori (pomelli di serraggio)	K9
Articolatori (pomelli metallici di serraggio)	K9
Articolatori (pomello zigrinato per piano occlusale e calotta)	K9
Articolatori (porta asta posteriore)	K9
Articolatori (rondella di rasamento asse cerniera)	K9

descrizione	pagina
Articolatori (supporto per piano occlusale e calotta)	K9
Articolatori (taratore)	K9
Articolatori (vite micrometrica di registrazione)	K9
Articolatori (vite per regolazione molla movimenti laterali)	K9
Articolatori (viti M5 per fissaggio base incisale)	K9
Aspiratori chirurgici	E33
Bacinelle inox reneiformi	I12
Bicchieri	A20
Bisturi monouso	C25
	E10
Blocca strumenti · per 10 posti - Arancione - silicone	I3
Blocca strumenti · per 10 posti - Blu - silicone	I3
Blocca strumenti · per 10 posti - Rosso - silicone	I3
Blocca strumenti · per 10 posti - Verde - silicone	I3
Blocca strumenti · per 5 posti - Arancione - silicone	I3
Blocca strumenti · per 5 posti - Blu - silicone	I3
Blocca strumenti · per 5 posti - Rosso - silicone	I3
Blocca strumenti · per 5 posti - Verde - silicone	I3
Brunitori	F31
Buste per sterilizzazione	A18
Calibri	E33
	F42
	K30
Calibri - alluminio, divisione in millimetri e pollici	K30
Calibri (per cera e metallo)	F42
	K30
Cannule aspirasaliva	A4
	A5
Cannule aspirasaliva (Asa Fresh)	A2
Cannule aspirasaliva (Total Comfort)	A3
Cannule chirurgiche	C44
Cannule chirurgiche in acciaio inox	C44
Cassette portastrumenti · implantologia - h. 60 mm	I2
Cassette portastrumenti · large - per 15 strumenti - Arancione	I2
Cassette portastrumenti · large - per 15 strumenti - Blu	I2
Cassette portastrumenti · large - per 15 strumenti - Rosso	I2
Cassette portastrumenti · large - per 15 strumenti - Verde	I2
Cassette portastrumenti · large - per 20 strumenti - Arancione	I2
Cassette portastrumenti · large - per 20 strumenti - Blu	I2
Cassette portastrumenti · large - per 20 strumenti - Rosso	I2
Cassette portastrumenti · large - per 20 strumenti - Verde	I2
Cassette portastrumenti · large - per 20 strumenti - Verde	I2
Cassette portastrumenti · medium - per 10 strumenti - Arancione	I2
Cassette portastrumenti · medium - per 10 strumenti - Blu	I2
Cassette portastrumenti · medium - per 10 strumenti - Rosso	I2
Cassette portastrumenti · medium - per 10 strumenti - Verde	I2
Cassette portastrumenti · medium - per 10 strumenti - Verde	I2
Cassette portastrumenti · medium - per 5 strumenti - Arancione	I2
	I3
Cassette portastrumenti · medium - per 5 strumenti - Blu	I2
	I3
Cassette portastrumenti · medium - per 5 strumenti - Rosso	I2
	I3
Cassette portastrumenti · medium - per 5 strumenti - Verde	I2
	I3
Catenelle reggi salviette	A7

descrizione	pagina
Cesioie taglia gesso	K31
Clips per cassette portastrumenti (forbici)	I3
Combinazioni sonde - Sonde millimetriche	B10
	B11
Compassi	J19
Compattatori per osso	E35
Condensatori	B15
Condensatori per trattamenti canalari	B12
Contenitori per endodonzia	I14
	I15
Contenitori per protesi/ortodontici	H47
	K27
Contenitori per vassoi	I13
Contenitori portarifiuti	A21
	A22
	I18
	I19
Cucchiari alveolari	C45
	E21
	G20
	G21
Curettes di Gracey	G11..G13
Curettes e Scalers	G4..G9
Dappen dishes	A8
	A9
Dighe in lattice	F8
Dima di foratura (Vision)	F2
Dissettori	D68
	E22
	G17
Distributori di palline di cotone (acciaio)	I19
Distributori per bicchieri	A20
Distributori per cortone (alluminio)	I18
Divaricatori	C35..C37
	E10
	E12
Divaricatori ultralight	B21
Easy Bow · tavolo di trasferimento	K10
Elevatori	D47
	D49
	D50
	E22..E24
	G16..G18
Escavatori	B15
	F13..F17
Escavatori - cucchiari	F13
	F14
Escavatori - cucchiari ovali	F15
Escavatori canalari	B15
	F14
Forbici per corone	F45
	K28
Forbicine per gengive	C8
Forbicine per gengive · angolari	C3
	C6
Forbicine per gengive · angolari, una punta dentata	C3
Forbicine per gengive · curve	C3..C5
	C7..C9
	E4
	K28
Forbicine per gengive · curve, punte acute	C7
Forbicine per gengive · curve, punte arrotondate	C7
Forbicine per gengive · curve, punte arrotondate	C9

descrizione	pagina
Forbicine per gengive · curve, una punta dentata	C3
	C4
	C6
	C7
	E4
Forbicine per gengive · rette	C3..C5
	C8
	C9
	E4
	F45
	K28
Forbicine per gengive · rette, una punta dentata	C3
	C6
	E4
Forbicine per gengive (AsaLady)	C3
Frese carotatrici millimetriche (trephine)	E34
Ghiaccio sintetico	A22
Griglie portastrumenti in alluminio	I8
	I9
	I11
Guanti per esame	A15
Guanti per esame (nitrile)	A16
	A17
Iniettori per osso	E27
Kit Curettes di Gracey	G34
Kit Curettes di Gracey (Leonardo)	F29
Kit Curettes di Gracey (Magic Color)	G34
Kit Curettes e Scalers	G4
	G6
Kit di isolamento dentale	F10
	F11
Kit di isolamento dentale Vision	F3
Kit divaricatori ultralight	B21
Kit escavatori	F13
	F16
Kit Goracci	E40
Kit manici per bisturi	C24
	E9
Kit manici per specchietti	B19
Kit pennelli per ceramica	K20
Kit per cera	K22
Kit per chirurgia implantare	E37
	E39
	E41
Kit per chirurgia implantare (Magic Color)	G35
Kit per chirurgia implantare (Perfection)	E38
	E39
kit per chirurgia orale	C46
	C47
	D70
Kit per chirurgia orale (Perfection)	D70
Kit per chirurgia parodontale (Perfection)	G36
Kit per diagnostica (Magic Color)	B24
Kit per endodonzia	B25
Kit per endodonzia (Magic Color)	B24
Kit per gengivectomia	G24
	G25
Kit per gesso	K23
Kit per isolamento dentale	F10
	F11
Kit per parodontologia	G35
	G36
	G37
Kit pietre per affilare	G33

descrizione	pagina	descrizione	pagina	descrizione	pagina	descrizione	pagina
Kit pinzette chirurgiche	C42	Manici per bisturi - a doppio taglio	C26	Pinze per tessuti	D44	Portaimpronta forati in alluminio per implantologia	J38
Kit pinzette per medicazioni	B4		E7		E29	Portaimpronta in policarbonato	J42
Kit portaimpronta (alluminio)	J37		E8		G30	Portaimpronta in policarbonato per edentuli	J43
Kit portaimpronta forati in acciaio inox	J13	Manici per bisturi - lama orientabile	C24	Pinze per uncini	F9	Portaimpronta monouso in plastica	A23
	J16		E9	Pinze per uncini - AsaLady	F9	Portaimpronta non forati in acciaio inox	J32
	J17	Manici per specchietti	B19	Pinze per uncini (Vision)	F2		J34
Kit portaimpronta forati in acciaio inox - anatomic	J15	Manici per specchietti - modello Americano	B19	Pinze porta tamponi - curve	C32	Portaimpronta non forati in acciaio inox - ANATOMIC	J34
Kit portaimpronta forati in acciaio inox - depressi anteriormente	J10		B20	Pinze porta tamponi - rette	C32	Portaimpronta non forati in acciaio inox - depressi anteriormente	J28
Kit portaimpronta forati in acciaio inox - PERMA-LOCK	J5	Mantelline protettive	A19	Pinze tiralingua	C33	Portaimpronta non forati in acciaio inox - NEW SUPER	J20
	J7	Marker per bracket	H36	Pinze toglì lama	C24		J30
	J9	Martelli	E16		E9	Portaimpronta non forati in acciaio inox - PERMA-LOCK	J22
Kit portaimpronta forati in acciaio inox per edentuli	J11		K31	Pinzette chirurgiche	C38..C43		J24
	J19		G29		E36	Portaimpronta non forati in acciaio inox - PERMA-LOCK anatomic	J24
Kit portaimpronta forati in alluminio - ORTHOBABY per bambini	J39	Mascherine chirurgiche	A14		K19	Portaimpronta non forati in acciaio inox - PERMA-LOCK high grip	J26
Kit portaimpronta forati in alluminio per implantologia	J38	Matrici	F47	Pinzette per elastici	H36	Portaimpronta non forati in acciaio inox per edentuli	J29
Kit portaimpronta in policarbonato per edentuli	J43	Misuratori di profondità	E32	Pinzette per laboratorio	K19	Portaimpronta occlusali parziali in acciaio inox	J40
Kit portaimpronta non forati in acciaio inox	J33	Mortai per amalgama	F20	Pinzette per marcare le tasche	B3	Portaimpronta ortodontici in policarbonato - ORTHOBABY per bambini	J42
Kit portaimpronta non forati in acciaio inox - anatomic	J21	Mortai per osso	E32		E35		
	J31	Mucotomi - curvi	E26		G31	Pozzetti	A21
	J35	Mucotomi - dritti	E26	Pinzette per medicazioni	B3..B5	Raschietti per osso - curvi	E28
Kit portaimpronta non forati in acciaio inox - depressi anteriormente	J28	Olio	D71		K19	Raschietti per osso - retti	E28
			I12	Pinzette per medicazioni (AsaLady)	B5	Rastrelliere - per 10 posti - Arancione - silicone	I3
Kit portaimpronta non forati in acciaio inox - PERMA-LOCK	J23	Osteotomi	E18..E20	Pinzette per membrana	E37	Rastrelliere - per 10 posti - Blu - silicone	I3
	J25	Otturatori - Brunitori	F31	Pinzette porta impianti	E37	Rastrelliere - per 10 posti - Rosso - silicone	I3
	J27		F49	Porta aghi	C10..C19	Rastrelliere - per 10 posti - Verde - silicone	I3
Kit portaimpronta non forati in acciaio inox per edentuli	J29	Otturatori per amalgama	F26..F30		E5	Rastrelliere - per 5 posti - Arancione - silicone	I3
Kit portauncini + uncini Vision	F2		F48	Porta aghi - modelli leggeri	E6	Rastrelliere - per 5 posti - Blu - silicone	I3
Kit prima visita	A21		F49	Porta aghi - con forbice	C14	Rastrelliere - per 5 posti - Rosso - silicone	I3
	B22	Otturatori per canali	B13..B15		C10	Rastrelliere - per 5 posti - Verde - silicone	I3
Kit prima visita (AsaLady)	B22	Parti di ricambio per cassette - pomelli completi di rondelle	I3	Porta aghi - modelli leggeri	C14	Rotoli per sterilizzare	A13
Kit prima visita (Magic Color)	B23	Pennarelli Vision	F3	Porta aghi - con forbice	C16	Rulli in cotone	A12
Kit sindesmotomi	D69	Pennelli per ceramica	K20	Porta aghi - movimento leggero	C15	Salviette (AsaRainbow)	A6. A7
Kit sindesmotomi	D69	Periotomi	E29	Porta aghi - punte curve	C17..C19	Scalers	G4..G8
Kit sonde	B7		D68		E6		G14
Kit spatole	F22	Piastre millimetriche per endodonzia	B15	Porta aghi - punte lisce	C13		G15
Kit spatole (AsaLady)	F24	Pietre per affilare	G32		C19		G24
Kit strumenti per cera	K18		G33	Porta aghi (AsaLady)	C18	Scalers - destri	G15
Kit strumenti per composito	F32	Pietre per affilare - grana fine	G32		C11	Scalers - sinistri	G15
	F51	Pietre per affilare - grana media	G32	Porta frese	C12	Scalpellini chirurgici	F18
Kit strumenti per modellazione	K17	Pinze emostatiche - AsaLady	C21		E34		G26
Kit strumenti per otturazione	F29	Pinze emostatiche - curve	C20	Porta frese	I17	Scalpellini chirurgici - TG	G26
Kit strumenti per sollevamento seno mascellare	E40	Pinze emostatiche - rette	C20..C23	Porta frese - coperchi	E34	Scalpellini e sgorbie per parodontologia	G27
Lame per bisturi	C26		F44	Porta frese (alluminio)	I17	Scalpellini e sgorbie per parodontologia	G28
	C27	Pinze ossivore	D42..D44		E34		
	E8		E30	Porta matrici	I17	Scalpellini Freer taglio singolo	E16
Lame per bisturi - micro	C27, E9		G30		F46	Scalpellini graduati - curvi	E17
Lame per bisturi (AsaLady)	C26	Pinze per cilindri e muffole	K32	Porta vassoi in alluminio	F47	Scalpellini graduati - retti	E17
	E7	Pinze per estrazione	D4..D20	Portaimpronta forati in acciaio inox	I13	Scollaperiostio	E22
Lampade ad alcool	I19		D24		J12		G16
Lampade ad alcool (accessori)	I19	Pinze per estrazione - AsaLady	D21..D23	Portaimpronta forati in acciaio inox - ANATOMIC	J14	Scollaperiostio ed Elevatori	E24
Leve per frammenti di radici	D64		D29..D31	Portaimpronta forati in acciaio inox - depressi anteriormente	J10		E25
Leve per radici	D45..D63	Pinze per estrazione - manico anatomico	D33..D36	Portaimpronta forati in acciaio inox - PERMA-LOCK	J4	Seghetti	K33
Lime	G22	Pinze per estrazione forma americana	D25..D28	Portaimpronta forati in acciaio inox - PERMA-LOCK anatomic	J6	Set Laboratorio	K34
Lime (Asa Light)	G22	Pinze per estrazione per bambini	D37..D39		J8		K35
Lime per alveolotomia	E21	Pinze per forare la diga	F8	Portaimpronta forati in acciaio inox - PERMA-LOCK con bordo ritentivo	J4	Sindesmotomi	D65..D67
	G23	Pinze per forare la diga - AsaLady	F8		J6	Sindesmotomi (AsaLady)	D65
Lubrificanti per strumenti	D71	Pinze per forare la diga - Vision	F2	Portaimpronta forati in acciaio inox - Ehricke	J16	Siringhe	C28..C30
	I12	Pinze per ortodonzia	H10..H33		J17	Siringhe monouso	A20
Macinatori per osso	E27	Pinze per pannolino	C31	Portaimpronta forati in acciaio inox per edentuli	J11	Soluzioni per la rimozione di alginato (AsaClean)	J40
Manici per bisturi	C26	Pinze per radici	D40		J18	Sonde doppie	B8
	C27	Pinze per radici e frammenti e coni d'argento	B16	Portaimpronta forati in alluminio	J36		B9
	E7		D41	Portaimpronta forati in alluminio - ORTHOBABY per bambini	J39		B11
	E8	Pinze per sterilizzazione	I13	Portaimpronta forati in alluminio colorate per implantologia	J41		

descrizione	pagina
Sonde millimetriche parodontali	E32 G3
Sonde per canali	B9 B10
Sonde seno mascellare	C37
Sonde singole	B6
Spatole	F23 F24
Spatole (AsaLady)	F24
Spatole (cemento)	F22
Spatole (gesso, alginato, elastomeri)	K24..K26
Spatole per miscelazione	A21
Specchietti	B18 B20
Specchietti - modello Americano	B20
Specchietti - rodio	B18
Specchietti - titanio	B18
Specchietti parallelizzatore con manico	B19
Specchietti per fotografie	B17
Specchietti ultralight	B21
Spessimetri per osso	E31
Spingi amalgama	F21
Strumenti accessori per conservativa	F39
Strumenti accessori per ortodonzia	H34..H36
Strumenti da smalto - finitori per bordi gengivali	F18 F19
Strumenti da smalto - finitori per bordi gengivali - distali	F18 F19
Strumenti da smalto - finitori per bordi gengivali - mesiali	F19
Strumenti da smalto - preparazione cavità	F18
Strumenti da smalto - scalpelli	F18
Strumenti per ceramica	K21
Strumenti per ceramica e resine di rivestimento	K21 F49
Strumenti per ceramica e resine di rivestimento (punte)	K18
Strumenti per composito	F32 F50
Strumenti per corone	F40..F43 K29
Strumenti per corone - retti e curvi	F43
Strumenti per elastici	H35
Strumenti per endodonzia	B16
Strumenti per legature	H35
Strumenti per modellare	F36..F38 K13
Strumenti per modellare amalgama/cera	F27 F29 F35 F36 F38 K13
Strumenti per modellare cera	K14..K17 F48 F50
Strumenti per modellare cera (in alluminio)	K17
Strumenti per modellare e rifinire otturazioni	F36 F37 K13
Strumenti per modellare e rifinire otturazioni - cleoide-discoide	F38
Strumenti per modellare e rifinire otturazioni - interprossimale off-angle	F37 F48
Strumenti per otturazioni plastiche	F33..F35 F48 F50

descrizione	pagina
Strumenti per parodontologia	G30
Strumenti per rialzo del seno mascellare	E13..E15
Tazze per alginato e gesso	K26
Telai per diga - acciaio	F9
Telai per diga - plastica	F9
Telai per diga - Vision	F2
Tronchesi	H4..H9
Uncini per diga (con alette)	F4..F7
Uncini per diga (dentellati con alette)	F5..F7
Uncini per diga (senza alette)	F5..F7
Uncini per diga (Vision - Xlayer)	F2
Valigie portastrumenti e pinze	D71
Valigie portastrumenti e pinze (inserti)	D71
Vassoi forati in alluminio	I9
Vassoi in alluminio	I8 I10 I11
Vassoi in plastica	A10 A11
Vassoi magnetici in acciaio inox per uncini (Vision)	F2
Vassoi per endodonzia	I16
Vassoi porta pinze	I12
Vassoi portastrumenti in acciaio inox - coperchio forato	I4 I6
Vassoi portastrumenti in acciaio inox - coperchio non forato	I4 I6 I7
Vassoi portastrumenti in acciaio inox - per 16 strumenti	I5
Vassoi portastrumenti in acciaio inox - per 16 strumenti	I4 I5
Vassoi portastrumenti in acciaio inox - per 23 strumenti	I5
Vassoi portastrumenti in acciaio inox - per 23 strumenti	I4 I5
Vassoi portastrumenti in acciaio inox - per 4 strumenti	I7
Vassoi portastrumenti in acciaio inox - per 4 strumenti	I7
Vassoi portastrumenti in acciaio inox - per 7 strumenti	I6
Vassoi portastrumenti in acciaio inox - per 7 strumenti	I6
Vassoi portastrumenti in acciaio inox - per 8 strumenti	I7
Vassoi portastrumenti in acciaio inox - per 8 strumenti	I7
Vassoi portastrumenti in acciaio inox - vassoio forato	I4 I6
Vassoi portastrumenti in acciaio inox - vassoio non forato	I5..I7
Vision - diga e accessori per isolamento dentale	F2

©2020 Asa Dental S.p.A.

In questo catalogo possono essere presenti errori tipografici, inesattezze o omissioni relative a caratteristiche di prodotto, specifiche tecniche, misure, quantità, configurazioni e altre informazioni.

Asa Dental non si assume alcuna responsabilità legale in merito all'accuratezza o alla completezza delle informazioni riportate, da intendersi unicamente come indicazioni generali.

Asa Dental si riserva il diritto di modificare, sostituire o eliminare prodotti senza preavviso al fine di migliorarne le caratteristiche tecniche o la qualità.

Consigliamo di consultare regolarmente il nostro sito web e di considerarlo la fonte attendibile di informazioni aggiornate in merito a disponibilità di prodotti, specifiche tecniche, procedure e istruzioni d'uso. In alternativa, suggeriamo di contattare il nostro servizio clienti.

L'uso di immagini, disegni e simboli disponibili in questo catalogo è soggetto ad approvazione da parte di Asa Dental e può essere utilizzato solo come supporto per materiale pubblicitario e promozionale dell'azienda e dei suoi prodotti.

Asa Dental, AsaOne, AsaLady, AsaFresh, AsaClean, AsaLight, Perfection, Vision, Leonardo, Leonardo Light, Magic Color, Asa Codicolor, Perma-Lock sono tutti marchi registrati di Asa Dental.

SEDE LEGALE

Asa Dental S.p.A.

Via Valenzana di Sopra, 60 - Bozzano
55054 Massarosa (Lu) - Italy
Tel. +39 0584 938305 - 93363 - 938306
Fax +39 0584 937167
asadental@asadental.it
www.asadental.com

CENTRO LOGISTICO

Via Sarzanese Valdera, 1331 - Bozzano
55054 Massarosa (Lu) - Italy

STABILIMENTI PRODUTTIVI

Via delle Piagge, 1/A - Marlia
55014 Capannori (Lu) - Italy

Via Fierla, 13 - Z.I.
33085 Maniago (Pn) - Italy

FILIALI

Asa Dental USA Corp.

105 Maxess Road, Suite 124
Melville, New York 11747 - USA

Asa Dental CHINA CO. LTD.

Room 315, Huaying Building,
Zhong Xin Avenue
Tianjin Airport Economic Area
Tianjin - China

Asa Dental S.p.A. (Branch)

Dubai South Business Center
Building C, 3rd Floor
Dubai Logistics City
PO Box 390667
Dubai - UAE

**ASA DENTAL**

MAKE PEOPLE SMILE